

Cornell University Library
Ithaca, New York

BOUGHT WITH THE INCOME OF THE
SAGE ENDOWMENT FUND

THE GIFT OF
HENRY W. SAGE

1891

The date shows when this volume was taken.

JAN 13 1936

JAN 13 1938

HOME USE RULES

All books subject to recall

All borrowers must register in the library to borrow books for home use.

All books must be returned at end of college year for inspection and repairs.

Limited books must be returned within the four week limit and not renewed.

Students must return all books before leaving town. Officers should arrange for the return of books wanted during their absence from town.

Volumes of periodicals and of pamphlets are held in the library as much as possible. For special purposes they are given out for a limited time.

Borrowers should not use their library privileges for the benefit of other persons.

Books of special value and gift books, when the giver wishes it, are not allowed to circulate.

Readers are asked to report all cases of books marked or mutilated.

Do not deface books by marks and writing.

Cornell University Library

arV1065

Practical physical chemistry /



3 1924 031 181 393

oiiin,anx

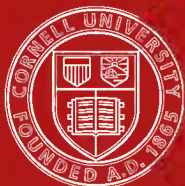

Cornell University Library

The original of this book is in
the Cornell University Library.

There are no known copyright restrictions in
the United States on the use of the text.

PRACTICAL PHYSICAL CHEMISTRY

BY THE SAME AUTHOR

CHEMISTRY IN THE SERVICE
OF MAN.

With 3 Portraits, and Diagrams in the Text.
8vo.

THE PHASE RULE AND ITS
APPLICATIONS.

With 134 Figures in the Text. Crown 8vo.
(*Text-Books of Physical Chemistry.*)

PHYSICAL CHEMISTRY AND ITS
APPLICATIONS IN MEDICAL
AND BIOLOGICAL SCIENCE.

8vo.

OSMOTIC PRESSURE.

With 2 Figures in the Text. 8vo.

(*Monographs on Inorganic and Physical
Chemistry.*)

LONGMANS, GREEN & CO.

LONDON, NEW YORK, BOMBAY, CALCUTTA, AND MADRAS

PRACTICAL PHYSICAL CHEMISTRY

BY
ALEX. FINDLAY, M.A., PH.D., D.Sc.
PROFESSOR OF CHEMISTRY, THE UNIVERSITY, ABERDEEN



WITH ONE HUNDRED AND FOUR FIGURES IN THE TEXT

NEW IMPRESSION

LONGMANS, GREEN AND CO.
39 PATERNOSTER ROW, LONDON
FOURTH AVENUE & 30TH STREET, NEW YORK
BOMBAY, CALCUTTA, AND MADRAS

1920

All rights reserved

PREFACE TO THE THIRD EDITION

WHILE maintaining the essential character of the book as that of a guide to the more fundamental practical methods and experimental foundations of Physical Chemistry, for the use of the general student of Chemistry, the attempt has been made to extend the limits of the work so as to make it of service also to the increasingly large number of students who now devote themselves more especially to this branch of science. Several fresh subjects of study and new experimental methods have therefore been added, such as the determination of vapour densities by the methods of Blackman and of Menzies, and the application of vapour density determinations to the analysis of binary mixtures of normal liquids (Chap. III.); the electrical heating and control of thermostats (Chap. IV.); the measurement of surface tension by the drop method (Chap. V.); the determination of the molar weight of dissolved substances by measurements of the vapour pressure (Chap. VII.); the determination of the solubility of sparingly soluble salts and of the hydrolysis of salts by conductivity measurements (Chap. IX.); the measurement of decomposition and of ionic discharge potentials (Chap. XI.); and the solubility of gases in liquids and of liquids in liquids (Chap. XIV.).

Owing to the larger amount of time which is now

frequently devoted to practical physical chemistry, I have, in recent years, felt the necessity of referring the more advanced students to the original literature for the purpose not only of providing further experimental practice, but also, more especially, of enabling them to obtain a fuller knowledge of the precautions to be observed in accurate work, and of the degree of accuracy obtainable with a given piece of apparatus. I have, in consequence, added to most of the chapters a number of references to the literature—which must not, however, be regarded as in any way exhaustive—by means of which the experiments and discussions given in the following pages, may be supplemented.

An Appendix has also been added giving tables of some of the more important physical data, so far as they are required in connection with the course of practical work given here. For further data reference may be made to the excellent and convenient set of *Physical Tables* compiled by Kaye and Laby, or to the much larger Tables of Castell Evans or of Landolt-Börnstein-Meyerhoffer, and the Annual Tables of Data, Physical, Chemical and Technological, now published.

A. F.

August, 1914.

P R E F A C E

DURING recent years it has come to be more widely recognized in our Universities and Colleges that the course of study for students of Chemistry, no matter to what special branch of the subject they may intend to devote themselves later, cannot be regarded as complete or satisfactory unless it include both systematic and practical Physical Chemistry. While, however, the student of practical Inorganic or Organic Chemistry has at his command an abundant supply of text-books, both elementary and advanced, the student of practical Physical Chemistry has hitherto been forced to rely, almost entirely, on the text-book of Ostwald or Ostwald and Luther. Although this forms in every way an admirable guide and book of reference for the advanced worker in Physical Chemistry, it has not proved itself suitable as a text-book for the general student of Chemistry, whose chief desire is to obtain some knowledge of the experimental foundations of the subject. It is, no doubt, to the lack of a suitable elementary text-book in which the student of Physical Chemistry can find sufficiently detailed guidance and direction in the carrying out of the more important physico-chemical measurements, that the complete or almost complete omission of practical Physical Chemistry from the ordinary course of chemical study in many of our British Universities and Colleges is largely due.

For several years practical Physical Chemistry has formed part of the regular laboratory course for students of Chemistry in the University of Birmingham; and it is primarily for the benefit of these students that the present book has been written. It is hoped, however, that the volume may be of value for other students also, and may help to promote the more general introduction of Physical Chemistry into the courses of study in our Universities.

In making the choice of experiments described in the following pages, regard has been had to the requirements of the general student of Chemistry, and for this reason only typical methods and experiments, or such as are of fundamental importance in the study of Physical Chemistry, have been selected. The experiments are therefore designed, as supplementary to the more or less qualitative demonstrations in the lecture-room, not only to familiarize the student with the chief methods of experimentation and to assist him in understanding the general laws and principles of Physical Chemistry, but also to establish these more firmly in his memory.

With regard to the order of treatment of the different subjects, I have followed, for the most part, that adopted in my lecture course. But it is by no means necessary that the student should carry out the experiments in the order they are here described. The different chapters are, as far as possible, independent one of the other, and full freedom is therefore left to the teacher to take up the subjects in what order he may consider best.

Where the time that can be devoted to practical Physical Chemistry is limited, it may be found impossible for each student to perform all the experiments described in the

following pages. In such cases it is very advantageous to group related experiments together, and to apportion the experiments among a group of students. Thus, for example, one student might determine the molar weight of camphor in benzene (p. 133); another, the apparent molar weight of benzoic acid in benzene (p. 136); while a third might determine the apparent molar weight of sodium chloride in water (p. 137). In this way, each student would learn the method of molar weight determination by the freezing-point method; and by comparing his results with those obtained by his fellow-students would obtain a very good idea of the principles involved in the different experiments carried out by them. This method of working enables each student to cover more ground than he otherwise would do, and is much more satisfactory than allowing two or more students to carry out one and the same experiment in common.

In conclusion, I would express my indebtedness to the text-book on Physical Chemical Measurements by Ostwald and Luther, to which all advanced students may be referred; and I would also thank my colleague Dr. A. du Pré Denning, not only for his assistance in reading the proof-sheets, but also for the friendly criticism which he was good enough to offer.

A. F.

UNIVERSITY OF BIRMINGHAM,
November, 1906.

PREFACE TO THE SECOND EDITION

ALTHOUGH no alteration has been made in its fundamental character, the first edition has been subjected to a careful revision, whereby, it is hoped, errors and ambiguities have been reduced to a minimum. In this connection the author gratefully acknowledges the assistance which he has received from those colleagues in other Institutions who have drawn his attention to such errors and omissions as have come under their notice. A continuance of such co-operation will be very greatly appreciated.

Here and there in the text small additions have been made, the treatment of the important subject of transport numbers has been extended. Tables of atomic weights, and of four-place logarithms from Mr. Castle's "Mathematical Tables" published by Messrs. Macmillan and Co., have also been added as appendices. These additions, it is hoped will increase the usefulness of the work.

October, 1909.

CONTENTS

CHAPTER I

CALCULATION OF RESULTS AND ERRORS	PAGE 1
---	-----------

Number of figures to be employed, 1. Calculations with approximate numbers, 3. Methods of calculation, 6. Abbreviated multiplication, 6. Abbreviated division, 9. Logarithms, 12. The slide rule, 12. Errors, 13. Influence of errors of observation on the final result, 14. Determination of the error of observation, 17.

CHAPTER II

DETERMINATIONS OF WEIGHT AND VOLUME	19
---	----

The Balance, 19. Determination of the zero point, 20. Rule, 21. Sensitiveness of a balance—Weighing by oscillations, 22. Calibration of weights, 24. Correction for the buoyancy of the air, 27. Calibration of volumetric apparatus, 29. Calibration of measuring flasks, 30. Marking a ring on the neck, 32. Calibration of pipettes, 32. Calibration of burettes, 35. Parallax, 38.

CHAPTER III

DENSITY OF LIQUIDS AND GASES	39
--	----

A.—Density of liquids, 39. Calculation of the density, 43. B.—Density of gases and vapours, 45. Determination of the density of a gas, 45. Determination of vapour density, 49. Other methods of determining vapour densities, 58. Apparatus of Blackman, 59. Apparatus of Menzies, 62. Associating and dissociating substances, 64. Analysis of Binary mixtures, 66.

CHAPTER IV

	PAGE
THERMOSTATS	68
The bath, 69. Constant level apparatus, 70. Regulation of the temperature, 71. Filling and adjusting the thermo-regulator, 73. Stirrers, 76. Fitting up a thermostat, 78. Circulation of water, 79. Electrically heated and controlled thermostats, 80.	

CHAPTER V

VISCOSITY AND SURFACE TENSION	83
A.—Viscosity, 83. B.—Surface tension, 88. Apparatus, 90. Drop method, 93. Traube's stalagmometer, 94.	

CHAPTER VI

OPTICAL MEASUREMENTS	97
A.—Refractometric measurements, 97. Refractive index, 97. Determination of the refractive index of a liquid, 97. Specific and molecular refractivity, 98. Monochromatic light, 99. Regulation of the temperature, 100. Pulfrich refractometer, 101. Determination of the zero point, 103. Correction for temperature, 108. Refractivity of substances in solution, 111. B.—Polarimetric measurements, 112. Apparatus, 114. Source of illumination, 117. Observation tubes, 117. Adjustment of the polarimeter, 118. C.—Spectrometry, 119. Spectrometer, 120. Adjustment of the spectrometer, 120.	

CHAPTER VII

MOLAR WEIGHT OF SUBSTANCES IN SOLUTION	125
I.—Freezing-point (cryoscopic) method, 125. Apparatus, 126. Precautions, 127. The Beckmann thermometer, 129. Setting the Beckmann thermometer, 130. Tabloid press, 132. Abnormal molar weights, 135. II.—Boiling-point (ebullioscopic) method, 138. Apparatus and method, 139. Manipulation, 140. Method of electrical heating, 143. Laudsberger-Walker method, 143. Apparatus, 144. Carrying out a determination, 145. Apparatus of McCoy, 147. Carrying out a determination, 147. III.—Lowering of the vapour pressure, 149. Apparatus, 150. Carrying out a determination, 150.	

CHAPTER VIII

	PAGE
DISTRIBUTION OF A SUBSTANCE BETWEEN TWO NON-MISCIBLE SOLVENTS	153

I.—The solute has the same molar weight in each of the solvents, 153. II.—The molar weight of the solute in the two solvents is different, 155. Determination of the molar weight of dissolved substances, 156. Determination of the degree of hydrolysis of salts, 158. Preparation of water free from carbonic acid, 161. Preparation of standard baryta solutions, 162.

CHAPTER IX

CONDUCTIVITY OF ELECTROLYTES	165
--	-----

Outline of method and apparatus, 167. Platinizing the electrodes, 171. The measuring bridge, 173. Calibration of the bridge wire, 174. Conductivity water, 179. The cell constant, 180. Degree of ionization and ionization constant, 190. Basicity of acids, 196. Determination of the neutralization point by conductivity, 199. Solubility of sparingly soluble salts, 202. Hydrolysis of salts, 203.

CHAPTER X

TRANSPORT NUMBERS	206
-----------------------------	-----

CHAPTER XI

MEASUREMENTS OF ELECTROMOTIVE FORCE	213
---	-----

Measurement of the e.m.f. of a cell—Outline of the method, 214. Apparatus, 215. Purification of mercury, 218. Seat of electromotive force of a cell, 226. Measurement of single electrode potentials, 227. Electrode potentials, 230. Influence of concentration, 237. Concentration cells, 239. Solubility measurements, 241. Gas cells, 242. Ionization of water, 248. Decomposition potential of salts, 251.

CHAPTER XII

VELOCITY OF CHEMICAL REACTION IN HOMOGENEOUS SYSTEMS PAGE
256

A.—Reactions of the first order. Hydrolysis of an ester in presence of an acid, 258. Velocity of inversion of cane sugar, 262. Application, 265. Decomposition of diazonium salts, 267. B.—Reactions of the second order—Saponification of esters by alkalis, 270. Order of a reaction, 272.

CHAPTER XIII

THERMO-CHEMISTRY 275

Apparatus, 275. Units, 276. A.—Heat of neutralization of acids and bases in dilute solution, 278. Calculation of the heat of neutralization, 281. B.—Heat of solution, 283. C.—Heat of combustion, 285. The bomb, 286. The calorimeter, 288. Making a determination, 288. Correction of temperature for radiation, 291.

CHAPTER XIV

DETERMINATION OF SOLUBILITY 294

Solubility of a gas in a liquid, 294. Solubility of a liquid in a liquid, 298. Solubility of solids in liquids, 301. Determination of the solubility, 302.

CHAPTER XV

DETERMINATION OF TRANSITION POINTS 307

Determination of the transition point, 308. 1. Solubility method, 308. 2. Thermometric method, 308. 3. Dilatometric method, 309. 4. Tensimetric method, 313.

APPENDIX 317

International atomic weights, 317. Transition points of salt hydrates, 318. Heating liquids, 318. Viscosities of liquids, 318. Surface tension of liquids, 319. Ionic conductivities at infinite dilution, 319. Logarithm tables, 320.

INDEX 323

PRACTICAL PHYSICAL CHEMISTRY

CHAPTER I

CALCULATION OF RESULTS AND ERRORS

SINCE it is only in rare cases that the numerical value of a physical property can be directly determined, it becomes necessary to *calculate* the value of the property from the different observations and measurements which have been made. Although this operation may necessitate the use of only simple arithmetical processes, both the method of calculation and the manner of expressing the result demand attention if one is to avoid useless labour and at the same time give correct and significant expression to the results of the measurements performed.

Number of Figures to be Employed.—Probably one of the first difficulties which confronts a beginner is to decide how many figures are to be employed; for it is just as easy, and apparently more natural, to make the mistake of using too many as of using too few figures. Thus, in carrying out, say, the process of multiplication or division with two numbers, it appears to be very difficult for one to get rid of the idea that the greater the number of places to which the result is calculated, the more accurate must it be. However this may be with regard to the purely arithmetical value of the result, increase beyond a certain point in the number of figures intended

to represent the value of an experimentally determined physical property is a useless waste of labour.

Since every measurement involves a certain error, or can be carried out only with a certain degree of accuracy, it is evident that the number expressing the value of a property depending on the measurement can only be approximate. However many figures we write down, therefore, as the result of our calculation, we cannot increase the accuracy of the value beyond that determined by the errors of the measurements. But, on the other hand, if we write down too few figures, the statement of the result may be much less accurate than the measurements allow. We have therefore to choose the number of figures in our result such that they indicate the limit of accuracy of which the measurements are capable. The result should therefore be expressed by such a number of figures that all, except the last, are known with certainty; but that while the last figure is uncertain, the error is not greater than ± 5 in the following place. This constitutes the *maximum apparent error* of the number.

Thus, for example, in reading a burette, the error in reading may be taken at about 0.01 c.c. If, therefore, we wrote down as the result of a reading, say, 22.4 instead of 22.40 c.c., we should be committing the mistake of writing too few figures; for, according to the rule given, the number 22.4 would indicate that the true value lay between 22.35 and 22.45, and the apparent error is therefore five times greater than the error of measurement. On the other hand, if, in taking the mean of the readings 22.38, 22.40, 22.42, 22.39, we wrote the result 22.397, we should commit the error of writing too many figures, for this would indicate that the error of measurement is only about ± 0.001 c.c. The number should therefore be rounded off to 22.40. For the purposes of further calculation, however, one employs one figure more, *i.e.* one would use 22.397.

Calculations with Approximate Numbers.—Having decided the number of figures to be used in expressing the result of a given measurement, the question still remains as to how many figures are to be retained in a final result obtained with these approximate numbers by the processes of addition, subtraction, multiplication, or division.

In the case of *addition* and *subtraction* of approximate numbers, the greatest apparent error in any of the numbers gives the maximum apparent error in the final result. Thus, if the different numbers have all the same apparent error, the result will also have this apparent error.

For example, in the addition—

$$\begin{array}{r} 22\cdot4 \\ 120\cdot1 \\ \hline 142\cdot5 \\ \hline \end{array}$$

the maximum apparent error in each of the numbers is $\pm 0\cdot05$; and this is also the maximum apparent error in the result, because the errors in the two numbers of the sum may have the same or opposite signs with equal probability, and may therefore with equal probability increase or cancel each other.

If, however, we have the addition—

$$\begin{array}{r} 22\cdot4 \\ 120\cdot106 \\ 12\cdot2245 \\ \hline 154\cdot7305 \\ \hline \end{array}$$

the maximum apparent error in the result must be $\pm 0\cdot05$, which is the greatest apparent error in any of the single numbers ($22\cdot4$). Consequently there is a derived error of 5 units in the figure 3, and the result ought therefore to be written

154.7; although if the number is to be used in further calculations it is better to retain, as is usual, one figure more, *i.e.* to use 154.73.

Not only should one not write all the figures 154.7305 as the final result, but one should seek to acquire the habit of not writing down the unnecessary figures in the numbers to be added. Thus, instead of writing 120.106 one should write 120.11; and instead of 12.2245 one should write 12.22. In these cases the second figure of the decimal is retained in order to avoid introduction of fresh errors in rounding off the number.

With regard to this operation of *rounding off* a certain number, the rule is that if the number in the place following the last to be retained is equal to or greater than 5, one unit should be added to the last place retained. Thus, if we wished to retain only the second place of decimals, we should make 12.224 into 12.22, 12.225 into 12.23.

In the case of *multiplication* and *division* of numbers, we are concerned only with the *relative errors* or *proportional errors* in the numbers, not with the apparent or the absolute errors; and we have to remember that a given relative error in the numbers will produce a corresponding relative error in the result. Thus, in determining the area of a rectangle, if we find by measurement that the sides are equal to 100.0 and 10.0 cm. respectively, there is a possibility of error in measurement in both cases. If both lengths have been measured with the same absolute error, say 0.1 cm., then the relative errors in the two measurements will be 0.1 and 1.0 per cent. respectively. But if the correct lengths were 100.0 and 10.1 cm. respectively, the area would be not 1000 sq. cm., but 1010 sq. cm., or 1 per cent. greater. If the lengths were 100.0 and 9.9 cm. respectively, the area would be 990 sq. cm., which again differs from the number 1000 by one-hundredth of the total value, *i.e.* by 1 per cent.

It will, of course, be quite evident that the error in the final area caused by the possible error in the length of 100.0 cm. can amount to only 0.1 per cent; that is, it is negligible as compared with the much greater error produced by the uncertainty of the number 10.0. Whenever, therefore, in an operation involving the multiplication of factors, the relative error in one is much greater, say from five to ten times greater than the relative errors in the other factors, the latter errors may be neglected altogether, and the error in the result will be determined only by the greatest relative error in the factors.

Suppose therefore that we have to multiply 2.3416 by 2.55, and suppose each of these numbers to have the maximum apparent error; then the relative error in the first number is 5 in 230,000, and the error in the second number is 5 in 2600. Evidently, therefore, the result of the multiplication will also have an error of about 5 in 2600, or 0.2 per cent. Consequently it would be quite incorrect to perform the multiplication in the ordinary manner, and write the result as 5.971080; for this result has a derived error of 0.2 per cent., or of about 1 unit in the second place of decimals. All the figures after this are therefore meaningless, and should be discarded, the result being written 5.97.

What has been said with regard to multiplication holds equally for division; for in this case also, the greatest relative error in divisor or dividend, if it be five or ten times greater than the other relative errors, will determine the relative error in the result. (See also p. 16).

EXAMPLE—

$$\frac{1.45 \times 5.680}{10.234} = 0.80477. . . .$$

Since 1.45 contains the greatest relative error, viz. 5 in 1500, or about 0.3 per cent., the final result will have an equal relative error from this cause. Hence there will be an error

of about 2 units in the third place of decimals, or, in other words, the 4 is somewhat uncertain. We may therefore write the result 0.805; and for further calculations we may use 0.8048.

Methods of Calculation.—From what has just been said, it will be seen that calculations carried out in the ordinary way frequently involve the manipulation of a number of useless figures, and that several of the figures obtained as the result of laborious calculation are afterwards discarded altogether as meaningless. We are therefore led to consider whether this useless expenditure of energy may not be avoided.

In the first place, much labour may be avoided by adopting an abbreviated method of multiplication and division; and in the second place, labour-saving methods of calculation, *e.g.* calculation by means of logarithms or by the slide rule may be employed.

Abbreviated Multiplication.—Suppose that we have to multiply together 2.4321 and 0.4562. If we calculate this, we obtain—

By ordinary multiplication.

$$\begin{array}{r}
 2.4321 \\
 0.4562 \\
 \hline
 48642 \\
 145926 \\
 121605 \\
 97284 \\
 \hline
 \underline{\underline{1.10952402}}
 \end{array}$$

By abbreviated multiplication.

$$\begin{array}{r}
 2.4321 \\
 2654 \\
 \hline
 97284 \\
 12161 \\
 1459 \\
 49 \\
 \hline
 \underline{\underline{1.10953}}
 \end{array}$$

As regards the method of shortened multiplication, first of all, it will be seen that the one number (0.4562) is inverted below the other, and the latter then multiplied by each number

of the second row from right to left, starting the multiplication with the figure directly over the multiplier in the second row. Any fraction equal to or greater than 0.5 obtained from multiplying the preceding figure in the multiplicand should be carried as 1. In each case the first figure of the result is placed under the unit figure of the first multiplication.

In the above case we obtain, by long multiplication, a result with eight decimal places, while, by abbreviated multiplication, there are only five places of decimals. We have, therefore, to see whether the latter result is sufficiently accurate.

We see that the greatest relative error in the factors is about 5 in 50,000 (in the case of the number 0.4562), or an error of 1 in 10,000. This will also give us the error in the result; and, hence, we see that the 5 in the result is uncertain to rather more than 1 unit. The correct result, therefore, should be written 1.1095. We see, therefore, that by the shortened method of multiplication we have obtained the correct number of figures (the 3 being useful if the result is required for further calculations); whereas, in the case of the long method, we have three useless figures.

One or two rules may now be given for carrying out the shortened method of multiplication, so as to obtain a sufficient but not too great a number of figures in the answer:—

1. When the numbers are of equal length (cyphers following immediately after the decimal point being left out of account), one number is inverted under the other, so that the left-hand figure of the inverted number stands under the right-hand figure of the other number. It is immaterial which number is inverted, except when one of the numbers commences with a small figure, 1 up to 3. In this case, the number commencing with the high figure should be inverted. If both numbers commence with a low figure, the inverted number should be moved one place to the right. Thus, 1.021×1.325 .

$$\begin{array}{r}
 1'3250 \\
 1201 \\
 \hline
 13250 \\
 265 \\
 13 \\
 \hline
 \underline{\underline{1'3528}}
 \end{array}$$

The reason for the above method of procedure is to avoid errors in carrying over fractions in the multiplication.

2. If the two numbers are of unequal length, the longer number should be inverted under the shorter. Thus, $0'231 \times 7'4565$ —

$$\begin{array}{r}
 0'231 \\
 56547 \\
 \hline
 1617 \\
 92 \\
 11 \\
 \hline
 \underline{\underline{1'720}}
 \end{array}$$

Since the last two figures of the longer number are not used, they need not be written down at all.

A special case, however, should be mentioned. If the shorter number begins with the figure 5 or a higher figure, it should be inverted below the longer number; and the latter should be rounded off so as to contain only one figure more than the shorter number. Or, if the longer number is inverted, it should be moved one place to the right. Thus, $5'234 \times 9'3$ —

$$\begin{array}{r}
 a. \quad 5'23 \\
 \quad \underline{39} \\
 \quad 4707 \\
 \quad \quad \underline{157} \\
 \quad \underline{48'64}
 \end{array}$$

$$\begin{array}{r}
 b \quad 9'30 \\
 \quad \underline{325} \\
 \quad 4650 \\
 \quad \quad \underline{186} \\
 \quad \quad \quad \underline{28} \\
 \quad \underline{48'64}
 \end{array}$$

Since the apparent error in 9'3 is about 5 in 1000, the result of the multiplication may be written 48'6, and for further calculations we may use 48'64.

Abbreviated Division.—In carrying out abbreviated division, one digit is struck off from the divisor after each operation; and the remainder from the previous division is divided by this new divisor. The digit struck off from the divisor should, however, be taken into account for the purpose of “carrying.” Thus, $0'4265 \div 0'3132$ —

$$\begin{array}{r}
 3132)4265(1362 \quad \text{Result} = 0'1362. \\
 \underline{3132} \\
 1133 \\
 \underline{940} \\
 193 \\
 \underline{187} \\
 6 \\
 6 \\
 \underline{\quad}
 \end{array}$$

This example will illustrate the method. We have still to consider, however, the number of figures in the result. If we consider the two numbers to have the maximum apparent error, we see that the greatest error in divisor or dividend is about 5 in 30,000, or 1 in 6000. The number of significant figures in the result should therefore be such that the error is

not greater than this. In the above example, however, the result shows an error of about 1 in 1400 (in accordance with the rule given for the number of digits, p. 2). The error in the result is therefore too great, and the number of digits too few. The division must therefore be carried further. Thus—

$$\begin{array}{r}
 3132)42650(13617 \quad \text{Result} = 0.13617 \\
 \underline{3132} \\
 11330 \\
 \underline{9396} \\
 1934 \\
 \underline{1879} \\
 55 \\
 \underline{31} \\
 24 \\
 \underline{22} \\
 2
 \end{array}$$

If the dividend is of the same length as, or is shorter than, the divisor, a cypher must be added to it so that the error in the last figure is great. If the dividend so obtained has fewer figures than the product of the divisor with the first figure of the quotient, one or more digits must be struck off from the divisor. Thus, $0.856 \div 0.23354$ —

$$\begin{array}{r}
 23354)8560(3666 \quad \text{Result} = 3.666. \\
 \underline{7006} \\
 1554 \\
 \underline{1401} \\
 153 \\
 \underline{139} \\
 14 \\
 \underline{14} \\
 0
 \end{array}$$

In this example, the 4 of the divisor has not been used.

If the dividend is longer than the divisor, it is only necessary to use so many figures of it that the last figure involves an error considerably less than the error in the divisor. Thus, $4'52346 \div 2'164$. Here the apparent error in the divisor is 5 in 20,000. If we took the dividend as 4'523, the apparent error would be about 5 in 50,000, or about half the error in the divisor. We shall therefore use one figure more, and round off the number to 4'5235. We then obtain—

$$\begin{array}{r}
 2164)45235(20904 \quad \text{Result} = 2'0904. \\
 \underline{4328} \\
 1955 \\
 \underline{1947} \\
 8 \\
 \underline{8} \\
 \hline
 \end{array}$$

With a slight mental exertion, the process of division can be still further shortened by carrying out mentally the multiplication of divisor and quotient, and the subtraction of the product so obtained from the dividend, and only writing the latter result down. Thus, taking our first example again, $0'4265 \div 0'3132$, we have the following—

$$\begin{array}{r}
 3132)4265(1362 \\
 \underline{1133} \\
 193 \\
 \underline{6} \\
 \hline
 \end{array}$$

The mental operations are : first the multiplication, figure by figure, of 3132 by 1, and the subtraction, figure by figure, of the product from 4265. This gives 1133. Now multiply 313(2) by

3, and we get $3 \times 3 = 9$, and carrying 1 from the previous product of $3 \times 2 = 6$, gives (1)0. This subtracted from 3 gives 3; $3 \times 1 = 3$, and carrying 1 gives 4; 4 from (1)3 gives 9; $3 \times 3 = 9$; to this must be added 1 carried in the previous subtraction; so that we get 10 from $11 = 1$. Hence we get the line 193; and so on.

Logarithms.—In making calculations with the aid of logarithms, the precautions adopted in the preceding methods for the avoidance of unnecessary figures, are introduced automatically, if it be so arranged that the number of figures in the logarithm is greater by one than the number of figures in the least accurate of the numbers involved in the calculation. In this way one ensures that the error in the result shall not be greater than the error in the numbers from which the result is obtained. If we had to multiply $2.54 \times 4.3664 \times 0.89676$, we should use 4-place logarithm tables, and the second and third numbers should be rounded off to 4.366 and 0.8968.

The error inherent in the logarithm itself, decreases with the number of places in the logarithm, each additional figure in the logarithm being accompanied by about a tenfold decrease in the error. In the case of 4-place logarithms, the maximum possible error introduced into a calculation through their use may be taken as about 1 in 3000. For work of moderate accuracy, 4-place logarithms will be sufficient; but in some cases, the error so introduced is greater than that due to experiment, *e.g.* determinations of density. In the latter cases, therefore, where the accuracy of the calculation is desired to be equal to the accuracy of the experiment, logarithms with 5 or 6, and even in more exceptional cases, 7 places should be used.

The Slide Rule.—In many of the cases mentioned in the preceding pages, we have been dealing with calculations in which the error involved was much less than that usually found in any but the best experimental work; and in none of the

experiments described in the following pages will an accuracy in calculation be called for greater than can be obtained by the use of 4-place, or, at most, 5-place logarithms. Frequently, the accuracy required will be considerably less.

For all calculations, where the required accuracy of experiment or calculation is not greater than about 1 in 500, the slide rule is of great assistance. With this instrument various degrees of accuracy can be obtained according to the size of the rule, but with the ordinary size of slide rule (25 cms. in length) the accuracy obtainable may be put down at about 1 in 500 to 1 in 800.

Errors.—The determination of the value of a physical property is always liable to errors of various kinds, so that in all cases the result of an observation or measurement is only an approximation to the truth. The two chief kinds of errors are: *constant errors* due to some error in the apparatus, or to the neglect of certain factors which exercise an appreciable effect, and *accidental errors* or *errors of observation*.

In the case of constant errors, the different values of the given magnitude may differ by a very small amount from one another, but may nevertheless differ by a comparatively large amount—the deviations being all in the same direction—from the true value. It is evident, therefore, that increasing the number of determinations will not in that case increase the accuracy of the result; and to exclude the constant errors, it is necessary to vary the method of observation or to alter the conditions of experiment. This also includes calibration of apparatus, purification of materials, etc.

In the case of errors of observation, the results of the different determinations may vary in either direction from the truth, *i.e.* the errors may have a positive or negative effect. Thus, in volumetric analysis the burette readings may fluctuate, so that one obtains such numbers as 20·22, 20·26, 20·24, 20·22, 20·23. We have, therefore, to decide which of these numbers,

lying within the limits 20'22 and 20'26, is nearest to the truth. In all such cases, when we are dealing with a series of measurements of the same property, carried out with the same care, the best representative number is the *arithmetical mean* of the different numbers.

In certain other circumstances, individual errors of observation can be diminished by a graphic method. Thus, in studying the variation of a magnitude with change of condition, e.g. change of viscosity with temperature, or the alteration of the freezing-point of a solution with composition, the best values of the magnitude are obtained by plotting the results, say in rectangular co-ordinates, and drawing a "smooth curve" so as to take in as many of the individual observations as possible.

In this way one can obtain not only the best values of the magnitude under the particular conditions of the experiments, but also under other conditions, by taking the different points on the curves (*Interpolation*). It must, however, be remembered that the numbers near the ends of the curve are liable to greater errors than near the middle, because the position of the curve near its ends becomes doubtful.

Influence of Errors of Observation on the Final Result.—It has already been stated that the value of a magnitude is obtained only by indirect measurement; by the determination, that is to say, of another magnitude to which the first is related in some definite manner. Thus, if we wish to determine the length of the circumference of a circle we can make use of the relationship, circumference = $2\pi r$; and by determining the value of r we can then calculate the value of the circumference. The circumference is therefore given as a product, and as the numbers 2 and π are free from error, it follows from what has previously been said, that the relative error in the final result will be the same as the relative error in r . If we can measure r with an error of only 0.1 per cent., then

the error in the value of the circumference need not be greater than 0.1 per cent. It is necessary, therefore, that the value which we take for π should be correct to less than 0.1 per cent.

But on the other hand, suppose that we wish to determine the area of a circle by means of the relationship, $\text{area} = \pi r^2$, then an error of 0.1 per cent. in the determination of r will cause an error of 0.2 per cent., or twice as great an error, in the result.

Whenever, therefore, the value of a magnitude is proportional, directly or indirectly, to the quantity measured, the relative error in the result will be, numerically, the same as the relative error in the quantity measured.

Thus, if $x \propto y$; an error of $\pm a$ per cent. in y will cause an error of $\pm a$ per cent. in x ; or if $x \propto \frac{1}{y}$, an error of $\pm a$ per cent. in y will cause an error of $\mp a$ per cent. in x .

But when the value of a magnitude is proportional to the n^{th} power of the quantity measured, the relative error in the latter will be magnified n times in the result.¹

In the above cases, we have assumed that the value of a magnitude depends only on the measurement of one quantity. But, in most cases a result is obtained by combining different kinds of measurements, and the accuracy (*i.e.* the relative error) of the final result will depend on the accuracy of the several determinations. Thus, the determination of the molecular weight by the cryoscopic method, involves measurements of weight and of temperature; the determination of the velocity of a reaction involves quantity and time. Now, it will be

¹ These results can be readily obtained by differentiation. Thus, if $x = k \cdot y$, $dx = k dy$, or $\frac{dx}{x} = \frac{k dy}{k y} = \frac{dy}{y}$. That is, the relative error in x ($\frac{dx}{x}$) is equal to the relative error in y ($\frac{dy}{y}$).

Again, if $x = k \cdot y^2$, $dx = k \cdot 2y dy$; and $\frac{dx}{x} = \frac{2k \cdot y dy}{k \cdot y^2} = \frac{2dy}{y}$. That is, the relative error in x is twice as great as the relative error in y .

readily understood that some of these quantities are capable of more accurate measurement than others, but there would be no advantage in determining some of the factors with very great accuracy, if the errors involved in any of the other factors were much greater. This should always be borne in mind, as there is always a tendency to think that the final result can be increased in accuracy by carrying out every measurement with the maximum of accuracy of which it is capable. Remember that the accuracy of the final result is influenced chiefly by the accuracy of the *least accurate* measurement; and if the errors in the other factors are considerably less, say five or ten times less, then they may be neglected altogether.

In carrying out any composite determination, or one involving several different kinds of measurement, one should first of all, before proceeding to carry out the actual determinations, ascertain what is the influence on the result of a given error in each of the individual measurements; so that, on the one hand, special attention may be paid to those measurements having the greatest influence on the result, and, on the other hand, unnecessary excess of accuracy may be avoided in the case of the other measurements.

To do this, write down the expression giving the relation between the final result and the different measurements from which it is obtained, and then, taking each factor in turn and regarding all the others as being constant, determine its influence on the final result as described above. Thus, for the determination of the molecular weight by the cryoscopic method, we have (p. 125) $M = k \cdot \frac{w}{d \cdot W}$, where w and W are weights, and d is a temperature difference. It will be seen from this, that taking each factor, w , W , and d separately, the influence of each on the result is the same. But w and W can be measured with much greater accuracy than d , so that if the relative error in d is, say, 2 per cent., it will not be necessary

to determine w and W with a greater accuracy than $0.2 - 0.4$ per cent. If, therefore, w is about 0.5 gm., and W about 20 gms., the former need not be weighed to less than 1 mgm., nor the latter to less than about 2 cgms.

When the relative error of one of the factors is not considerably greater than that of the other factors, the latter have also their influence on the accuracy of the final result, and it can be shown that the square of the relative error in the final result is equal to the sum of the squares of the relative errors of the individual measurements.

Thus, for the determination of the specific rotation of an optically active substance, we have the formula (Chap. VI.)

$[\alpha] = \frac{\alpha}{l \cdot c}$. Suppose that the error in the determination of $\alpha = 0.05$ per cent.; in the determination of l , 0.01 per cent.; in the determination of c , 0.02 per cent. Then the error produced in the final result will be equal to $\pm \sqrt{(0.05)^2 + (0.01)^2 + (0.02)^2} = 0.055$ per cent. In accordance with what was said before (p. 16) we might neglect the error 0.01 per cent. in comparison with the error 0.05 per cent.

Determination of the Error of Observation.—One point still remains. We have considered the effect of a given error of observation on the final result, and we have now to ask how, in experimental work, the error involved in a given determination is gauged.

The simplest method which we may employ for this purpose is the determination of the average deviation of each observation of a series from the general mean. Thus, in determining the angle of rotation of an optically active substance, the following values were successively read: 27.84° , 27.83° , 27.84° , 27.80° , 27.82° , 27.84° . The mean of these numbers is 27.828° . The deviations of the individual readings from the mean are (neglecting sign): 0.012 , 0.003 , 0.012 , 0.028 , 0.008 , 0.012 . The sum of the six numbers is 0.075 ; and the average deviation

is therefore 0.012° . The error in the determination is therefore rather less than 1 in 2000, or about 0.05 per cent.

The result can be obtained more correctly with the help of the theory of probabilities. On the basis of this theory the mean error which may be taken as attaching to each determination is given by the expression

$$\pm \sqrt{\frac{\Sigma \delta^2}{(n-1)}}$$

where $\Sigma \delta^2$ is the sum of the squares of the deviations of the individual determinations from the mean, and n is the number of the determinations. Applying this in the above case we obtain for the *mean error of each determination*

$$\pm \sqrt{\frac{12^2 + 3^2 + 12^2 + 28^2 + 8^2 + 12^2}{5}} = \pm 16.1$$

in units of the third decimal place; or, the mean error of each determination is $\pm 0.016^\circ$.

On p. 14 it was stated that the best representative value of a series of measurements is the arithmetical mean of the different values. To this mean value, however, is also attached an error, and the mean value of this error, or the *mean error of the mean*, is given by the expression

$$\pm \sqrt{\frac{\Sigma \delta^2}{n(n-1)}}$$

In the case of the above series of measurements, therefore, the mean error of the mean is equal to

$$\pm \sqrt{\frac{12^2 + 3^2 + 12^2 + 28^2 + 8^2 + 12^2}{30}} = \pm 6.6$$

in units of the third decimal place, and this is indicated by writing the final value of the determinations in the form, $27.828^\circ \pm 0.007^\circ$. Increase in the number of separate measurements will diminish the value of this mean error of the mean, but does not diminish the value of the mean error of the individual determinations.

CHAPTER II

DETERMINATIONS OF WEIGHT AND VOLUME

BEFORE engaging on any physical measurement, it is of essential importance either to satisfy one's self that the different apparatus to be employed in the measurements are accurate, within definite limits, or to determine the errors attaching to the apparatus in order that the necessary corrections may be applied. The limit of accuracy which one can hope to attain will, of course, differ in the case of different instruments and apparatus, for all are not capable of the same degree of accuracy; it is necessary, therefore, to ascertain what is the degree of accuracy of each instrument or piece of apparatus. Since the apparatus for the determination of weight (or mass) and of volume are those most generally concerned, either directly or indirectly, in chemical or physico-chemical measurements, we shall first consider the methods of calibrating them. The methods of calibrating other measuring instruments will be described as occasion arises.

THE BALANCE

The determination of the mass or weight¹ of a body is one of the most fundamental of physical measurements, and it is

¹ The weight of a body is proportional to the mass, being equal to the mass multiplied by the force of gravity. While the mass remains constant, the weight will vary with the place.

also one which is capable of a very high degree of accuracy. With a balance such as is employed in chemical analysis, it is not a matter of great difficulty to determine the weight of a body, weighing say about 100 gm., with an accuracy of one part in one hundred thousand. Indeed, the accuracy of the balance is in many cases greater than the accuracy with which a body can be defined or reproduced. Thus, in weighing vessels or apparatus of glass or other material before and after they have been used in an experiment, the difference in weight, due to the handling, the manner of drying the apparatus, etc., may sometimes amount to at least several tenths of a milligram, while the accuracy of the balance itself might quite well allow of the weight being determined to less than one-tenth of a milligram.

After a balance has been placed in position and levelled, it should be tested with regard to its adjustment and its sensitiveness.

The first requirement which a balance must satisfy is that it shall be consistent with itself; *i.e.* successive determinations of the weight of an object must be in agreement. From the closeness of agreement between the different weighings, the accuracy of the balance can be judged.

Determination of the Zero Point.—Before using the balance, and also from time to time during a set of weighings, the zero point, or the position of rest of the beam when unloaded, should be determined. This is done by releasing the beam and allowing it to swing free. Readings are then taken of the extreme points on the scale reached by the pointer on either side of the middle line; two readings being made on one side of the middle line, and one on the other, the first swing being neglected. Suppose that the turning points on the right of the middle line were 6.0 and 5.5, while the turning point on the other side was 5.7; then the turning point on the right corresponding with the point 5.7 on the

left is $\frac{6.0 + 5.5}{2} = 5.8$. The corresponding turning points are therefore equidistant from the middle line, and the zero point is therefore correct.

On the other hand, suppose that the following turning points were observed, the readings to the right being called positive and those to the left negative—

$$\begin{array}{r} -4.5 \\ +6.0 \\ +5.5 \end{array}$$

then the turning point on the right corresponding with that on the left is $\frac{+6.0 + 5.5}{2} = +5.8$, and the resting point is therefore $\frac{+5.8 - 4.5}{2} = +0.7$; *i.e.* the zero is 0.7 division to the *right*. Or again, suppose the turning points to be—

$$\begin{array}{r} -6.5 \\ +5.0 \\ +4.6 \end{array}$$

then the corresponding turning points are -6.5 and $+4.8$, and the zero is therefore $\frac{+4.8 - 6.5}{2} = -0.9$; *i.e.* 0.9 of a division to the *left* of the middle line.

Rule.—To find the position of rest, take the mean of the two readings on the one side, and divide the *algebraic* sum of this mean and the reading on the opposite side of the middle line by 2; the result gives the scale division corresponding with the resting point, and the sign (+ or -) indicates on which side of the middle line the zero lies.

Two or three determinations of the zero point should be made, and the mean taken. With a good balance the different determinations should not differ by more than one or two tenths of a scale division.

Unless the zero point is considerably removed from the middle line, the adjustment of the balance need not be altered;

but if it should be in excess of one scale division, the zero point should be corrected by means of the small screws at the ends of the beam, or of the metal flag which is above the centre of the beam.

Sensitiveness of a Balance—Weighing by Oscillations.—In determining the weight of a body, weights to the nearest centigram are placed on the scale-pan of the balance, and the milligrams and fractions of a milligram then determined by means of the rider. The fractions of a milligram can, however, be determined more accurately by the method of oscillations. As this depends on the sensitiveness of the balance, the latter must first be determined.

By the *sensitiveness* of a balance is meant the displacement of the resting point of the beam produced by an excess of 1 mgm. on either side of the balance. The sensitiveness varies with the load on the balance, although, as a rule, not to any great extent, and should be determined, therefore, with different weights in the scale-pans. To obtain the sensitiveness of a balance, place on one side of the balance a given weight, and counterpoise it to within 1 mgm. by means of weights and rider. Determine the resting point by the method given above. Now alter the position of the rider by an amount corresponding to 1 or 2 mgm., in such a direction that the resting point is now on the other side of the zero point. The sensitiveness is then given by dividing the number of scale divisions between the two resting points by the difference of weight in milligrams.

EXAMPLE.—Suppose that with the weight 10.354 gm. the resting point is found to be + 1.2; and with the weight 10.355 gm. the resting point is - 0.8. Then, the displacement of the resting point by a difference of weight of 1 mgm. is 2.0 scale divisions; and the sensitiveness is therefore 2.0 scale divisions for a load of 10 gm.

The sensitiveness can be increased or diminished by raising

or lowering the centre of gravity of the swinging parts of the balance by means of the so-called gravity bob, with which the better balances are furnished. Increase of sensitiveness, however, entails increase in the time of swing, and should not be carried too far.

Having determined the sensitiveness of a balance at a number of different loads in the above manner, the operation of weighing can be shortened, because it is only necessary to adjust the weight to the nearest milligram, and to determine the resting point, provided the zero point has been previously determined. The fractions of a milligram can then be calculated from the difference between the resting point with a given weight and the zero point, and the sensitiveness of the balance.

EXAMPLE.—Suppose that the zero point of the balance is $+0.5$, the resting point with the weight 10.354 gm., $+1.2$, and the sensitiveness 2.0 scale divisions. Then the additional weight required is $\frac{1.2 - 0.5}{2} = 0.35$ mgm. The correct weight is therefore 10.35435 gm.

We have here given the weight to five places of decimals, but whether or not the last place has any meaning, will depend on whether the weight of the object which is being weighed remains constant to within one or two hundredths of a milligram. If it may vary by some tenths of a milligram, it will evidently be absurd to state the weight to five places of decimals. To weigh correctly to one or two units in the fifth decimal place demands experience and great care, so that in ordinary work a greater accuracy than one or two units in the fourth place of decimals cannot be expected.

As in all our work we shall be concerned only with differences in weight, a slight inequality in the length of the arms of the beam will have no influence, provided the object to be weighed is always placed on the same side of the balance. This, of course, should be made a rule.

It should be unnecessary to emphasize here that accurate weighings can be expected only if the balance is kept clean and free from dust, and if the beam is released and arrested in such a manner as not to cause jarring of the knife-edges. The beam must never be released with a jerk, and should be arrested only when the pointer is passing the middle point of the scale. The balance, also, should not be exposed to unequal heating, and should not, therefore, be placed in a window exposed to direct sunlight.

Calibration of Weights.—Even after the adjustment and accuracy of the balance has been tested in the manner described above, the accuracy of the weighings will still depend on the accuracy of the weights employed. Before undertaking accurate weighings, therefore, it is necessary to determine the errors in the weights; and even in cases where great accuracy is not aimed at, a set of weights should always be calibrated, for errors of quite appreciable magnitude are sometimes found, even in expensive sets.

The method usually employed for the calibration of weights is that due to Kohlrausch, which is described below; and we shall assume that the set of weights consists of the following pieces—50, 20, 10', 10'', 5, 2, 1', 1'', 1''' gm. weights, and corresponding fractional parts.

Having determined the zero of the balance, the 50-gm. weight is compared with the sum of the others. In order to determine the ratio of the balance arms, the method of double weighings is employed; and the resting point is always determined by the method of oscillations.

Place the 50-gm. weight on, say, the left scale-pan, and the weights from 20 gm. downwards on the right, and determine what weight, if any, must be added to the weights on the right or left in order to give exact counterpoise, *i.e.* in order that the resting point coincides with the zero point of the balance. Now interchange the weights, placing the 50-gm. weight on the right

and the other weights on the left, and determine what weight must now be added to the left or right, in order to obtain exact counterpoise. In this way we obtain the two equations—

$$50 = 20 + 10' + 10'' + 5 + 2 + 1' + 1'' + 1''' + r \text{ gm.}$$

$$20 + 10' + 10'' + \dots + l \text{ gm.} = 50$$

From these two weighings we obtain—

$$50 = 20 + 10' + 10'' + \dots + \frac{1}{2}(r + l)$$

If, however, we know the ratio of the balance arms,¹ $\frac{R}{L}$, then only one weighing is necessary, because, from the theory of levers, a weight w placed on the right pan is equivalent to a weight $w \times \frac{R}{L}$ on the left. Thus, suppose we have found the ratio $\frac{R}{L} = 1.000009$, and suppose we have also obtained the weighing—

$$50 \text{ gm. (standard)} = 50 + 0.0001$$

then we obtain—

$$50 \text{ gm.} - 0.0001 = 50 \times 1.000009 = 50 + 0.00045$$

Therefore the true value of the 50-gm. weight is—

$$50 \text{ (standard)} - 0.00055 = 49.9995 \text{ gm.}$$

As the value of the ratio $\frac{R}{L}$ varies slightly with the load, it should be determined with different loads—say with 50 gm. and with 20 gm. on each scale-pan. The value found in the second case can then be used for the smaller weights, for in general the correction is so small as to be negligible.

One proceeds, in the manner described above, with the comparison of the other weights among themselves, comparing

¹ The ratio of the balance arms is given by the expression $\frac{R}{L} = 1 + \frac{l-r}{100}$, where l and r have the meaning given above.

the 20-gm. weight with the sum of $10' + 10''$, $10'$ with $10''$, 10 with the sum of $5 + 2 + 1' + 1'' + 1'''$, 2 with $1' + 1''$, $1'$ with $1''$ and with $1'''$. Similarly with the fractions of a gram. In this way the relative values of the different weights are obtained, and if we know the exact value of any one of the pieces (by comparison with a standard weight), we can calculate the correct values of the other pieces; or we can assume some one of the weights to be correct, and reduce the values of the others to that unit. This method is sufficient where we are dealing only with relative weighings.

The following example will make the method quite clear. The weighings should be made to the fifth place of decimals by the method of oscillations. In the example below, the numbers have been rounded off to the nearest tenth of a milligram.

EXAMPLE:—

$$\begin{aligned}
 1. \quad 50 \text{ gm. (standard)} &= 50 + 0.0001 \\
 50 + 0.0010 &= 50 \text{ gm. (standard)} \\
 \text{hence } 50 \text{ gm. (standard)} &= 50 + \frac{1}{2}(0.0010 + 0.0001) \\
 &= 50 + 0.0005
 \end{aligned}$$

$$\text{Therefore } 50 = \underline{49.9995} \text{ gm.}$$

$$\text{Also, } \frac{R}{L} = 1.000009$$

$$\begin{aligned}
 2. \quad 50 + 0.0057 &= 20 + 10' + 10'' + \text{etc.} \\
 20 + 10' + 10'' + \dots &= 50 + 0.0049 \\
 \text{hence } 50 &= 20 + 10' + 10'' + \dots - 0.0053
 \end{aligned}$$

$$\text{and } \frac{R}{L} = 1.000008$$

$$\begin{aligned}
 3. \quad 20 &= 10' + 10'' + 0.0017 \\
 10' + 10'' + 0.0018 &= 20 \\
 \text{hence } 20 &= 10' + 10'' + 0.0018
 \end{aligned}$$

$$\text{and } \frac{R}{L} = 1.000001$$

$$4 \quad 10' = 10'' + 0.0002, \quad \frac{R}{L} = 1.000001$$

$$\therefore 10' = 10'' + 0.0002$$

$$5. \quad 10' + 0.0022 = 5 + 2 + 1' + 1'' + 1''' \left(\text{Neglect } \frac{R}{L} \right)$$

$$\therefore 10' = 5 + 2 + 1' + 1'' + 1''' - 0.0022$$

$$6. \quad 5 = 2 + 1' + 1'' + 1''' - 0.0026$$

and so on.

By comparison with the standard weight we found that the piece marked 50 has the mass 49.9995 gm.

From weighing (2), we therefore obtain—

$$49.9995 \text{ gm.} = 20 + 10' + 10'' + \dots - 0.0053$$

$$\text{or, } 20 + 10' + 10'' + \dots = 50.0048 \text{ gm.}$$

But from the relationships found above, we can write—

$$20 + 10' + (10' - 0.0002) + (10' + 0.0022) = 50.0048 \text{ gm.}$$

$$\text{or } 20 + 10' + 10' + 10' = 50.0028 \text{ gm.}$$

$$\text{Further, } 20 = 10' + 10'' + 0.0018$$

$$= 10' + (10' - 0.0002) + 0.0018$$

$$= 10' + 10' + 0.0016$$

$$\text{Hence } (10' + 10' + 0.0016) + 10' + 10' + 10' = 50.0028 \text{ gm.}$$

$$\text{or } 5 \times 10' = 50.0012 \text{ gm.}$$

$$\text{therefore } 10' = 10.0002 \text{ gm.}$$

$$\text{and } 10'' = 10.0000 \text{ gm.}$$

$$20 = 20.0020 \text{ gm.}$$

and similarly with the lower weights.

Correction for the Buoyancy of the Air.—In exact determinations of the weight of a body, the apparent weight, *i.e.* the sum of the face values of the weights used (corrected as

described above) must be corrected for the buoyancy of the air; for a body will appear lighter by an amount equal to the weight of the air displaced. The greater the difference in the density or the specific volume of the body and the weights used to counterpoise it, the greater will be the correction.

If we have a body of the density d counterpoised by brass weights of the value G gm., the volume of the body will be $\frac{G}{d}$ c.c., and its weight will therefore be diminished by $\frac{0.0012G}{d}$ gm., where 0.0012 gm. is the weight of 1 c.c. of air under ordinary conditions (mean room temperature, normal pressure, and average humidity). The true weight of the body would therefore be $\left(G + \frac{0.0012G}{d}\right)$ gm., if the true weight of the counterpoise were G gm. But the brass weights by which the body is counterpoised have a volume equal to $\frac{G}{8.5}$ c.c., where 8.5 is the density of brass; and they therefore suffer a diminution in weight of $\frac{0.0012G}{8.5}$ gm. The true weight, G_0 , of the body is therefore equal to $G + \frac{0.0012G}{d} - \frac{0.0012G}{8.5}$, or

$$G_0 = G\left(1 + \frac{0.0012}{d} - \frac{0.0012}{8.5}\right) = G\left(1 + \frac{0.0012}{d} - 0.00014\right)$$

In order, therefore, to obtain the true weight (*i.e.* the weight which the body would have in a vacuum) of a body weighed in air with brass weights, we must *add to each gram apparent weight* (G) the quantity $\left(\frac{0.0012}{d} - 0.00014\right)$ gm. The following table given by Kohlrausch gives the value of this correction in milligrams for different values of d :—

d	Correction.	d	Correction.	d	Correction.
0·7	+ 1·57	2·0	+ 0·457	9	- 0·010
0·8	+ 1·36	2·5	+ 0·337	10	- 0·023
0·9	+ 1·19.	3·0	+ 0·257	11	- 0·034
1·0	+ 1·06	3·5	+ 0·200	12	0·043
1·1	+ 0·95	4·0	+ 0·157	13	- 0·051
1·2	+ 0·86	4·5	+ 0·124	14	- 0·057
1·3	+ 0·78	5·0	+ 0·097	15	- 0·063
1·4	+ 0·71	5·5	+ 0·075	16	- 0·068
1·5	+ 0·66	6·0	+ 0·057	17	- 0·072
1·6	+ 0·61	6·5	+ 0·042	18	- 0·076
1·7	+ 0·56	7·0	+ 0·029	19	- 0·080
1·8	+ 0·52	7·5	+ 0·017	20	- 0·083
1·9	+ 0·49	8·0	+ 0·007	21	- 0·086

CALIBRATION OF VOLUMETRIC APPARATUS

For volumetric work flasks, pipettes, and burettes are employed, which are constructed and marked so as to take up or deliver a definite volume of liquid. The apparatus were formerly graduated according to the method of Mohr, who took as the unit the volume of 1 gm. of water at 17·5° when weighed in air with brass weights. Evidently, this volume will differ from the true cubic centimetre (*i.e.* the volume of 1 gm. of water at 4°, the weight being reduced to vacuum), owing to the neglect of the buoyancy of the air, and the change of volume with the temperature; and is, indeed, 2·4 parts per thousand greater than the volume in true cubic centimetres.

In volumetric analysis this method of graduation gives rise, of course, to no error, because the volume measurements with the different apparatus are only relative. It is, therefore, of no consequence what volume is taken as the unit, provided the same unit is employed throughout for the different apparatus.

The case is, however, very different when the volumetric apparatus is to be used for the purpose of preparing solutions of definite concentration, or for other purposes where the

different apparatus are used independently; in this case the apparatus must be graduated in true cubic centimetres.

In order to determine a given volume, one determines the weight of a liquid, generally water (distilled), required to fill the volume, the weight being reduced to vacuum. To save the trouble of making this reduction, use can be made of the following table, which gives the volume (in true cubic centimetres) corresponding to an apparent weight of 1 gm. of water (*i.e.* weight in air); and the apparent weight of 1 c.c. of water, at different temperatures. The table applies only when the weighings are carried out with brass weights.

Temperature.	Apparent weight of 1 c.c. of water.	Volume corresponding with an apparent weight of 1 gm. of water.
10°	0.9986	1.0014
11°	0.9985	1.0015
12°	0.9984	1.0016
13°	0.9983	1.0017
14°	0.9982	1.0018
15°	0.9981	1.0019
16°	0.9979	1.0021
17°	0.9977	1.0023
18°	0.9976	1.0024
19°	0.9974	1.0026
20°	0.9972	1.0028
21°	0.9970	1.0030
22°	0.9967	1.0033
23°	0.9965	1.0035
24°	0.9963	1.0037
25°	0.9960	1.0040

Calibration of Measuring Flasks.—For the purpose of measuring definite volumes of liquid, as, for example, in making solutions of definite concentration, flasks of various sizes, provided with fairly long necks are employed. These should be fitted with accurately fitting, ground-in stoppers (hollow stoppers being preferable to those of solid glass), and are made so as to contain a definite, whole number of cubic centimetres of a

liquid when filled up to a ring marked on the neck. The bulb of the flask should be of such a size that the volume mark is near the lower end of the neck.

With regard to the width of the neck, this should be of such a size that the error in reading the volume is not greater than the allowable error in the calibration of volumetric apparatus, which may be taken as 0.05 per cent. of the volume measured. In the case of smaller flasks, for 50 c.c. or less, the Regnault flask (Regnault pycnometer) is very useful. This has a very narrow neck, so as to diminish the error in reading; and in order to obtain sufficient air-space to ensure ready mixing, the neck is widened at the top (Fig. 1).

Although the flasks made by the best makers will, as a rule, be found sufficiently accurate, no flask should be employed for accurate work without being tested.

To calibrate a flask, the latter is first cleaned and thoroughly dried; it is then counterpoised on a balance, and distilled water, having a temperature of 15° to 18° , is run into the flask until the lower edge of the meniscus stands at the level of the volume mark on the neck. Any water which may have got on the neck above the mark should be removed by means of filter paper. The weight of the water is then determined. (For flasks having a volume of 200 c.c. upwards, the weighings should be carried out on a balance, which need not be accurate to less than a centigram; in the case of smaller flasks, the weighing must be done on a more sensitive balance.)

Having determined the weight of water contained in the flask up to the mark, the volume can be obtained from the table given above. For example, since an apparent weight of 1000 gm. corresponds with a volume at 17° of 1002.3 c.c., the true volume of the flask is obtained from the expression

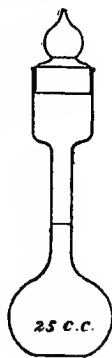

FIG. 1.

$\frac{1002.3 \times w}{1000}$, where w is equal to the weights employed. If the error is at all considerable, a second ring, corresponding with the volume of 1000 c.c. (or other volume, according to the flask), should be etched on the neck.

It may also be necessary sometimes to graduate a flask for one's self. In this case the flask, after being cleaned and dried, is counterpoised on a suitable balance; the necessary weights are placed on the scale-pan, and distilled water is then poured into the flask until equipoise is obtained. In this case the last few cubic centimetres should be introduced by means of a pipette, any drops of water which may have formed on the upper part of the neck being first removed by filter paper. Since from the table we learn that the apparent weight of 1 c.c. of water at 17° is 0.9977 gm., the weights necessary for any given volume can be calculated.

Marking a Ring on the Neck.—After the necessary amount of water has been introduced into the flask, the latter is placed on a level table, and a strip of gummed paper is then fixed round the neck, so that its upper edge coincides with the lower edge of the water meniscus. The water is then emptied from the flask, and the neck coated with a thin, uniform layer of paraffin wax, extending some distance on either side of the gummed paper. When the wax has become cold, a ring is cut by means of a knife along the upper edge of the gummed paper. The exposed glass is then etched by means of hydrofluoric acid, the acid being rubbed into the cut in the wax by a little mop of cotton-wool wound round the end of a stout copper wire.

Calibration of Pipettes.—Pipettes are calibrated by weighing the water which they deliver. In carrying out the calibration, however, several precautions must be observed if an accuracy of 0.05 per cent. is to be obtained. In the first place, it must be seen that the glass of the pipette is free from

all greasiness, so that the water runs from the pipette without leaving drops behind. If necessary, therefore, the pipette must first be thoroughly cleaned. This is best effected by filling the pipette several times with warm concentrated sulphuric acid, to which a quantity of a solution of potassium bichromate has been added, or the pipette may be left for some time full of the acid bichromate mixture.¹ If the liquid is sucked up by mouth, care must be taken not to suck the solution into the mouth. As this sometimes happens, owing to the end of the pipette being inadvertently raised above the level of the solution, it is wise to attach to the end of the pipette a safety tube of the form shown in the figure (Fig. 2).

Again, attention must be paid to the way in which the pipette is allowed to deliver, and also to the time of delivery. In allowing a pipette to deliver, place the end against the side of the vessel into which the liquid is being run, and immediately the liquid ceases to flow, blow through the pipette and then withdraw. The pipette, also, must not be allowed to deliver too rapidly, otherwise varying amounts of liquid will be left adhering to the sides, and, consequently, the volume delivered will vary. The time of outflow must therefore be regulated so that the time required for delivery is from 40 to 50 seconds. This can be effected by partially closing the end of the pipette in the Bunsen flame.

Having cleaned and regulated the time of outflow of the pipette, the position of the mark on the stem is first determined approximately. To do this, a mark is made on the stem with a pencil for writing on glass, or with ink; distilled water is drawn up



FIG. 2.

¹ When not in use, pipettes should be kept standing in a tall cylinder full of the bichromate solution, or be laid, filled with the bichromate solution, in a horizontal position; the glass will in this way be prevented from becoming greasy. The pipette is then rinsed out two or three times with distilled water before use.

to this mark, and then allowed to flow into a previously weighed stoppered or corked flask, and the weight of water determined. According as this weight is greater or less than the desired amount, a strip of gummed paper, with sharp cut edge, is placed round the stem of the pipette below or above the first mark; water is sucked up into the pipette, its level adjusted to the upper edge of the paper strip, and the weight of water delivered determined. If the correct position has not yet been obtained, another strip of paper is fixed round the stem, and another weighing of the water delivered is made. Some idea of where this second strip must be placed will be obtained from the difference between the first two weighings and the distance of the two marks apart. The second strip should be fixed at such a point that the weight of water is on the opposite side of the correct weight from that given by the first strip; *i.e.* if the former weight was too small, the second strip should be placed so as to give too great a weight. Having in this way determined two points on the stem of the pipette, such that the weight of water delivered is too great in the one case and too small in the other, the correct position of the mark can be calculated fairly approximately from the difference of the two weighings and the distance of the paper strips apart. A third paper strip should then be placed at the calculated point, and the correctness of the position tested by weighing the water delivered. Three concordant weights, the mean of which does not differ from the correct weight by more than 0.05 per cent., must be obtained. To obtain the correct weight, we again make use of the table on p. 30, in order to find the apparent weight corresponding with the volume desired. The temperature of the water used should be that of the mean room temperature, 15° to 18°.

The position of the mark on the stem having been determined, a ring is etched as explained on p. 32.¹

¹ The calibration as carried out above is valid only for water and

For certain purposes (*vide* Chap. IX.) pipettes are required to *take up* a definite volume of liquid. To calibrate a pipette for this purpose, a stoppered flask containing distilled water is weighed; water is then drawn up to a mark on the pipette, and the amount thus withdrawn determined by reweighing the flask and water. The correct position of the mark on the pipette is determined by trial in the manner described above, and the correctness of the position tested by repeating the operation several times, as in the previous method of calibration. In order that the amount of water adhering to the walls of the pipette shall be as nearly as possible the same each time, the pipette should be placed in an upright position, with the point resting on filter paper, and allowed to drain for about five minutes.

Calibration of Burettes.—Burettes are most simply calibrated by the Ostwald method with the help of a small pipette (generally 2 c.c.), the volume of which has been accurately determined (Fig. 3). The calibration pipette is attached to the burette in the manner shown in the figure (Fig. 4). If the burette is furnished with a glass tap, the clip I is omitted. The pipette may be kept in position by means of a loop of copper wire passing round the burette and the upper end of the stem of the pipette.

Before use, the burette

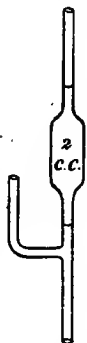

FIG. 3.

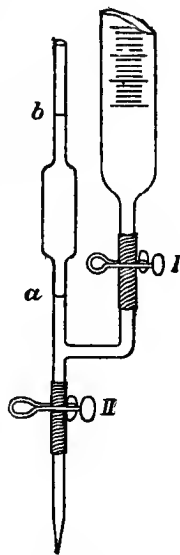

FIG. 4.

aqueous solutions. Where the pipette is to be used for other liquids, a re-determination of the volume of liquid delivered should be made by dividing the weight delivered by the density of the liquid at the particular temperature.

and the pipette must first be thoroughly cleaned with bichromate and sulphuric acid (p. 33). The pipette is then attached to the burette, and the latter filled full with water. The clip I (or the stop-cock of the burette) is then opened so as to fill the side tube of the pipette and the lower part of the latter below the mark a , care being taken that all air-bubbles are driven out of the tubes. The level of the water is then adjusted so that it stands at the zero mark on the burette, and at the mark a on the calibration pipette. The clip I is then carefully opened, and water allowed to flow from the burette until it reaches the mark b on the pipette. We have thus withdrawn a definite volume (say 2 c.c.) from the burette, and the reading on the burette is compared with this. The clip II is then opened, and water allowed to run from the pipette until it reaches the mark a , and is collected in a small flask which has been previously weighed. The flask should be kept corked except while water is being run into it. A further 2 c.c. of water is allowed to run from the burette, and a reading again made; clip II is again opened, and water allowed to run from the pipette until the level falls to a ; the water being again collected in the weighed flask. These operations are repeated until the water has been run down to the lowest mark on the burette. The total weight of water thus run off is determined, and from this the volume of the calibration pipette is obtained. Knowing the volume of the pipette, and the corresponding readings on the burette, the corrections for the latter are obtained. Thus, suppose that the volume of the pipette was found correct, equal to 2 c.c., and that the readings on the burette, after successive withdrawals of 2 c.c., were 1.99, 3.96, 5.98, 8.02, 10.02, 11.98, etc., then the corrections to be applied at the points 2, 4, 6, 8, 10, 12, etc., c.c. on the burette would be +0.01, +0.04, +0.02, -0.02, -0.02, +0.02, etc., and at any intermediate point, the correction may be taken as proportional to the corrections on either side of it. These

corrections for every two 2 c.c. may be written in tabular form; but it is better, especially if the corrections are considerable, to draw a curve of corrections, the burette readings being represented as abscissæ, and the value of the corrections being represented as ordinates above (for positive corrections) or below (for negative corrections) the abscissa axis. The correction values are then joined by straight lines, so that for any given reading on the burette

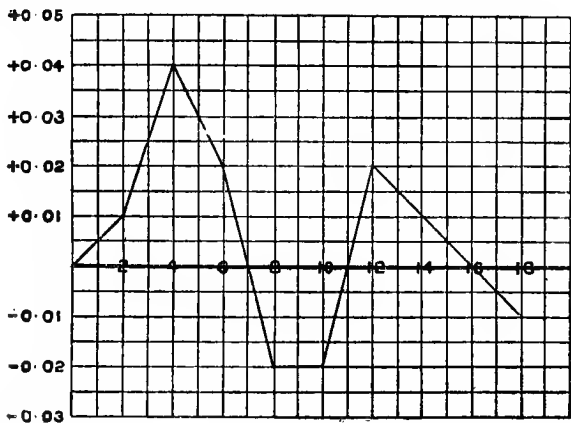

FIG. 5.

the correction can be seen at a glance. Such a curve of corrections, plotted from the figures given above, is shown in the diagram (Fig. 5).

As with pipettes, so also in the case of burettes, attention must be paid to the rate at which the liquid is allowed to flow out. The minimum time of outflow advisable will depend on the volume of liquid delivered; for 30 c.c. it should be not less than about 40 seconds.

With burettes the accuracy to be attained is not in general

so great as with pipettes, and will depend on the width of the burette. The latter should be as small as possible, consistent with convenience in length. For most purposes it is convenient to use a 30-c.c. burette, the width of which should be from 8-10 mm. With such burettes an accuracy of about 0.1 per cent. can be obtained on a reading of 10 c.c.

Parallax.—In making a reading of volume by means of a burette, it will be found that as the line of vision is raised or lowered, the apparent position of the liquid meniscus alters. Owing to this apparent change of position, to which the term *parallax* is applied, such volume readings are liable to considerable errors. These can be avoided most easily by placing a piece of mirror glass behind the burette, and then raising or lowering the line of vision until the meniscus and its image just coincide. The eye is then on the same level as the meniscus, and the error due to parallax disappears. The reading is then made with the eye in this position.

Errors due to parallax can also be avoided by means of the Shellbach stripe, and the use of the now well-known Shellbach burette is consequently to be strongly recommended.

It will be clear that the precautions to be taken in reading a burette should also be taken when using apparatus of a similar character, *e.g.* the barometer, eudiometer, mercury manometer, etc.

References.—For a second method of calibrating weights, see Richards, *J. Amer. Chem. Soc.*, 1900, 22, 144; *Zeitschr. physikal. Chem.*, 1900, 33, 605.

For a discussion of the accuracy of pipettes and burettes, see Wagner, *Zeitschr. physikal. Chem.*, 1899, 28, 193.

CHAPTER III

DENSITY OF LIQUIDS AND GASES

A.—DENSITY OF LIQUIDS

THE density (absolute) of a liquid or solid is the mass of unit volume of the substance. Generally, however, in using the term "density" at a given temperature, one really means the *relative* density, or the density at a given temperature relatively to the density of a standard substance (water) either at the same temperature (represented by $d_t^{t^\circ}$) or, more frequently, at 4° (represented by $d_4^{t^\circ}$). When, in the latter case, the density is corrected for the buoyancy of the air (see p. 27), the number obtained represents the *specific gravity* of the substance. It is the property which should be used in characterising a liquid or solid substance.

The density of liquids is most easily determined by means of vessels of accurately defined volume, called *pyknometers*. These are made of very varying shapes, but the simplest and most generally useful form is the Ostwald modification of the Sprengel pyknometer (Fig. 6).

This form of pyknometer, which can be easily made by the student, consists of a moderately wide (10–15 mm.) and rather thin glass tube, to which narrower tubes, *a* and *b*, are sealed and bent as shown in the figure. These are preferably made of light capillary

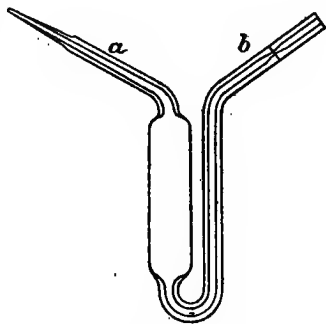

FIG. 6.

tubing, with not too thick walls, and with a lumen of about 1-1.5 mm in diameter. About the middle of the upper arm of the tube *b*, the bore of the tube should be slightly constricted, and a ring etched on the glass; and tube *a* should be drawn out to a point, and the bore thereby constricted. If desired, the ends *a* and *b* may be fitted with caps, which may be ground so as to fit accurately, or which may simply be slipped over the ends of *a* and *b*. In general, however, these will not be absolutely necessary.

The volume of the pyknometer should be about 5-15 c.c. This will allow of an accuracy of about 1 unit in the fourth place of decimals, which will be quite sufficient for all our purposes.

In carrying out a determination of the density of a liquid, the pyknometer must first of all be cleaned and dried, by washing well with distilled water (if necessary, with other solvents first, and then with water), and then with a small quantity of alcohol (redistilled methylated spirit). It is then placed in a steam oven for 10-15 minutes, and a current of air drawn through by means of a pump. It should, however, be noted that after being heated, the pyknometer does not immediately acquire its true volume on cooling; and an appreciable error may be introduced, especially in more accurate work, if sufficient time (from 12 hours up to several days, according to the glass of which the pyknometer is made) is not allowed to elapse before the pyknometer is used. If it is not convenient to wait this time, the heating should be avoided, and the pyknometer cleaned and dried by washing successively with water, alcohol, and ether (redistilled), and then drawing a current of air through the tube.

The pyknometer, cleaned and dried, is first weighed empty. For this purpose it is suspended from the end of the balance beam by means of a double hook (Fig. 7), made either from platinum or from copper wire, preferably the

former.¹ The pycnometer is then filled with distilled water, which has been recently boiled and allowed to cool, by attaching a piece of india-rubber tubing to the end *b*, and sucking gently while the end *a* dips in the water. The introduction of air-bubbles must be carefully avoided. The pycnometer thus filled is then suspended in a large beaker of water, the temperature of which must be kept constant to within 0.1° , as shown by a thermometer immersed in the water. Where a number of determinations of the density have to be made, it is more convenient to use a constant temperature bath (thermostat), the temperature of which is maintained constant by means of an automatic thermo-regulator (see p. 63).



FIG. 7.

The pycnometer may be suspended in the bath by means of a wire hook placed over a glass rod laid across the top of the beaker; but it is better to use a holder cut from sheet zinc or copper (Fig. 8), and furnished with lugs which can be hooked over the edge of the bath. In the sheet of metal a hole is cut, which allows the body of the pycnometer to pass through, while the arms rest against the ends *a* and *b*.

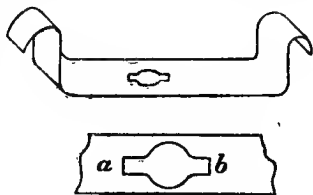

FIG. 8.

The length of the opening should be such as to allow the pycnometer to pass so far through, that the mark on the tube *b* of the pycnometer is just above the metal plate; and the water in the bath should be of such a height that it just touches the under side of the plate. By means of this arrangement, the danger of water getting

¹ It is not advisable to attach a wire permanently to the pycnometer, because of the greater difficulty in removing all moisture after the pycnometer has been immersed in water.

into the ends of the pyknometer tubes is avoided, and the pyknometer is held in position more securely than by hooks.

When the pyknometer and its contents have taken the temperature of the bath (say after 15–20 minutes), the amount of water must be so adjusted that it fills the pyknometer from the point of the tube *a* to the mark on *b* (Fig. 6). If there is too little water, a rod or tube carrying a drop of water is placed against the end of the tube *a*, when water will be drawn into the pyknometer by capillarity. If there is too much water, a piece of filter paper is carefully placed against the end of *a*, whereby water can be drawn from the pyknometer until the meniscus stands opposite the mark on *b*. This requires a little care. If too much water is withdrawn, more must be introduced as described above, and the adjustment again made by means of filter paper.

Instead of using filter paper, the adjustment can also be made in the following manner: A piece of rubber tubing, a few centimetres in length, is placed over the end of *b*, and a rough adjustment made by pushing a glass rod into the open end of the rubber tube. The exact adjustment is then made by compressing the rubber tube with the fingers until the water is driven along to the mark. Before releasing the tube, any drop of water which may have collected at the point of *a* is removed by means of a glass rod. The pyknometer is now removed from the bath, and the outside carefully dried by means of a cloth, whereby care must be taken that none of the water is expelled from the pyknometer by the heat of the hand.¹ When it has taken the temperature of the balance case, it is weighed.

If concordant and accurate weighings are to be obtained, it is essential that the outside of the pyknometer shall always be dried and treated in exactly the same way, since otherwise the amount of moisture which remains adsorbed on the surface will vary, and may cause an appreciable error.

¹ This danger is avoided to a very great extent if a small bulb is blown on the arm of the pyknometer to the right of the mark *b* (Fig. 6).

After having determined the weight of the pyknometer filled with water, the pyknometer is once more dried out and filled with the liquid the density of which is to be determined. It is placed as before in the bath at constant temperature, the liquid is adjusted to the mark, the pyknometer dried with a cloth in the same manner as before, and weighed.

Calculation of the Density.—If the temperature at which the pyknometer is filled with water and with the other liquid is the same, then the ratio of the weight of liquid (W') to the weight of the water (W) gives the approximate density (uncorrected for the buoyancy of the air) of the liquid compared with that of water at the same temperature. This is

represented by $d_t' = \frac{W'}{W}$. For certain purposes, as in the deter-

mination of the relative viscosity (Chap. V.), this ratio is all that is required; but in all cases where the specific gravity of the liquid is desired, we must compare the weight of the liquid at the temperature t° with the weight of the same volume of water at 4° . The density of the liquid at temperature t° compared with water at 4° is then given by the expression

$d_{4^\circ}^{t^\circ} = \frac{W'}{W} \times D$, where D is the density of water at t° . (See

Table below.)

The value of the density just given must still be corrected for the buoyancy of the air by taking into account the density of the latter, and we therefore obtain as the expression for the specific gravity of a liquid—

$$d_{4^\circ}^{t^\circ} = \frac{W'D}{W} - \frac{0.0012(W' - W)}{W}$$

If the temperature at which the pyknometer is filled with water and with the other liquid is not the same, a further correction is necessary for the expansion of the glass, and we obtain as the general expression for the specific gravity of a liquid—

$$d_{t'}^{t} = \frac{W'D}{W} - \frac{0.0012(W' - W)}{W} + \frac{W'D}{W} \times 0.000024(t - t')$$

In this expression,

W is the apparent weight of water in air at temperature t ;

W' is the apparent weight of the liquid in air at temperature t' ;

D is the density of water at the temperature t ;

0.000024 is the coefficient of cubical expansion of glass;

0.0012 is the mean density of air.

DENSITY OF WATER AT DIFFERENT TEMPERATURES

Temperature.	Density.	Difference in density for 0.1°, in units of the fifth decimal place.
0°	0.999874	
4°	1.000000	
5°	0.999992	0.8
6°	0.999969	2.3
7°	0.999931	3.8
8°	0.999878	5.3
9°	0.999812	6.6
10°	0.999731	8.1
11°	0.999637	9.4
12°	0.999530	10.7
13°	0.999410	12.0
14°	0.999277	13.3
15°	0.999132	14.5
16°	0.998976	15.6
17°	0.998808	16.8
18°	0.998628	18.0
19°	0.998437	19.1
20°	0.998235	20.2
21°	0.998023	21.2
22°	0.997800	22.3
23°	0.997568	23.2
24°	0.997326	24.2
25°	0.997073	25.3
26°	0.996811	26.2
27°	0.996540	27.1
28°	0.996260	28.0
29°	0.995971	29.0
30°	0.995674	29.7

B.—DENSITY OF GASES AND VAPOURS

Determinations of the density of gases and vapours are of value for the chemist on account of the fact that from the value of the density the molar weight of the substance in the gaseous condition at the temperature of vaporization can be calculated.

As in the case of liquids, the (absolute) density of a gas is the mass of unit volume, *i.e.* of 1 c.c.; but as the volume of a gas is greatly influenced by temperature and pressure, the density of a gas is defined as the mass of 1 c.c. at the temperature of 0° and under the pressure of 760 mm. of mercury. More frequently, however, use is made of the relative density, *i.e.* the weight of a given volume of the gas compared with the weight of the same volume of another gas, the density of which is taken as the unit, when measured under the same conditions of temperature and pressure. As a rule, hydrogen is taken as the comparison gas, its density being put equal to unity. Not infrequently, however, air is employed for the same purpose. Since air is 14.4 times as dense as hydrogen, the density of a gas referred to that of air equal to 1, can be reduced to density relatively to hydrogen by multiplying by 14.4.

If the density of a gas, referred to that of hydrogen equal to unity, is d , then its molar weight is equal to $2 \times d$.

Since, in chemistry, determinations of the density of gases are chiefly made for the purpose of obtaining the molar weight, it has been suggested (Ostwald) to refer the density of a gas to that of oxygen equal to 32. That is to say, as unit of density we choose that of an imaginary gas, the density of which is equal to $\frac{1}{32}$ that of oxygen. In this way the number expressing the density also expresses the molar weight. Since oxygen is now taken as the basis of atomic weights, it is better also to take it as the basis of densities and of molar weights.

Determination of the Density of a Gas.—For the

determination of the density of a gas, the most convenient and at the same time most accurate method is to weigh the gas in

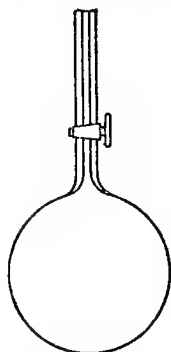

FIG. 9.

a glass bulb of known volume. The bulb, which should be blown strong enough to withstand a pressure of 1 atm., may have a volume of 100–200 c.c.; and sealed into it is a glass tube furnished with a well-fitting glass tap (Fig. 9).¹ Before being used, the tap must be uniformly coated with a lubricant, the best being that recommended by Ramsay.² If it is desired to determine the absolute density of a gas, the volume of the bulb must first be ascertained. This is done by weighing the bulb empty and then filled with distilled water at a known temperature.

To fill the bulb with water, it is first exhausted as completely as possible by means of a pump,³ and the tap then opened while the end of the tube dips under the surface of a quantity of distilled water. The tap is again closed, *so that its bore remains full of water*, and the tube above the tap is then dried by means of filter paper. The bulb full of water is then weighed to 1 cgm. The volume of the bulb is then obtained by dividing the weight of water by its density at the particular temperature (see p. 44).

In order to eliminate as far as possible errors due to the buoyancy of air, a similar globe of approximately the same weight and volume should be used as a counterpoise.

The water is then removed from the bulb by means of a filter pump, and the bulb dried by washing successively with

¹ Chancel flasks are very suitable for this purpose.

² This is made by melting together 3 parts of vaseline, 1 part of paraffin, and 6 parts of soft rubber.

³ A Fleuss pump is the most convenient, but an ordinary water pump may also be used here.

alcohol and ether, warming in a steam oven and exhausting several times till all the ether has been removed.

After a sufficient time has elapsed to allow the bulb to regain its normal volume (see p. 40), it is exhausted by means of a Fleuss or mercury pump and weighed; it is then filled with the gas, the density of which is to be determined, and again weighed. Knowing the volume of the globe and the weight of the gas, knowing also the temperature and pressure at which the globe was filled, the density of the gas or the weight of 1 c.c. at N.T.P. can be calculated.

If W is the weight of the gas filling the globe, the volume of which is v c.c., and if t° is the temperature and p mm. the pressure at which the globe was filled, then the volume of the gas at N.T.P. would be—

$$v_0 = \frac{v \times 273 \times p}{(273 + t) \times 760}$$

The density of the gas is therefore $d = \frac{W}{v_0}$.

Since 1 gm.-molecule of a gas at N.T.P. occupies approximately the volume of 22,400 c.c., the molar weight of the gas is given by $M = \frac{22,400 \times W}{v_0}$.

EXPERIMENT.—*Determine the Absolute Density of Dry Air.*

The volume of the bulb and its weight when exhausted are first determined, as explained above. The dry bulb is then clamped in a bath of water kept at a constant temperature, say 25° (see Chap. IV.), so that the bulb is entirely immersed, but not the stop-cock (Fig. 10), and a T-tube a is attached to it by means of pressure tubing. The side tube of a is connected with a Fleuss or mercury pump by means of pressure tubing on which there is a screw-clip, I; and to the end of a a tube of calcium chloride is attached, also by means of pressure tubing furnished with a screw-clip, II. This clip is kept closed,

and the bulb exhausted by means of the pump; then clip I is closed and II partially opened so that a slow current of air is drawn into the bulb.

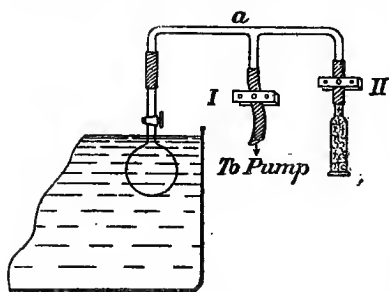

FIG. 10.

The bulb should in this way be twice exhausted and twice filled. It is now allowed to stand in open communication with the air for about five minutes so that the gas may take the temperature of the bath, and the stop-cock is then closed. The tube *a* is

disconnected, and the bulb removed from the bath and carefully dried, bearing in mind what was said with regard to the drying of pycnometers (p. 40). It is then allowed to take the temperature of the balance case and weighed, a similar globe being used as a counterpoise. The barometer must also be read.

The absolute density is then obtained by means of the formula on p. 47.

EXPERIMENT.—*Determine the Density of Carbon Dioxide relative to that of Air, and calculate the Molar Weight of the Gas.*

First weigh the bulb filled with dry air in the manner described in the previous experiment; then fill it with carbon dioxide and weigh again.

For the purpose of filling the bulb with carbon dioxide, an apparatus for generating this gas—best a Kipp apparatus—is attached to the calcium chloride tube, and after the bulb has been exhausted, a slow current of gas is allowed to pass into it, the exhaustion and filling being carried out twice after all the air has been driven from the connecting tubes. The bulb is then left in free communication with the CO_2 apparatus for

about five minutes, the tap then closed, and the bulb disconnected. Since the gas in the bulb is under a pressure greater than atmospheric (owing to the pressure in the generator), it is necessary before removing the bulb from the bath slowly to open and then immediately to close the glass stop-cock, so that the pressure in the bulb becomes equal to the atmospheric pressure. The bulb is then dried as before and weighed.

Since the bulb was filled with air and carbon dioxide at the same temperature and under the same pressure, and since the volume of the two gases is equally affected by changes of temperature and pressure, the ratio of the weights determined above will give the relative density, *i.e.*—

$$\frac{\text{density of CO}_2}{\text{density of air}} = \frac{\text{weight of CO}_2}{\text{weight of air}}$$

The error in the determinations must not exceed 1 per cent.

Calculations—

1. Given that the absolute density of air is 0.001293, calculate from your determinations the absolute density of carbon dioxide.

2. Having given that the density of air referred to that of oxygen equal to 32 is 28.8, calculate the molar weight of carbon dioxide.

Determination of Vapour Density.—For the determination of the density of the vapour of a substance when the latter is not a gas at the ordinary temperature, the method commonly employed is that due to Victor Meyer, or the allied one due to Lumsden.

1. *Victor Meyer's Method.*—The Victor Meyer apparatus (Fig. 11) consists of a cylindrical vessel, B, having a long, narrow neck, to which are sealed two side tubes C and D. The side tube D is closed by a tightly fitting india-rubber stopper, through which a glass rod, with flattened end, passes air-tight. It should be

lubricated with graphite. The side tube C is connected with a bent capillary tube G, the horizontal portion of which may be made from $1\frac{1}{2}$ to 2 feet long; the free end of this tube is

then attached to the top of a Hempel gas burette F, filled with water. In making these connections, thick-walled india-rubber tubing should be employed, and the ends of the two glass tubes should be brought up close together.

The tube B, the upper end of which is closed by a rubber stopper, is placed in the wider tube A, which contains a liquid the boiling-point of which is at least 20° – 30° above the boiling-point of the liquid to be vaporized.¹ The mouth of A is closed by a large cork with a deep groove cut in one side to allow for expansion of the air in the tube. In order to allow B to pass through, it will be necessary to cut the cork in two pieces. To prevent bumping, a few pieces of porous tile, or similar material,

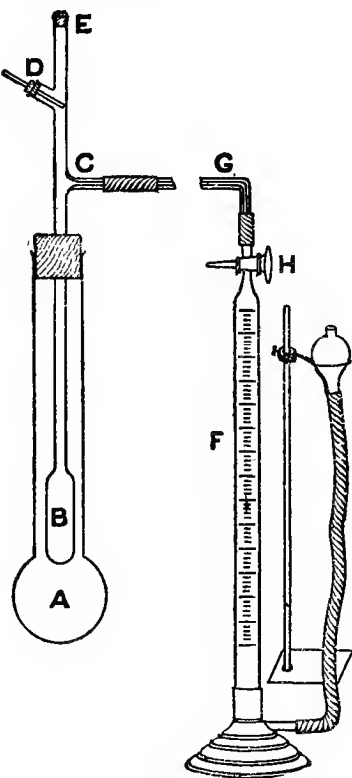

FIG. 11.

are placed in A, and the liquid is boiled, the three-way stopcock H being meanwhile open to the air to allow the expanded

¹ A list of suitable heating liquids is given in the Appendix.

gas to escape. After the liquid in A has been boiling for ten minutes with such vigour that its vapour rises almost to the top of the tube, it is ascertained whether the temperature in B has become constant, by turning the tap H so as to make connection between B and the burette. If the temperature has become constant, the level of the water in the burette will remain unchanged. When constant temperature has been attained, the tap H is again opened to the air, the stopper at the end of B removed, and a weighed quantity of the liquid to be vaporized, contained in a small stoppered weighing bottle, is dropped on the flat end of the glass rod passing through D. The rubber stopper is then replaced, communication between B and the burette made through H, and the bottle with the liquid allowed to drop to the bottom of B by rotating the glass rod. On reaching the bottom of the tube, the liquid is vaporized, and expels a volume of air equal to the volume of the vapour at the particular temperature. As the air passes over into the burette, the reservoir must be lowered so that the level of the water in the reservoir and burette remain about the same. This diminishes the danger of leakage. So soon as the volume of air in the burette becomes constant, the water levels are adjusted and the tap H is closed. The burette is then detached from the rest of the apparatus, and when the temperature has become constant, the water levels are again adjusted and the volume of the expelled air is read off. At the same time the temperature is read from a thermometer hung up beside the burette, and the height of the barometer is also noted.

If a gas burette is not available, an ordinary burette, arranged as shown in Fig. 12, can be employed. The upper end of the burette is closed by a rubber stopper, through which passes a T-tube furnished with a stop-cock, *a*. This takes the place of the three-way tap H of the Hempel burette. To this the tube G from the vaporization bulb is attached. The place of the movable reservoir is taken by the tube A, about 1 cm.

wide, which is attached to the lower end of the burette, and is furnished with a piece of rubber tubing and spring clip B. The burette is filled by pouring water into A, while the tap *a* is open, and the level is adjusted by means of the spring clip

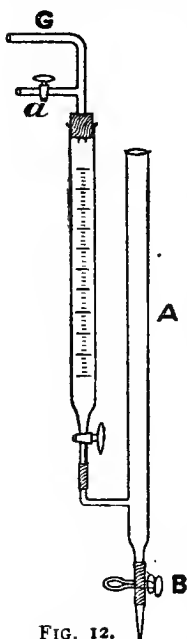

FIG. 12.

B. When the experiment is in progress, and as air is being expelled from the vaporization tube, into the burette, the water must be allowed to run from A so that the level in the two tubes remains about the same. At the end of the experiment the levels are accurately adjusted, and the volume of air in the burette is read off.

It is a further advantage to have the burette surrounded with a mantle through which water circulates. The temperature is then determined by means of a thermometer hung inside the mantle.

Details.—It is desirable that the process of vaporization should take place as rapidly as possible; if it takes place slowly, diffusion and condensation of the vapour on the upper and colder parts of the tube may occur. The volume of air expelled will then be too small. For the same reason, the volume of air expelled should be read as soon as it becomes constant.

It is sometimes found that the stopper of the weighing bottle becomes fixed, so that the liquid is prevented from vaporizing, or vaporizes very slowly. To obviate this, the stopper should be loosened, or removed altogether (if the liquid is not too volatile), before the weighing bottle is dropped on to the glass rod at D. In this case, care must be taken that the weighing bottle is not filled so full that the liquid wets the stopper; and the bottle must be lowered carefully, but as

rapidly as possible, on to the glass rod by sliding it down the side of B with a strip of paper folded lengthwise into the shape of a V. To prevent vaporization as far as possible while the weighing bottle and liquid rest on the rod at D, the upper end of the tube B should be protected from the heat of the flame and the bath A, by means of a sheet of asbestos board, placed on the top of the cork closing the mouth of A.

To prevent the bottom of the tube B being broken by the fall of the weighing bottle, a small quantity of mercury should be poured into B before commencing the experiment, provided the temperature employed is not much above 150°. When high temperatures are used, a small pad of asbestos fibre can be used instead of the mercury.

After each experiment, all vapour must be removed from the tube by blowing air through the latter.

The error in the determination of the density by the above method should not exceed 5 per cent.

EXPERIMENT.—*Determine the Density and Molar Weight of Acetone or of Chloroform Vapour.*

The experiment is carried out as described above, water being used as heating liquid.

Calculation.—Let—

v be the volume of the air expelled, measured in c.c. ;

t the temperature of the air ;

b the barometric pressure ;

f the vapour pressure of water at the temperature t (*vide infra*) ;

W the weight in gm. of the substance taken.

Then the volume of the air expelled reduced to N.T.P. will be—

$$v_0 = \frac{v \times 273 \times (b - f)}{(t + 273) \times 760}$$

v_0 is therefore equal to the volume which W gm. of the vapour would have at N.T.P., and the weight of 1 c.c. of the vapour

would therefore be $\frac{W}{v_0}$. Since 1 c.c. of the fictitious gas which we have chosen as the unit of density (p. 45) weighs 0.0004465 gm., the density of the vapour referred to this unit will be—

$$d = \frac{W}{4.465 \times 10^{-5} \times v_0} = 22400 \frac{W}{v_0}$$

This number also represents the molar weight of the vapour.

The value of the vapour pressure of water at different temperatures is given in the following table :—

VAPOUR PRESSURE OF WATER IN MILLIMETRES OF MERCURY

t°	p	t°	p	t°	p
0	4.6	11	9.9	21	18.6
1	4.9	12	10.5	22	19.8
2	5.3	13	11.2	23	21.0
3	5.7	14	12.0	24	22.3
4	6.1	15	12.8	25	23.7
5	6.6	16	13.6	26	25.2
6	7.0	17	14.5	27	26.7
7	7.5	18	15.5	28	28.3
8	8.1	19	16.5	29	30.0
9	8.6	20	17.5	30	31.7
10	9.2				

2. *Lumsden's Method.*—In Victor Meyer's method, as we have seen, the pressure is maintained constant (equal to that of the atmosphere), and the increase in volume due to the formation of vapour is determined. In Lumsden's method, however, the volume is maintained constant, and the increase in pressure measured.

Before using this method, read through the description of the Victor Meyer apparatus and method.

The apparatus is shown in Fig. 13. The vaporization tube

B is essentially the same as in the Victor Meyer apparatus, only much shorter. It is fitted into the wide boiling-tube A,

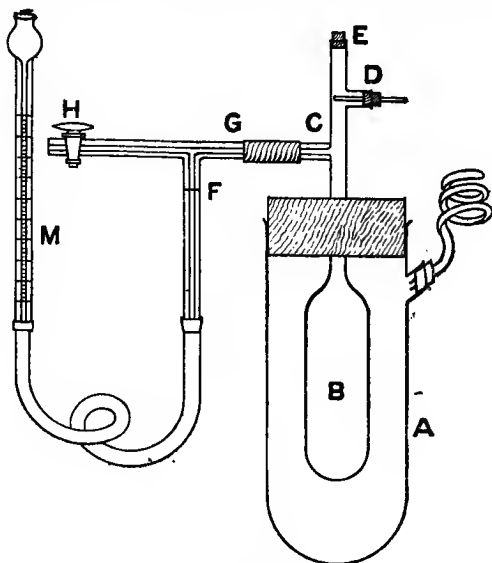

FIG. 13.

which carries a spiral glass condenser, by means of an india-rubber bung.¹

¹ In the original apparatus described by Lumsden, the boiling-tube was sealed to the neck of the vaporization tube. This has the advantage that heating liquids which attack rubber can be used. It has, however, the disadvantage that the apparatus is thereby rendered considerably more expensive, and if the outer boiling-tube is broken, repair is impossible. It is much better, therefore, in all cases in which the heating liquid permits of a rubber bung being used, to adopt the apparatus as shown in Fig. 13.

In Lumsden's original apparatus, also, the horizontal capillary CG consisted of one piece. As this is very liable to be broken, it is better to cut the capillary, and connect the two pieces by means of thick-walled rubber tubing. In doing this, the two ends of glass tube should be brought up close to each other, and the rubber tubing should also be wired on.

The apparatus is best supported on a square asbestos heating box, and while the liquid in A is being boiled (use porous tile to avoid bumping), the stop-cock H is kept open to the air. To protect the upper part of the tube B from the hot air, a sheet of asbestos board, cut with a hole for the passage of the tube, is placed on the top of the rubber bung.

The perpendicular capillary tube F, on which there is a fixed mark, is connected by means of thick-walled rubber tubing with the tube M, which is graduated in millimetres. The ends of the rubber tube must be wired to both F and M. This tube must be filled with so much mercury that when the mercury in F is at the fixed mark, the meniscus in M is at the top of the graduated portion, or even a little above it. Care must be taken that the mercury forms a continuous thread unbroken by air-bubbles.

The preliminary heating of the vaporization tube is carried out as with the Victor Meyer apparatus. The attainment of constant temperature is shown by the mercury in tube F remaining stationary when the stop-cock H is closed.

When constant temperature has been attained, introduce the weighing bottle with substance as with the Victor Meyer apparatus, and replace the stopper at E. Adjust the mercury so that it stands at the fixed mark on F, close the stop-cock H, and then allow the weighing bottle to fall to the bottom of B, which must be protected by mercury or asbestos.

As the liquid vaporizes in B, the pressure in the apparatus will increase. The mercury should always be kept near to the mark on F by raising the tube M. When the vaporization is complete and the mercury has become stationary, place the manometer tube M close to the tube F, and adjust the level so that the mercury stands at the mark on F. Then read off the difference in height (p) of the two mercury surfaces. This represents the increase of pressure due to the vapour produced.

With the Lumsden apparatus, two methods can be employed for obtaining the value of the vapour density—a comparison method and an absolute method:—

a. Comparison Method.—First determine the increase of pressure (difference of level of the two mercury surfaces) produced by a known weight of a substance, the molar weight of which is also known. From this calculate, by simple proportion, the difference of level which would be produced by 1 mole of the substance. Then determine the pressure produced by a known weight of the substance, the density of which is desired, and calculate from this how many grams of it would be required to give a pressure equal to that produced by 1 mole of the known substance. The number thus obtained represents the molar weight of the substance, and also the density referred to that of oxygen equal to 32 (p. 45).

After each experiment, all vapour must be removed by a current of air.

b. Absolute Method.—In using this method, the volume of the vaporization tube must be determined, by weighing the tube empty and then full of water. In doing this the outer boiling-tube A should be removed, and the connection between C and G broken. (Decide with what accuracy this weighing must be done.)

Let v_1 be the volume of the vaporization tube, b the barometric pressure, and p the increase of pressure, in millimetres of mercury, produced by the vaporization of a known weight (W gm.) of the substance. If the pressure were kept constant and equal to b , the volume of the air + vapour would be, say, v_2 . In order to reduce this volume to v_1 , the pressure $b + p$ is necessary. Hence, since the product of pressure and corresponding volume is constant, we obtain $bv_2 = (b + p)v_1$, or $v_2 = \frac{v_1(b + p)}{b}$. But the volume of the air under the pressure b is v_1 . Hence the volume of the vapour under atmospheric

pressure b is $\frac{v_1(b+p)}{b} - v_1 = \frac{v_1 p}{b}$. This, then, is the volume of W gm. of vapour under the pressure b and at the temperature (t) of vaporization (boiling-point of the heating liquid). The volume at N.T.P. is therefore—

$$v_0 = \frac{v_1 p \times 273 \times b}{b \times (t + 273) \times 760} = \frac{v_1 p \times 273}{(t + 273) \times 760}$$

As before, therefore (p. 54), the density referred to that of oxygen equal to 32, and also the molar weight are equal to—

$$M = d = 22400 \frac{W}{v_0}$$

The error in the determinations should not exceed 5 per cent.

EXPERIMENT.—*Determine the Vapour Density and Molar Weight of Acetone.*

1. Make two determinations of the increase of pressure produced by known weights of chloroform, and calculate from these values the increase of pressure which would be produced by 1 mole of chloroform. Then determine (after removing the vapour from the tube) the increase of pressure produced by a known weight of acetone. From the value obtained, and from the mean of the two values obtained with chloroform, calculate the density and molar weight of acetone.

2. Determine the volume of the vaporization tube and the increase of pressure produced by a known weight of acetone. Calculate the molar weight of acetone, and compare the value so obtained with the value obtained in the previous experiment by the comparison method.

Other Methods of determining Vapour Densities.—

Besides the methods of Victor Meyer and of Lumsden, others have been used for the determination of vapour densities, e.g. the methods of Dumas and of Hofmann. These methods, however, although at one time frequently employed, are now seldom used; and need not be further discussed. More recently,

however, two methods have been suggested by Blackman and by Menzies for the determination of vapour densities, which deserve attention as they are easy to carry out and yield as accurate results, at least, as those already described. The methods are, in principle, the same; and depend on determining the *pressure* produced by the vaporization of a known weight of substance into a closed space.

Apparatus of Blackman.—A diagram of the apparatus proposed by Blackman is shown in Fig. 14.¹ It consists of a

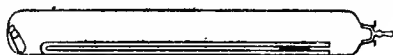

FIG. 14.

tube (vaporization tube) sealed at one end, and having at the other end a conical neck (with its narrower end outwards), into which there fits, very closely, a hollow stopper. Into this tube there are introduced a weighing bottle containing a known weight of the substance to be vaporized, and also a capillary tube, closed at one end and having a short thread of mercury in the bore near the other end. This tube serves as a manometer.

Carrying out a Determination.—A short thread (about 1.5 cm.) of mercury must first be introduced into the capillary tube, which should have a bore of about 1.5 mm. This is readily done by slightly heating the capillary tube in a flame, and then allowing it to cool with the open end under mercury. When a sufficient amount of mercury has been sucked into the bore, the tube is withdrawn and laid aside in order to acquire the room temperature. The thread of mercury should now stand about 1-2 cm. from the open end of the tube. When the position of the mercury has become fixed, the length of the air space enclosed by it is determined by means of a

¹ The apparatus is supplied by Messrs. F. E. Becker & Co., Ltd., 17-27, Hatton Wall, London, E.C.

millimetre measure. The capillary tube, with its thread of mercury, is then slid inside the vaporization tube, which must previously have been cleaned and thoroughly dried. Into the vaporization tube there is also brought a weighing bottle containing a known amount of the substance to be vaporized; and the tube is then closed by pulling the stopper into place by means of a stout string, previously attached to the head of the stopper. In carrying out this operation some care must be exercised in order to avoid alteration of the pressure of air inside the vaporization tube either (1) through suction, by drawing the stopper too rapidly into place, or (2) through handling, by raising the temperature of the tube and so causing a diminished pressure when the closed tube is again allowed to cool down to the atmospheric temperature.

Having, with proper precaution, fixed the stopper firmly in the neck of the vaporization tube, the latter is placed in a horizontal position and the length of the air-column in the manometer tube again measured, after the tube has taken the temperature of the air. This value will be the same as that found previously, provided the necessary precautions, mentioned above, have been observed in closing the vaporization tube.

The apparatus is now placed, in a horizontal position, in a suitable heating jacket, which may be either a tube through which the vapour of a substance boiling at a suitably high temperature (see Appendix) is passed, or a bath or trough filled with a liquid (water, concentrated solution of calcium chloride, glycerol, etc.), kept at a suitable temperature. The exact temperature of this bath does not require to be known, provided the vaporized substance does not undergo molecular change (association or dissociation) with change of temperature.

When the substance has completely vaporized, and the mercury thread in the manometric tube has become stationary,

the length of the enclosed air-space is again measured.¹ This measurement is effected most easily with the aid of a pair of callipers or compasses. Owing to the increase of pressure produced in the vaporization tube by the vapour of the substance, the length of this air-thread will now be less than at atmospheric pressure.

The vaporization tube is now removed from the heating jacket or bath, cooled, and opened by gently tapping the stopper, to the head of which a string should be attached, to prevent it from being sucked violently inwards, with the consequent risk of breakage. The manometer and the weighing bottle (unstoppered) are removed and dropped into a burette containing water, whereby the combined volume of the manometer and weighing bottle can be determined. The difference between this volume, and that of the vaporization tube (marked on the latter by the makers), represents the volume occupied by the heated air and the vapour of the substance.

Calculation of the Vapour Density.—This method of determining the vapour density depends, as has been indicated, on measuring the pressure produced by a given weight of vapour, occupying a given volume at a given temperature; and the pressure which is so produced is measured by the diminution in the length of the air-column enclosed by the mercury thread in the manometer tube.

Let w = the weight of substance vaporized.

t_1 = the atmospheric temperature.

t_2 = the vaporization temperature.

p = the atmospheric pressure.

L = the length of the air-thread in the manometer at t_1° , before the vaporization tube is closed.

¹ In order to shorten the time necessary for the manometer tube to take up the temperature of the bath, capillary tubing should be selected with fairly thin walls.

L_o = the length of the air-thread in the manometer at t_1° , after the vaporization tube is closed.

l = the length of the air-thread in the manometer at t_2° .

V = the volume of the vaporization tube minus the combined volume of manometer and weighing bottle.

The initial internal pressure, π , in the manometer is then given by $\pi = \rho L/L_o$. At the temperature t_2° when the air-thread has been compressed from the length L_o to the length l , the pressure within the manometer will have increased from

π to $\frac{\pi(L_o - l)}{l} \cdot \frac{(273 + t_2)}{(273 + t_1)}$; or the manometric pressure will

now be $\frac{\rho L(L_o - l)}{L_o \cdot l} \cdot \frac{(273 + t_2)}{(273 + t_1)}$.

On the other hand, the volume of the vapour of the substance at 0° and 760 mm. pressure is $11,160w/d$ (the volume of 1 gm. of hydrogen at N.T.P. being taken as 11,160 c.c.). At the temperature t_2° , and when occupying the volume V , the

pressure will be $\frac{11,160 \cdot w \cdot (273 + t_2) \cdot 760}{d \cdot V \cdot 273}$. But this pressure

must be equal to the manometric pressure, and hence,

$$\frac{\rho L(L_o - l) \cdot (273 + t_2)}{L_o \cdot l \cdot (273 + t_1)} = \frac{11,160 \cdot w \cdot (273 + t_2) \cdot 760}{d \cdot V \cdot 273}$$

From which one obtains the density (referred to that of hydrogen as unity),

$$d = \frac{31,068 \cdot w \cdot l \cdot L_o \cdot (273 + t_1)}{\rho \cdot V \cdot L(L_o - l)}$$

It may be mentioned that in the above deduction, the change in the value of V owing to the displacement of the mercury thread in the manometer when the substance vaporizes, has been neglected, as being small compared with V .

Apparatus of Menzies.—For the determination of vapour densities, the apparatus described later (p. 150) can, when slightly modified, be employed. The modification consists in

the following. Six or eight cubic centimetres of pure mercury are poured into the "test-tube" of the apparatus, in order to close the end of the gauge tube. This mercury also serves the purpose of a manometer liquid.

The substance to be vaporized is weighed in a small bulblet whose attached capillary, 2-3 cm. in length, is sealed off before the final weighing. A file mark is then made on the neck of the bulblet and the latter attached to the stopper of the "test-tube" by pushing the bulb capillary into a hole drilled obliquely in the end of the stopper, and fixing it there by means of dry asbestos fibre. In this way it can be arranged that, on replacing the stopper, with the attached bulblet, in the neck of the "test-tube," the neck of the bulblet can be broken by rotating the stopper and so causing the bulblet to be forced against the top of the gauge-tube.

Carrying out a Determination.—Before using the apparatus for the determination of vapour densities, the "constant" of the apparatus at the particular temperature of vaporization employed must be determined. For this purpose it is convenient to determine the pressure produced in the "test-tube" by the vaporization of a known weight of pure benzene, or other normal substance, of known molecular weight. Having placed a known volume of mercury in the bottom of the "test-tube," as mentioned above, and having carefully introduced the stopper with a weighed bulblet of benzene attached to it, the heating liquid is caused to boil. As the air in the "test-tube" is warmed, mercury rises a few millimetres in the gauge-tube. When the temperature has become constant, the level of the mercury in the gauge-tube is noted and the neck of the bulblet containing the benzene is then broken by rotating the stopper. The benzene rapidly vaporizes, the level of the mercury in the gauge-tube rises, and after five or six minutes again becomes steady. The observed rise of mercury in the gauge-tube must be corrected by addition of

the simultaneous slight fall in the level of the mercury in the "test-tube." (The relation between a given rise in level of the mercury in the gauge-tube to the corresponding fall in level in the "test-tube" may be determined once for all. For any subsequent observed rise in the gauge-tube, the corresponding fall in the "test-tube" can then be obtained by simple proportion.) Having now determined the rise of mercury in the gauge-tube, in millimetres, obtained with a given weight of benzene, one can calculate the rise which would be obtained with one mole of benzene. This number represents the "constant" of the apparatus at the particular temperature of vaporization employed. The molar weight of any other volatile substance at this temperature can then be obtained by means of the formula $M = K \cdot w/R$, where K is the "constant" of the apparatus, and R is the corrected rise of mercury in the gauge-tube produced by the vaporization of w grams of substance.

If the same amount of mercury is placed in the "test-tube" for each experiment, the "constant" of the apparatus can be noted once for all and need not be redetermined in subsequent experiments.

After each determination the vapour must be completely removed from the "test-tube" by means of a current of air.

Associating and Dissociating Substances.—In the case of certain substances it is found that the molar weight, calculated from the vapour density, has a value sometimes greater and sometimes less than that corresponding with the formula which, on other grounds, must be assigned to the substance; and it is also found that in those cases, the vapour density is not independent of, but alters with, the temperature. These cases of abnormal vapour densities, as they were termed, are accounted for by the assumption of association or of dissociation of the molecules of the substance in the vapour state; and from the values of the density obtained one can

calculate the degree of association or of dissociation at the temperature of the determination.

For the purpose of such determinations the Victor Meyer, or, preferably, the Lumsden method may be employed. The method of Blackman and of Menzies is not so suitable on account of the fact that diffusion of the vapour throughout the whole vaporization space occurs, whereby the partial pressure of the vapour is reduced. In accordance with the theorem of Le Chatelier, however, this reduction in the partial pressure causes an increase in the dissociation.

Since the same process of diffusion of the vapour will occur, in course of time, also in the Victor Meyer or Lumsden apparatus, it is essential that the determination shall be carried out as rapidly as possible.

If a is the degree of association or of dissociation, and if n is the number of simple molecules which combine to form the associated molecule, or is the number of simpler molecules formed by the dissociation of a more complex molecule; and if d_0 is the observed vapour density, and d_t the theoretical (normal) vapour density; then, since the vapour density is inversely proportional to the number of molecules, we obtain

$$a = \frac{d_0 - d_t}{d_0 \left(1 - \frac{1}{n} \right)}$$

in the case of associating substances; and

$$a = \frac{d_t - d_0}{d_0(n - 1)}$$

in the case of dissociating substances.

EXPERIMENT.—Determine by the Victor Meyer or Lumsden method,¹ the vapour density of acetic acid at a series of

¹ It may be pointed out that accurate determinations of the vapour density of associating and dissociating substances cannot be carried out even with the Victor Meyer or the Lumsden apparatus, on account of the impossibility of preventing completely the diffusion of the vapour and the

temperatures between 140° and 240° . (For suitable heating liquids, see Appendix.) Plot your results to show the variation of the vapour density with the temperature, and calculate the degree of association at 180° . To break the fall of the weighing bottle, use a pad of asbestos fibre or a layer of dry quartz sand.

EXPERIMENT.—Determine the vapour density of phosphorus pentachloride at temperatures between 180° and 240° , and calculate therefrom the degree of dissociation of the pentachloride into trichloride and chlorine.

Analysis of Binary Mixtures.—A useful application of vapour density determinations is to the analysis of binary mixtures of (normal) liquids, the vapour density of which is known.

We have $\frac{W}{d} = \frac{w_1}{d_1} + \frac{w_2}{d_2}$, where w_1 and w_2 , are the weights of the two liquids contained in W grams of the mixture, and d , d_1 and d_2 are the vapour densities of the mixture and of the single components. Hence

$$\frac{w_1 d_2 + w_2 d_1}{d_1 d_2} = \frac{W}{d}$$

From this, knowing the values of d_1 and d_2 , W and d (determined experimentally), and remembering that $w_1 + w_2 = W$, the values of w_1 and w_2 can be calculated.

EXPERIMENT.—*Determine the Solubility of Carbon Disulphide in Methyl Alcohol at 25° .*

A mixture of pure carbon disulphide and methyl alcohol, contained in a stoppered bottle, is placed in a thermostat at 25° for 15–20 minutes, and is shaken at frequent intervals. It is then allowed to stand at rest till separation of the mixture into two layers has taken place. A portion of the consequent alteration of its degree of association or dissociation. The error, however, will be all the less the more rapidly vaporization takes place (remove the stopper from the weighing bottle) and the narrower the vaporization bulb of the apparatus.

upper layer is then pipetted off, a small quantity weighed in a small weighing bottle, and the vapour density then determined. The relative amounts of the two components is then calculated as above. (Compare Rothmund, *Zeitschr. physikal. Chem.*, 1898, 26, 475.)

References.—Bleier and Kohn, *Monatsh.*, 1899, 20, 505; Lumsden, *Trans. Chem. Soc.*, 1903, 83, 342; Blackman, *Chem. News*, 1907, 96, 223; 1908, 97, 27, 102; 1909, 99, 87, 133; 1909, 100, 13, 129, 174; *J. Phys. Chem.*, 1908, 12, 661; 1909, 13, 138, 426; Menzies, *J. Amer. Chem. Soc.*, 1910, 32, 1624.

CHAPTER IV

THERMOSTATS

As very many of the measurements in physical chemistry are markedly affected by temperature, it is necessary to have some means whereby experiments can be carried out at constant temperature. Constant temperature baths, or *thermostats*, are, therefore, a very essential part of the equipment of a physical chemical laboratory.

The method employed for obtaining a constant temperature will, of course, depend largely on the temperature required. Occasionally, changes of physical state, *e.g.* fusion and vaporization, in which the temperature is maintained constant by the process itself, can be employed with advantage; more especially is this the case when boiling liquids can be used. This method finds its chief application when the apparatus can be entirely surrounded by a jacket filled with the vapour of the boiling liquid, *e.g.* in the Victor Meyer or Lumsden apparatus for the determination of vapour densities (p. 49). The method has the disadvantage that one is bound more or less to certain fixed temperatures; for although variations can be obtained by artificially controlling the pressure under which the liquid boils, the apparatus thereby becomes much more complicated.

The melting of substances may also be used to produce constant temperatures, and in this connection the substance most commonly employed is ice. If a temperature of 0° is

desired, ice can be used, but it must be pure. It is therefore best to employ the ordinary ice to surround a vessel containing partially frozen distilled water.

In a similar manner other temperatures dependent on the existence of invariant systems can be obtained, *e.g.* cryohydric temperatures and transition temperatures of certain salt hydrates. (See Table I., Appendix.)

In by far the largest number of cases, however, constant temperatures are obtained by means of liquids, more especially of water. When the desired temperature is above that of the surroundings, heat is added to the bath to make up for the loss by radiation; if the desired temperature is below that of the surroundings, the temperature is kept constant by adding cold water to the bath.

The Bath.—The vessel for the constant-temperature liquid may vary, both as regards size and material, according to the purpose for which it is to be employed. For most purposes enamelled iron vessels are exceedingly convenient; or one may also use galvanized iron baths, which are everywhere obtainable at a small price. In the case of the latter, the inside of the bath should be painted either with ordinary white enamel, or, better, with "velure" paint. In all cases it is better to surround the outside of the bath with felt.

For some purposes, *e.g.* measurements of viscosity, it is necessary to have a transparent bath, or at least a bath with one of its sides transparent. In this case, a large beaker will often serve the purpose admirably. Or, if the temperature required is not very high, an inverted glass bell-jar can also be used; but in general a metal bath fitted with glass sides will be preferred. Such a bath can be easily and cheaply made by having a strip of sheet iron bent so as to form two sides and the bottom of the bath, and furnished with flanged edges. The other two sides of the bath are then formed by clamping sheets of plate glass against the flanges, the joint being rendered

water-tight by the insertion of rubber tubing between the glass and the metal flange.

As *bath liquid*, the most convenient is, of course, water. This can be used for all temperatures up to near its boiling-point; but when the temperature employed is higher than about 50° , it is well to cover the surface of the water with a layer of olive or paraffin oil, to prevent evaporation. The presence of these is, however, always more or less objectionable, and they can in general be dispensed with if a constant level apparatus is employed. For temperatures over 100° and up to 140° - 150° , a concentrated solution of calcium chloride can be employed.

Constant Level Apparatus.—When the temperature is fairly high, or when the bath is to be in use for a considerable time,

it is convenient to have some arrangement for repairing loss by evaporation and maintaining the level of the water in the thermostat. This can be effected in various ways. A side tube of the form shown in Fig. 15 may be permanently attached to the bath; water passes into the side tube and the bath through *a*, and the excess flows out through *b*. The water is therefore maintained at the level of the upper end of *b*.

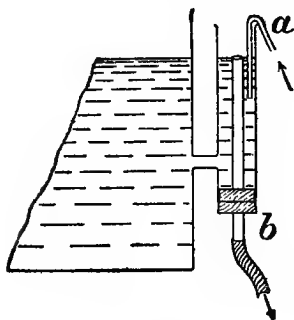

FIG. 15.

Even when the thermostat is not furnished with this constant-level apparatus, the same device, in a modified form, can readily be made from ordinary laboratory materials and used with any thermostat. This form of the apparatus is shown in Fig. 16.

This apparatus is constructed of glass tubing fitted together as shown in the figure. Before using, the tubes E, F, and D

are filled with water; and after the tube B has been filled with water up to the end of the waste-pipe C, water will syphon off from B into the thermostat W, until the level of the water in the latter rises to that in the tube B. The apparatus then acts in exactly the same manner as that shown in Fig. 15.

The tube E, it may be mentioned, is necessary in order to act as an air-trap. By this means the blocking of the syphon tubes by air-bubbles given off from the water is prevented. When too much air begins to collect in E, it can be removed by sucking through the rubber tube G which is ordinarily closed by means of a screw-clip.

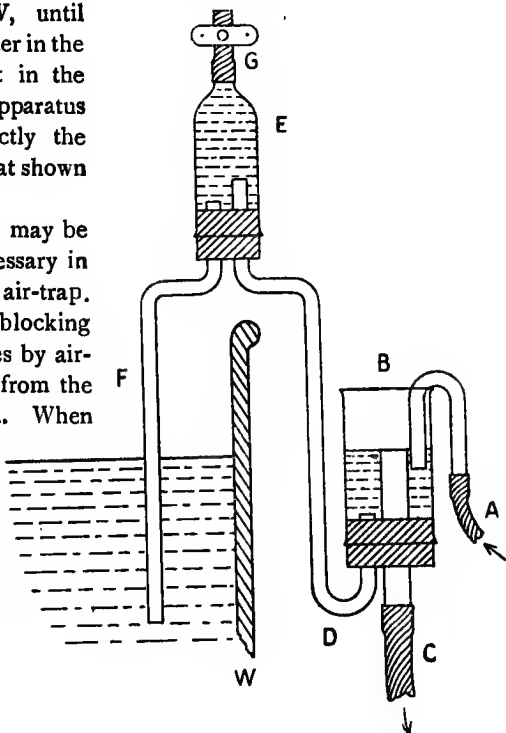

FIG. 16.

Regulation of the Temperature.

—When temperatures above that of the surroundings are to be maintained, heat must be added to the bath. This is generally effected by means of a gas flame, the size of which is automatically regulated by means of a thermostat.

Various forms of gas thermo-regulators have been introduced; one of the most suitable for ordinary purposes is shown in Fig. 17, which is very suitable when the vessel is not too large, and where the bath liquid is efficiently stirred. The wide end of the tube A is filled with toluene (on account of its considerable thermal expansibility and its fairly high boiling-point), while the bend and the narrow upright tube are filled with mercury. The upper end of the tube is of small bore, in order to increase the sensitiveness of the regulator by giving a relatively large rise and fall of the meniscus for a given change of volume of the toluene. The gas passes in through the tube B, which is fixed by means of a cork in the upper expanded end of the regulator tube, and thence through the side tube C to the burner. If the temperature of the bath should rise too high, the toluene expands and raises the surface of the mercury in the narrow tube, thus closing the end of the inlet tube B, and cutting off the gas supply. In order that the flame may not be completely extinguished, there is a side tube D (a by-pass), of india-rubber, through which gas passes directly to the burner. The clip on the rubber tube should be so regulated that the amount of gas which passes when the end of B is closed by the mercury, is just insufficient to maintain the thermostat at the desired temperature. When the end of the tube B is closed, therefore, through the elevation of the mercury, the flow of heat to the thermostat will be diminished; the temperature will fall, the toluene will contract, the mercury

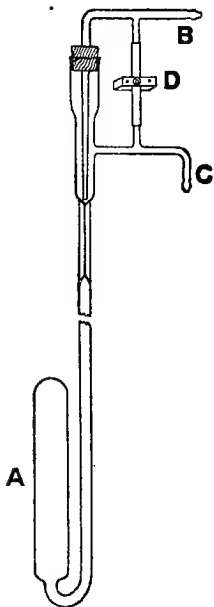

FIG. 17.

and cutting off the gas supply. In order that the flame may not be completely extinguished, there is a side tube D (a by-pass), of india-rubber, through which gas passes directly to the burner. The clip on the rubber tube should be so regulated that the amount of gas which passes when the end of B is closed by the mercury, is just insufficient to maintain the thermostat at the desired temperature. When the end of the tube B is closed, therefore, through the elevation of the mercury, the flow of heat to the thermostat will be diminished; the temperature will fall, the toluene will contract, the mercury

meniscus will fall and so open the end of B again, and allow a larger supply of gas to pass. By means of this regulator, therefore, there will be a fluctuation of temperature about a certain mean value; but if the regulator is working properly, the fluctuation should not exceed 0.1° .

Filling and Adjusting the Thermo-regulator.—Remove the inlet tube B and close the upper end of the regulator tube by means of an unbored cork. To the end of the exit tube C attach, by means of a piece of india-rubber tubing, a glass tube furnished with a stop-cock. Attach the end of the rubber tube D to a water pump, and exhaust the regulator, the stop-cock attached to C being meanwhile closed. Then close D, and open C under toluene. After toluene has passed into the apparatus, close C and again exhaust, placing the tube this time in a beaker of warm water, so that the toluene boils and expels the air. Close D and open C again under toluene, when a further quantity of toluene will enter the regulator. This operation must be repeated, if necessary, until the tube A is nearly full of toluene. Now remove the cork closing the end of the regulator tube, and pour in a quantity of mercury; replace the cork, and, inclining the tube so that the mercury leaves the end of the capillary free, exhaust the tube once more; place the tube upright and admit air. This operation must be repeated until there is sufficient mercury in the regulator. The amount of mercury will, of course, depend on the temperature at which the regulator is to be used; for ordinary purposes, one may introduce sufficient mercury to fill the narrow upright tube and form a layer about 1–1.5 cm. deep in the wide tube A. Any toluene which may have collected on the top of the mercury must be removed by means of a plug of cotton-wool, or by means of filter paper.¹

¹ If sufficient care is exercised, the following method of filling the regulator may be employed: Warm the bulb A so as to expel some of the air, and then dip the end of the exit tube under toluene. As the bulb

The quantity of mercury must now be roughly adjusted for the temperature at which the regulator is to be used. For

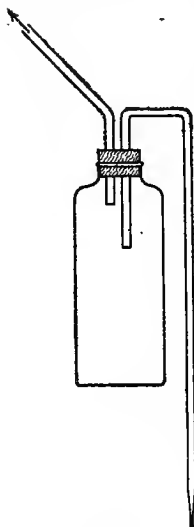

this purpose, the regulator is placed in a bath of water at the desired temperature for several minutes. If too much mercury has been introduced, the excess is removed by means of a pipette (for which purpose that shown in Fig. 18 is very useful), until the mercury meniscus occupies the lower end of the tube above the capillary. If too little mercury has been introduced, then the regulator should be placed in a beaker of warm water so that the surface of the mercury rises above the end of the capillary, and a further quantity of mercury should then be poured in. The regulator is then placed in the bath again and the level of mercury adjusted. The exact adjustment is carried out by means of the inlet tube B.

FIG. 18.

Where the bath is larger, it is preferable that the regulating bulb should be laid along the bottom of the bath. In this case the form of regulator shown in Fig. 19 is very suitable. The large bulb, which rests on the bottom of the thermostat, has a long bent neck which passes up the side of the thermostat and connects with a U-tube, the bend of which is filled with mercury. The bulb and connecting tube may be filled either with toluene (in which case the connection at *a* must be made without rubber), or, as is also very suitable for many purposes, with a 10 per cent. solution of calcium chloride.

cools, toluene will be drawn into the tube. Re-warm the tube, and again allow toluene to be drawn into the regulator; and proceed in this way till the tube is full.

As indicated in Fig. 19, the regulating liquid fills the bulb and part of the adjacent limb of the U-tube. The small

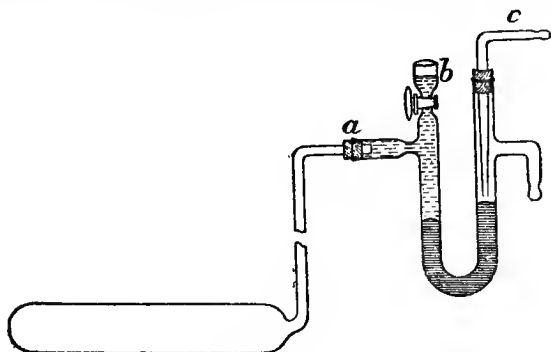

FIG. 19.

reservoir *b* serves to regulate the amount of liquid in the bulb, and thus roughly to adjust the temperature. The stop-cock connecting the reservoir with the U-tube should be left open until the temperature of the bath has come to within one or two tenths of a degree of the desired temperature. The final adjustment is then made by raising or lowering the gas inlet tube *c*.

The regulator can be made more sensitive by arranging that the U-tube also is immersed in the water of the thermostat, whereby the mercury is withdrawn from the influence of changes of temperature outside the bath.

The maintenance of a constant bath temperature lower than that of the surroundings is effected by means of a regulated stream of cold water. For this purpose the Foote regulator is very suitable (Fig. 20). This is filled with toluene and mercury as in the case of the gas regulator shown in Fig. 17, and the adjustment of the mercury level is effected by means of the screw working in the side tube *e*. A slow

stream of ice-cold water flows in at *h*. When the temperature of the bath is below the desired temperature, the mercury in *c* falls and the end *d* of the tube *f* is opened. The cold water thus flows out through the tube *f* to the waste. As the temperature rises, the mercury also rises and closes the opening *d*, and the ice-cold water now flows out through *g* to the bath. The amount of water flowing through *h* must not be too great, and must be so regulated that it can be carried away by the tube *df* when the latter is open.

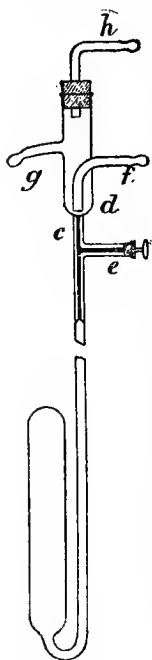

FIG. 20.

Stirrers.—In order to maintain a uniform temperature throughout the bath, it will be found necessary in most cases to stir the water. In many cases, where the temperature is not too high, and where, therefore, evaporation is not too great, the stirring may be effected by means of a current of air. A piece of soft metal tubing (compo. tubing), closed at one end and bent in the form of a ring, is laid on the bottom of the thermostat, and the open end of the tube, which passes up above the surface of the water, is attached either to a supply of compressed air, or to a blower. The ring of tubing in the bath is pierced at intervals by a number of pin-holes, through which the air can escape and thus stir the water.

A convenient water-blower can be fitted up as shown in Fig. 21. Into the neck of a moderately large aspirating bottle, *a*, are fitted air-tight, by means of a rubber stopper, the filter pump *b*, connected with the water supply, and the outlet tube *c*. Water, carrying air with it, passes into the bottle, where the water collects while the air passes out through *c*. The pressure

is regulated by regulating the flow of water through the tap *d* (which can also be replaced by india-rubber tubing and a screw-clip).

In general, however, a mechanical stirrer driven by a water turbine, hot-air engine, or electric motor, will be found most convenient. These stirrers may be of very varied form,

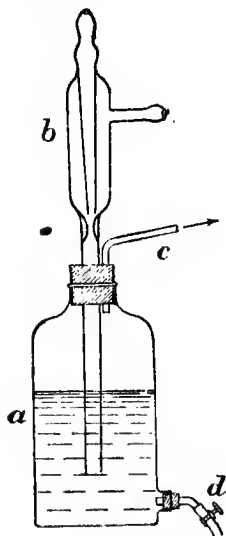

FIG. 21.

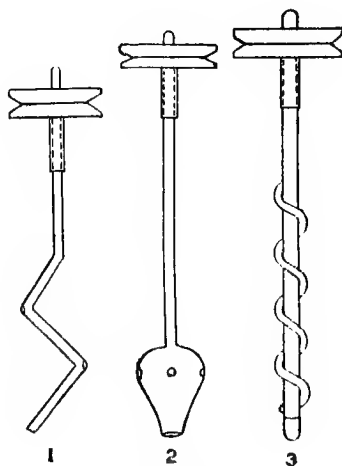

FIG. 22.

according to particular requirements. Stirrer 1 (Fig. 22) is perhaps the simplest, while it is at the same time very efficient. It consists of a glass tube bent sharply as shown, and at each bend a hole is blown in the glass.

When the thermostat is narrow (*e.g.* a beaker), and when it contains apparatus permitting of little room for the stirrer, either of the forms shown in 2 or 3 is very convenient. In 2, the Witt stirrer, water is drawn in at the lower end of the bulb

and thrown out at the sides. Stirrer 3 consists of a glass or metal rod to which a spirally bent tube is attached. The stirrer is rotated in the direction in which the lower end of the tube points, the water being thus forced up the tube.

As a bearing for the different stirrers, one may employ a piece of glass or metal tubing, slightly wider than the stem of the stirrer. If kept well lubricated by means of vaseline, this makes, on the whole, a fairly satisfactory bearing. For long-continued use, however, and especially when the rotation of the stirrer is rapid, a much better bearing is obtained by using a bicycle hub with ball bearings. In this case the stirrer is attached to the axle either by means of sealing-wax or Chat-terton cement, but preferably by means of a screw-cap, whereby different forms of stirrer can be fixed to the same hub. The driving pulley is screwed on to the upper end of the axle.

Fitting up a Thermostat.—The bath having been placed in position, the regulator (filled and adjusted according to p. 73), the thermometer graduated in tenths of a degree, and the stirrer, are supported within the bath by means of retort clamps. The regulator is then connected with the gas supply and with the small burner for heating the bath.¹ For temperatures up to about 40°, a small burner giving a luminous flame may be used, and the flame should be protected from draughts by means of a cylinder of glass, mica, or asbestos. (The jet of a Bunsen burner from which the tube has been removed is very suitable for this purpose.) For higher temperatures—above 50°—the large luminous flame necessary to maintain the temperature will give rise to too much soot. It is, therefore, better to supply most of the heat to the thermostat by means of a Bunsen flame which is so regulated that, by itself, it maintains the temperature about half a degree below

¹ For all connections of this nature, compo. tubing is very suitable; it is not only less expensive than rubber tubing, but there is not the same danger of the gas supply being accidentally cut off owing to compression of the tube.

that desired. The maintenance of the desired temperature is then effected by means of the luminous flame attached to the regulator. One may also use a Bunsen burner alone, connected with the thermo-regulator. Whenever a Bunsen flame is used, a gauze-cap or a rose burner should be placed on the end of the tube, to prevent the flame striking back.

In fitting up a thermostat for the first time, the latter should be filled with warm water of nearly the desired temperature, and the temperature then further raised by means of Bunsen burners. In this way, raise the temperature, moderately slowly towards the end, to about 0.1° below the desired temperature; light the burner connected with the regulator, and adjust the gas inlet tube of the latter so as just to touch the top of the mercury. It will then soon be ascertained whether the tube must be slightly raised or slightly depressed further. The by-pass should be so regulated that when the end of the inlet tube is closed, the flame is just insufficient to maintain the desired temperature.

For supporting flasks and other vessels in the thermostat, a sheet of stout galvanized iron or copper netting can be suspended from the edge of the thermostat by means of wire hooks.

Circulation of Water.—The maintenance of a constant temperature in apparatus outside the thermostat (*e.g.* refractometer) is most easily effected by passing through the apparatus a stream of water heated to the desired temperature by passing through a coil of metal tubing (compo. tubing) immersed in the thermostat. In this case, as there is a fall of temperature outside the thermostat, the temperature of the latter will require to be regulated to a slightly higher temperature than that desired in the apparatus. The necessary temperature will, of course, depend on the length of the outside circuit and the velocity of the stream of water, and must be determined by trial. A preferable method is, however, to circulate water from the thermostat by means of a pump.¹

¹ Such as is supplied by the Albany Engineering Co., Ossory Road, London, S.E.

For most purposes it will be found that the Luther pump¹ is very efficient and convenient to use. A diagram of this

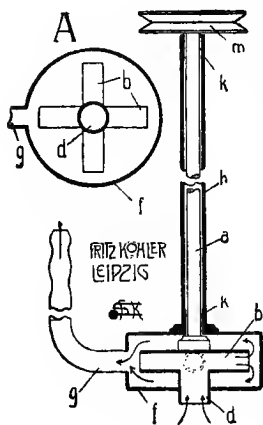

FIG. 23.

pump is shown in Fig. 23. Attached to the pulley *m*, is the rod *a*, which carries at its lower end, the four hollow arms *b*, with which there also communicates the tube *d*. This series of tubes is enclosed within the metal box *f*, furnished with the outlet tube *g*. The axle rod, *a*, runs in the bearings *k* enclosed within the tube *h*.

To use this pump for the circulation of water at constant temperature, it is clamped to the side of a thermostat so that the metal box *f* is entirely submerged. On causing the hollow cross to rotate rapidly (by means of an electric motor, for example), water is sucked in at *d* and forced out through *g*. By this means water from the thermostat can be caused to circulate through apparatus and be returned again to the thermostat.

Electrically Heated and Controlled Thermostats.—

When electrical current is available it is not only very convenient, but also, on account of the safety from fire, very advisable to use electricity for the purpose of heating the thermostat, the current being passed through a heating resistance immersed in the water of the thermostat. As heating resistance one can employ either one or more incandescent electric lamps² or an insulated coil of wire. This heating

¹ Obtainable from F. Koehler, Windscheidtstrasse, 33, Leipzig.

² For this purpose one can employ lighting lamps made with a long glass stem so as to allow of the globe being completely immersed in the

resistance is best connected with the main lighting or power circuit.

The heating current is controlled by means of an electromagnetic relay, in conjunction with a thermo-regulator. The ordinary toluene-mercury regulator (Fig. 17), modified as shown in Fig. 24, can be employed. As will be seen from the figure, a platinum wire, *a*, is sealed into the stem of the regulator so as to make contact with the mercury, while a second platinum wire, *b*, is supported in the mouth of the regulator. These two platinum wires are connected with a small battery through the coils of the relay. When the mercury rises in the regulator, contact with the upper platinum wire is made, whereby the electric circuit through the coils of the relay is closed. The end of the beam of the relay is attracted and the heating circuit broken at the mercury cup *c* (Fig. 25). When the bath cools down, the contact between the mercury of the regulator and the upper platinum wire, and consequently the current through the coils of the relay, is broken; the beam of the relay is then pulled down by a spring and contact again made at the cup *c*, whereby the heating circuit is again closed.

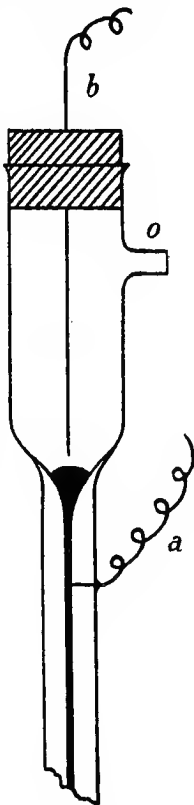

FIG. 24.

water of the thermostat, or the ordinary lamp and holder can be used, provided the latter is suitably protected from the water. Instead of the lighting lamps one may preferably employ a long-globed lamp such as is used for electric radiators.

In order that this apparatus shall work satisfactorily over a lengthened period of time, the platinum-mercury contacts must be kept clean; sparking at these points must therefore be prevented. This can be done very easily by inserting a condenser A, consisting of two aluminium plates immersed in soapy water, across the spark-gaps. It is an advantage also to keep

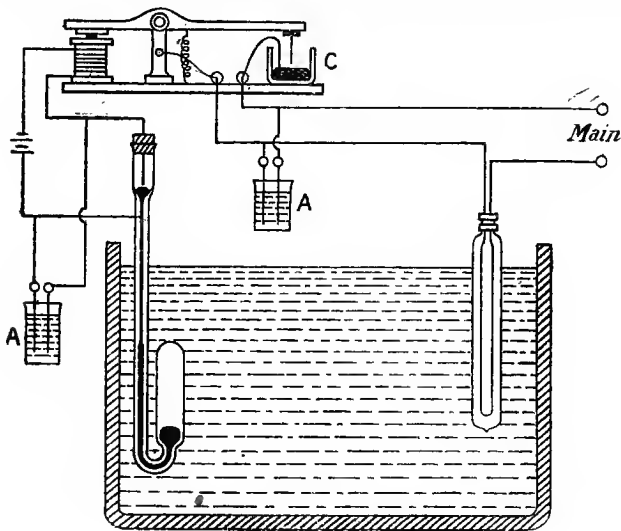

FIG. 25.

the mercury of the regulator in a state of tremor, so as to prevent sticking between the mercury and the platinum. Sufficient tremor can generally be obtained by attaching both stirrer and regulator to the side of the thermostat.

Fig. 25 gives a diagrammatic representation of the arrangement.

References.—Lowty, *Trans. Chem. Soc.*, 1905, 87, 1030; Marshall, *Trans. Faraday Soc.*, 1912, 7, 249; Cumming, *ibid.*, 253; Derby and Marden, *J. Amer. Chem. Soc.*, 1913, 35, 1767.

CHAPTER V

VISCOSITY AND SURFACE TENSION

A.—VISCOSITY

WHEN a liquid flows through a narrow tube, the velocity of flow will depend, in the first place, on the force which produces the flow. All parts of the liquid, however, do not move through the tube with the same velocity, but the layers next the sides of the tube move more slowly than the middle layers. There is thus a shearing, or a movement of the different layers past one another in the direction of flow; and this displacement of the different layers relatively to one another is opposed by the internal friction or *viscosity* of the liquid. We can, therefore, regard the liquid as made up of a number of concentric tubes sliding past one another like the tubes of a telescope.

When the liquid is moving through the narrow tube, there will be a constant difference in velocity between the different tubes of which we have regarded the cylinder of liquid made up, and it has been found that the force per unit area which is necessary to maintain this condition is proportional to the difference of velocity, v , of two adjacent tubes (or their relative velocity of displacement), and inversely proportional to their distance, x , apart, *i.e.*—

$$\text{Force} = \eta \times \frac{v}{x}$$

where η is a constant known as the *coefficient of viscosity*. When the velocity of displacement of two layers is equal to the distance between the layers ($v = x$), the force per unit area becomes equal to the coefficient of viscosity. This gives the definition of the latter quantity.

For the flow of a homogeneous liquid through a capillary tube, the expression has been deduced—

$$\eta = \frac{\pi p r^4 t}{8 V l}$$

where p is the driving force, r is the radius of the tube, t is the time required for the volume, V , of liquid to flow through the tube of length l . This formula holds strictly, however, only when the velocity of the liquid on leaving the tube is zero; and when this is not the case, a correction for the kinetic energy of the liquid must be introduced. It is, therefore, better in practice to use an apparatus of such a form that the value of this correction is reduced to such an extent as to be

negligible. For our present purpose no account need be taken of it.

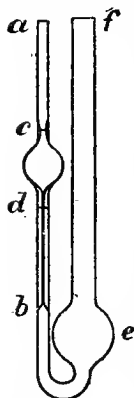

FIG. 26.

The apparatus now generally employed for the determination of the viscosity of liquids, is the Ostwald modification of Poiseuille's apparatus, shown in Fig. 26. It consists of a fine capillary tube db (about 10 cm. long and 0.4 mm. bore), through which a definite volume of liquid—namely, that contained between the two marks c and d —is allowed to flow under the force of its own weight. A definite volume of liquid is introduced into the larger bulb e through the tube f , by means of an accurately calibrated pipette (see p. 32), and is then, either by blowing through f or by sucking at a , forced up

through the capillary until the level of the liquid rises above

the upper mark c . The liquid is then allowed to flow back through the capillary, and the time required for the surface of the liquid to pass from the mark c to the mark d is noted.

The force driving the liquid through the capillary is equal to $h \times s_1 \times g$, where h is the mean difference of level of the liquid in the two limbs of the tube, s_1 is the density of the liquid, and g is the acceleration of gravity. If, now, the *same volume* of a second liquid is introduced into the tube, the mean difference of level of the two liquid surfaces will also be h , so that the driving force is now $h \times s_2 \times g$; or the driving force is proportional to the densities of the two liquids. But we have already seen that the viscosity, η , is equal to $\frac{\pi r^4}{8Vl} \cdot p t$; *i.e.* for a given apparatus and the same volume, V , of liquid, η is proportional to the driving force and to the time of outflow. Hence—

$$\frac{\eta_2}{\eta_1} = \frac{h \cdot s_2 \cdot g \cdot t_2}{h \cdot s_1 \cdot g \cdot t_1} = \frac{s_2 t_2}{s_1 t_1}$$

This expression gives the viscosity of the second liquid relatively to that of the first. For many purposes only the relative viscosity of a liquid is required, and as comparison viscosity that of water at some particular temperature, either 0° or 25° , is generally chosen. It is, of course, easy to obtain the coefficient of viscosity of a liquid in absolute units, by substituting in the above equation the value in absolute units of η_1 , the coefficient of viscosity of the comparison liquid. †

Before being used, the viscosity tube must be thoroughly cleaned, so that there are no obstructions in the capillary, and the liquid must run clean from the glass without leaving drops behind. To secure this, the tube should be kept filled for some hours with a warm solution of chromic acid (sulphuric acid and potassium bichromate), and then thoroughly washed with distilled water, which may be drawn through the tube with

the aid of a filter pump. The tube is then dried by heating in a steam oven, and drawing air, filtered through cotton-wool, through the tube; or it may be washed with alcohol and ether, and the latter removed by a current of air.

As the viscosity of a liquid varies greatly with the temperature (roughly 2 per cent. per degree), the tube and liquid must be kept at a constant temperature during the measurement. The tube is therefore suspended in a bath, the temperature of which can be regulated to within 0.1° . As it is necessary to watch the flow of liquid, the thermostat must be transparent, or have transparent sides. We may therefore use a large beaker fitted with a thermo-regulator (p. 72) and stirrer, preferably a turbine or tube stirrer (p. 77); or a metal bath with transparent sides (p. 69). The viscosity tube must be supported in a perpendicular position, and should be so far immersed in the liquid of the thermostat that the upper mark c is well beneath the surface. As a support for the tube, one may employ either an ordinary retort clamp, or a special clamp attached to the side of the thermostat. A simple holder for the tube can also be made as follows:—

A loop, just large enough to allow the narrower limb of the viscosity tube to pass through, is made on two pieces of fairly thick copper wire, and these are then bound tightly round a small wooden block, so that the one loop is perpendicularly above the other (Fig. 27). The wooden block is then cemented

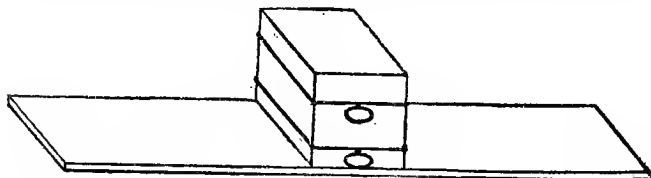

FIG. 27.

to a bar of plate glass or metal, which can be laid across the

top of the thermostat. The viscosity tube is supported in position by passing the end of the narrower limb through the wire loops, and then slipping a rubber band (cut from a piece of tubing of proper size) over it, so that the rubber ring rests on the upper wire loop. If necessary, the tube may be slightly weighted by hooking a strip of lead into the bend of the viscosity tube.

For determining the time of outflow, a stop-watch, reading direct to 0.2 second, should be used.

EXPERIMENT.—*Determine the Relative Viscosity of Benzene, and the Influence of Temperature on the Viscosity.*

Set up a transparent thermostat and stirrer, and adjust the temperature to 25.0° (p. 71). Having thoroughly cleaned a viscosity tube, introduce into the larger bulb *c*, by means of a calibrated pipette, a volume of water, recently boiled and allowed to cool, sufficient to fill the bend of the tube and half, or rather more than half, of the bulb *c*. Fix the viscosity tube in the thermostat, and after allowing 10–15 minutes for the temperature of the tube and water to become constant, attach a piece of india-rubber tubing to the narrower limb of the viscosity tube, and suck up the water to above the mark *c*. Then allow the water to flow back through the capillary, and determine the time of outflow by starting the stop-watch as the meniscus passes the upper mark *c*, and stopping it as the meniscus passes the lower mark *d*. Repeat the measurement four or five times, and take the mean of the determinations. If the time of outflow is about 100 seconds, the different readings should not deviate from the mean by more than 0.1–0.3 second. Greater deviations point to the capillary tube being dirty.

The viscosity tube and pipette must now be dried, and an equal volume of pure benzene introduced into the tube in place of the water. Readings of the time of outflow are then made as in the case of water. The density of benzene at 25°

compared with that of water at 25° (see p. 43) is then determined, and the viscosity of benzene, relative to that of water at 25°, is calculated by means of the formula—

$$\eta_{(\text{benzene})} = \frac{(\text{time} \times \text{density})_{\text{benzene}}}{(\text{time} \times \text{density})_{\text{water}}}$$

To determine the influence of temperature on the viscosity, the time of outflow and the density (compared with that of water at 25°) should be determined at intervals of 5° between the temperatures of 25° and 50°. The values are then plotted on squared paper, and the value of the temperature coefficient $\frac{\Delta\eta}{\Delta t}$ for each range of 5° calculated.

Exercise.—Taking the value in absolute (C.G.S.) units of the viscosity coefficient of water at 25° as equal to 8.95×10^{-8} , calculate the value of the viscosity coefficient of benzene at 10°, 20°, 30°, 40°, 50°; the values of the relative viscosity to be read from the smoothed curve obtained in the preceding experiment. Compare the results with the following values:—

VISCOSITY COEFFICIENT OF BENZENE IN ABSOLUTE UNITS

Temperature.	$\eta \times 10^3$
10°	7.59
20°	6.49
30°	5.62
40°	4.92
50°	4.37

The errors should not exceed 1 per cent.

For table of viscosities, see Appendix.

B.—SURFACE TENSION

Several methods have been devised for determining the surface tension of liquids; one of the most important of these being the determination of the height to which the liquid rises in a capillary tube.

If we denote the value of the surface tension by γ , and by h the height in centimetres, to which a liquid of density s rises in a tube of radius r cm., we obtain the expression—

$$\gamma = \frac{1}{2} \cdot h \cdot r \cdot s \cdot g$$

where g is the value of gravity (981 dynes)¹. We thus obtain the value of the surface tension in absolute units (dynes per cm.).

The value of γ is dependent on the nature of the liquid and also on the temperature; rise of temperature being accompanied by a decrease of the surface tension.

Suppose a gram molecule of a liquid suspended in a medium of the same density so that it is withdrawn from the action of gravity. The liquid will assume a spherical form, and the surface of the sphere may be called the molecular surface. Since any given area on the molecular surface of different liquids will contain the same number of molecules, the product of surface tension and the molecular surface of different liquids should be comparable quantities.

Since the *volumes* of different spheres vary as the cubes and the *surfaces* as the squares of the radii, it follows that the molecular surfaces are proportional to $V^{\frac{2}{3}}$, where V is the molecular volume, or volume of 1 gm. molecule. Multiplying this quantity by the surface tension, we obtain $\gamma V^{\frac{2}{3}}$ or $\gamma(Mv)^{\frac{2}{3}}$, where M is the molecular weight and v is the specific volume. This expression $\gamma(Mv)^{\frac{2}{3}}$ is called the *molecular surface energy*.

The molecular surface energy is a linear function of the temperature; that is to say, the difference of molecular surface energy at two temperatures, divided by the difference of temperature, is constant. Moreover, the numerical value of this constant is approximately the same for different liquids (with certain exceptions), viz. 2.12 when γ is measured in absolute units. For different liquids, therefore, we have the expression—

¹ It is assumed here that the angle of contact between the liquid and glass is zero.

$$\frac{\gamma_1(Mv_1)^{\frac{2}{3}} - \gamma_2(Mv_2)^{\frac{2}{3}}}{t_2 - t_1} = 2.12$$

The molecular surface energy is therefore a *colligative property*, and can be used for the determination of molecular weights. In this way it has been found that in the case of a number of liquids, more especially liquids containing the hydroxyl group, the value of the above expression, when calculated by means of the normal value of the molecular weight, is less than 2.12; and in order to obtain the latter value, it is necessary to multiply the normal molecular weight of the substance by a factor x greater than unity. This factor is called the *association factor*, and gives the number of times the mean molecular weight of the liquid is greater than the normal molecular weight.

Apparatus.—For the purpose of the following experiments the simple apparatus shown in Fig. 28 may be employed. The capillary tube (diameter of bore about 0.4 mm.) passes through a cork fixed in the neck of the wide tube (a Beckmann freezing-point tube serves admirably), in which the liquid to be investigated is placed. On the capillary tube a millimetre scale is etched; or a millimetre scale ruled on glass or opal is attached by means of fine platinum or nickel wire to the capillary tube. The height to which the liquid rises in the capillary tube is then read off by means of a reading lens or a telescope, placed at a convenient distance.

EXPERIMENT.—*Determine the Radius of the Capillary Tube.*

The radius of the bore of the capillary tube can be most conveniently determined by measuring the rise of a standard liquid, *e.g.* benzene, in the tube at a given temperature.

Fit up a thermostat with transparent sides (p. 69), or a large beaker, and regulate the temperature to 0.1° in the neighbourhood of 20°. Thoroughly clean the capillary tube with chromic acid mixture, wash well with distilled water, then with

redistilled methylated spirit, and lastly wash out once or twice with pure benzene. Place a quantity of pure benzene in the outer tube (Fig. 28), and fix the cork carrying the capillary tube in its place; the capillary, however, being drawn so far through the cork that the lower end does not dip into the benzene. Support the tubes in a perpendicular position in the thermostat, and, after the benzene has taken the temperature of the bath, lower the capillary and scale so as to dip beneath the surface of the benzene. By means of a tube passing through a cork in the side tube, cause the benzene to pass up and down the capillary, so that the walls of the latter may become completely wetted. By means of a telescope placed at a convenient distance, read the position on the scale of the benzene meniscus in the wider tube and in the capillary. Three or four readings should be made, both after the benzene has been made to rise above (by blowing through C), and made to fall below (by sucking through C), its final position. The different readings should not differ from the mean value by more than ± 0.2 mm. from one another. Greater deviations point to the capillary tube being dirty.

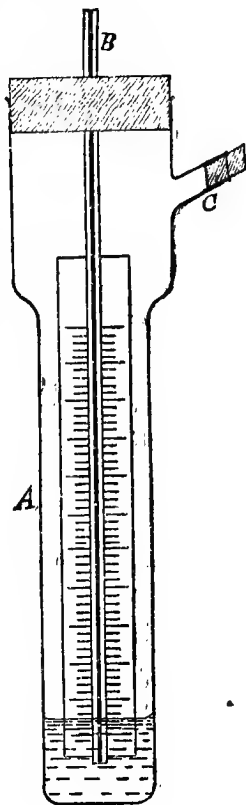

FIG. 28.

Having determined the rise of liquid at 20° , repeat the determination at, say, 40° ; the temperature being again kept constant to within 0.1° . As the rise will in this case not be so

great as in the former case, the capillary must be lowered further into the benzene, in order that the meniscus in the capillary shall stand at the same point as before. If necessary, a further quantity of benzene should be poured into the outer tube.

From these two determinations of the rise of benzene, the radius of the capillary at the point at which the meniscus stood can be calculated from the equation $\gamma = \frac{1}{2} \cdot h \cdot r \cdot s \cdot g$, provided that we know the value of γ and of s , at the temperatures of the determinations. These can be obtained by plotting the following values of γ and of s for benzene, and reading off the values at the appropriate temperatures from the curves.

SURFACE TENSION AND DENSITY OF BENZENE

Temperature.	γ	s
10·0°	29·36	0·8885
46·2°	24·67	0·8499
78·2°	20·68	0·8147

The mean of the values obtained at the two temperatures may be taken as the true value of the radius.

EXPERIMENT.—*Determine the Molecular Surface Energy and the Association Factor of Ethyl Alcohol.*

Having thoroughly cleaned the outer tube and capillary (the latter should be washed out once or twice with pure alcohol before use), the apparatus is again fitted together and fixed in the thermostat, which should be regulated for a temperature of about 20°. The amount of alcohol placed in the outer tube should be so regulated that the meniscus in the capillary stands at the same point as in the case of benzene. The capillary rise is determined in the same way as before; several readings being taken both with falling and with rising meniscus.

A similar set of readings should be taken at a higher temperature, say about 40° .

The density of the alcohol at the same temperatures as above must also be determined (p. 43).

From the value of the capillary rise, the density, and the radius of the capillary as determined in the preceding experiment, the value of the surface tension at each temperature can be calculated. Compare the results with the values obtained by plotting the following values:—

SURFACE TENSION OF ALCOHOL

Temperature.	γ
$10^{\circ}0$	22.91
$20^{\circ}0$	22.03
$40^{\circ}0$	20.20
$60^{\circ}0$	18.43

An error of 0.5 per cent. may be allowed in the values of the surface tension.

From the values of the surface tension at the two temperatures, calculate the value of the molecular surface energy at each temperature, and also the mean value of the temperature coefficient between the two temperatures of experiment. From the value of the coefficient (k) so found, calculate the association factor α by means of the expression $\alpha = \left(\frac{2.12}{k}\right)^{\frac{1}{2}}$.

Drop Method.—The value of the surface tension can also be obtained by determining the weight of the drop of liquid which falls freely from the end of a tube. If it is again assumed that the angle of contact between the liquid and the tube is zero (which is, however, in general, not strictly correct), we have $2\pi r \cdot \gamma = W = v \cdot d$, where $2\pi r$ represents the external circumference of the end of the tube; W , the weight of the

drop; v , its volume; and d , the density (specific gravity). For relative determinations it is easier, instead of determining the weight of the drops, to determine the *number* of drops formed

by a given volume of the liquids. If one employs the same dropping tube, then, since the number of drops yielded by the same volume of liquid is inversely proportional to the volume of a single drop, we have

$$\frac{\gamma_1}{\gamma_2} = \frac{v_1 d_1}{v_2 d_2} = \frac{n_2 d_1}{n_1 d_2}$$

where γ_1 and γ_2 are the surface tensions of the two liquids; and n_1 and n_2 are the number of drops given by the same volume of the liquids, the densities of which are d_1 and d_2 respectively. If the surface tension of one of the liquids is known, that of the other can be calculated.

Traube's Stalagmometer.—For the determination of the surface tension by the drop method, the Traube stalagmometer is convenient and accurate. A diagram of the apparatus is shown in Fig. 29. The dropping-tube or stalagmometer, A, consists of a capillary tube the end of which is flattened out (in order to give a larger dropping surface) and the surface is then carefully ground flat and polished. The capillary

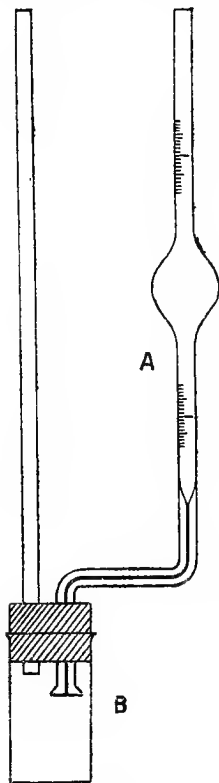

FIG. 29.

is sealed on to a wider tube on which a bulb is blown, and on the stem of the tube two marks are etched, one above and one below the bulb. The determination of the surface tension

then consists in counting the number of drops which fall from the end of the stalagmometer while the level of the liquid falls from the upper to the lower mark. To increase the accuracy of the readings, the tube above and below the bulb is marked with a scale. With the help of this, fractions of a drop can be estimated, with an accuracy of 0.05 of a drop, by first determining how many scale divisions correspond to *one* drop. While making this preliminary determination the flow of liquid from the stalagmometer may be retarded, if necessary, by placing the finger lightly on the open end of the tube.

Great care must be exercised to ensure that the dropping surface is perfectly free from greasiness. It must be carefully cleaned by means of chromic acid mixture, and polished, when necessary, by means of a piece of fine soft linen or clean cotton wool. Even slight traces of grease on the dropping surface will markedly alter the size of the drops formed. Care should also be taken to preserve the apparatus from being shaken while an experiment is being carried out, as thereby the drops of liquid may be caused to fall before they have attained their maximum size. For the same reason the velocity of flow of the liquid must be regulated so that the drops are not formed too rapidly; and although the rate of dropping may be varied, up to a certain point, without affecting the size of the drop, it should not be allowed to increase above a maximum of 20 drops per minute. If the natural rate of dropping is greater, it must be retarded, either by placing the finger lightly on the upper end of the tube, or, better, by attaching to the latter a piece of fine thermometer capillary tubing of greater or shorter length according to the rate of dropping.

For determinations with liquids of greatly different viscosity, and, consequently, different rate of dropping, one may also use stalagmometers with capillary tubes of different bore.

In order that the determinations may be carried out at constant temperature, the end of the stalagmometer is passed

through a rubber stopper which fits into the neck of a small tube or bottle B (Fig. 29). The apparatus may then be placed in a thermostat.

EXPERIMENT.—*Determine the Surface Tension of Benzene and Ethyl Alcohol at 25°.*

The drop-number for water is first determined. The stalagmometer, having been cleaned, is filled with distilled water, and then, with the lower end protected by a tube as shown in Fig. 29, immersed in a thermostat at 25°. As explained above, the number of scale divisions corresponding to one drop is determined, and then the number of drops contained in the volume of liquid between the two fixed marks. Different determinations of this number should not vary by more than 0.3–0.5 drop.

The stalagmometer is then dried and determinations of the drop-number for benzene and for alcohol carried out in exactly the same way. From the values of the drop-numbers and densities of the liquids, and the value of the surface tension of water at 25°, the surface tensions of benzene and alcohol can then be calculated. (See Table IV., Appendix.)

The values of the surface tension determined by this method and by the capillary-rise method, should not differ by more than 1 per cent.

References.—VISCOSITY. Dunstan and Thole, *Viscosity of Liquids* (Longmans); Scarpa, *Gazzetta*, 1910, 40, 271; Washburn and Williams, *J. Amer. Chem. Soc.*, 1913, 35, 739.

SURFACE TENSION.—Renard and Guye, *J. Chim. Phys.*, 1907, 5, 81; Traube, *Ber.*, 1887, 20, 2644, 2824; *J. pr. Chem.*, 1886, (2), 34, 292; Morgan, *J. Amer. Chem. Soc.*, 1911, 33, 349, or *Zeitschr. physikal. Chem.*, 1911, 77, 339.

CHAPTER VI

OPTICAL MEASUREMENTS

A.—REFRACTOMETRIC MEASUREMENTS

Refractive Index.—When a ray of monochromatic light passes from a less dense to a more dense medium, it is bent or refracted towards the normal. Thus, in Fig. 30, if I is the less dense and II the more dense medium, a ray of light passing from I to II will be bent so that the angle of refraction e will be less than the angle of incidence i ; and, according to the law of refraction, the relation between these two angles will be such that—

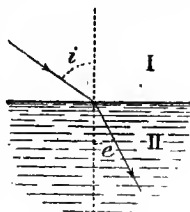

FIG. 30.

$$\frac{\sin i}{\sin e} = \frac{N}{n}$$

where n is the index of refraction of the less dense, and N the index of refraction of the more dense medium. As the angle i increases, the angle e also increases, and reaches its maximum value when i becomes equal to a right angle; that is, when the incident light is horizontal. Since $\sin 90^\circ = 1$, the above equation becomes $\frac{1}{\sin e} = \frac{N}{n}$, or $\sin e = \frac{n}{N}$.

Determination of the Refractive Index of a Liquid.

—The method which we shall employ for the determination of the refractive index of a liquid, is based on the law of refraction

just stated. The liquid, the refractive index of which is to be determined, is placed in a cell cemented to the top of a right-angled glass prism (Fig. 31),

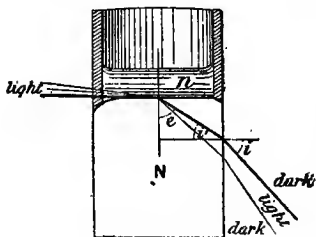

FIG. 31.

the refractive index of which must be known, and must be greater than that of the liquid. A beam of monochromatic light entering the liquid will be refracted through the prism in the manner shown in the figure. If we consider the path of the last ray to enter the prism,

namely, the horizontal ray (represented by the thick line), then

$\sin e = \frac{n}{N}$, where n is the index of refraction of the liquid, and N that of the glass (referred to that of air equal to unity).

Further, $\frac{\sin i}{\sin i'} = N$. But $\sin e = \cos i'$, and, therefore, $n = N \cos i'$. But $\cos^2 i' = 1 - \sin^2 i'$; hence, $n = N \sqrt{1 - \sin^2 i'}$.

Substituting for $\sin^2 i'$ the value $\frac{\sin^2 i}{N^2}$ we obtain—

$$n = \sqrt{N^2 - \sin^2 i}$$

If, therefore, we know the value of N (the refractive index of the glass), and the angle i at which the light emerges from the prism, the value of n , the refractive index of the liquid, can be calculated. A table of values of $\sqrt{N^2 - \sin^2 i}$ for the particular prism and for different values of i is supplied by the makers.

Specific and Molecular Refractivity.—Whereas the refractive index of a substance varies with the temperature, it has been found (Gladstone and Dale) that the expression

$\frac{n - 1}{d}$, where d is the density, remains nearly constant at

different temperatures. Still more is this the case with the expression $\frac{n^2 - 1}{n^2 + 2} \cdot \frac{1}{d}$ (Lorentz and Lorenz). The value of these expressions is, therefore, dependent only on the nature of the substance, and is a characteristic of it. It is called the *specific refractive power* or *refractivity* of the substance. If the value of the refractivity is multiplied by the molecular weight of the substance, we obtain the *molecular refractivity*. The latter is, therefore, equal to $\frac{M(n - 1)}{d}$, or $\frac{n^2 - 1}{n^2 + 2} \cdot \frac{M}{d}$, where M is the molecular weight.

Monochromatic Light.—Since the value of the refractive index varies with the wave-length of the light, it is necessary, in carrying out these measurements, to employ monochromatic light of definite wave-length. The lines of the spectrum for which one generally determines the refractive index, are the D line (given by the sodium flame), the C line (red line of the hydrogen spectrum), and the G line (violet line of the hydrogen spectrum¹).

Sodium light can be easily obtained by heating a salt of the metal, such as the chloride, bromide, nitrate, or borate, in a Bunsen flame. The bromide gives a more intense light than the chloride, but can be used only under a draught hood on account of the evolution of bromine fumes.

The salt may be supported in a Bunsen flame by means of a platinum wire or piece of platinum gauze, or it may be placed in a low heap round a circular opening cut in a sheet of asbestos board. The opening should be of such a size that the flame just passes through, and the asbestos should be supported at such a height that only about one-third of the flame is below the asbestos. The flame should also be protected

¹ If mercury is present in the vacuum tube, three violet lines may be seen, one of which belongs to mercury. The G' line is the one of intermediate wave-length. The lines C, F, and G' (red, blue, and violet) lines of the hydrogen spectrum are also referred to as H_α, H_β, H_γ. Line G' is identical with the Fraunhofer line f, and has a wave-length λ = 434·1 μμ.

from draughts by almost completely surrounding it by a cylinder of tin-plate, or other material.

Another simple method of obtaining a bright sodium flame is to place a few beads of fused sodium chloride on the grid at the top of a Méker burner. In this case, also, the flame should be protected from draughts.

To obtain light corresponding with the C and G lines, one employs a Geissler tube filled with hydrogen under low pressure, and worked by an induction coil. In order to obtain stronger illumination, it is best to use an end-on tube (Fig. 32).

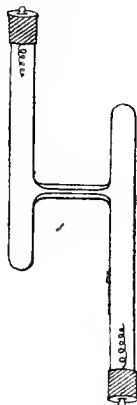

FIG. 32.

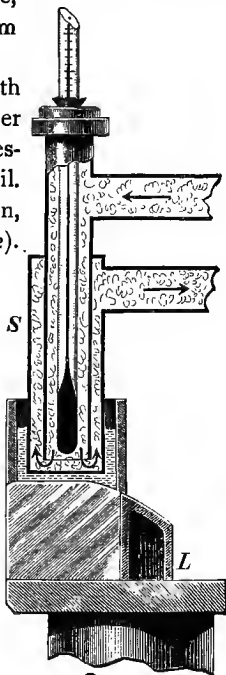

FIG. 33.

Regulation of the Temperature.—As the density, both of the prism and of the liquid under investigation, alters with temperature, it is necessary, in measurements of any considerable degree of accuracy, to be able to maintain the prism and the liquid at constant temperature. In the newer form of Pulfrich refractometer, made by Zeiss, to be described below,

this is effected by means of the arrangement shown in Fig. 33. The prism is surrounded by a metal box, L, through which water circulates. After passing round the prism, the water is led, by means of an india-rubber tube, into the heating tube S, which is lowered into the liquid in the cell, and then passes to the waste. A thermometer screwed into the heating tube S shows the temperature of the circulating water, and must be fixed in position before water is passed through the heater.

Pulfrich Refractometer.—The Pulfrich refractometer (as made by Zeiss) is shown in Fig. 34, the instrument being viewed from behind in order to show the optical parts. This instrument is arranged for illumination either by a coloured flame or by means of a Geissler tube (Q).

Place the refractometer on a table sufficiently broad to allow of a sodium flame being placed about 20 inches away from it, and opposite to the reflecting prism N, which is arranged to swing outwards or inwards. The refracting prism (L), carrying its glass cell,¹ is first of all placed in position on the triangular standard; the prism being allowed to sink as far as it will go, and then fixed by means of the screw K.² The flat face of the prism must, of course, point towards the telescope tube F. The india-rubber tube attached to the heater (at R) is placed in position over the conical connecting piece in the side of the prism case, and the thermometer screwed

¹ The glass cell may be cemented to the prism by means of fish-glue or seccotine, the cement being applied in a thin uniform layer to the edge of the glass cylinder. This is facilitated by means of a glass block, the surface of which is ground so as to have the same curvature as that of the edge of the cylinder. The cement is first rubbed on the surface of the block, and the edge of the cylinder then placed on the block and carefully turned round so as to apply a thin coating of cement.

When the temperature of the experiment is not high, the cell may frequently be attached to the cylinder by means of vaseline. In this case, however, it is very easily displaced.

² In this, as in all such cases, only a very gentle pressure must be exercised in tightening the screw.

into the top of the heater. Water from a thermostat can then be caused to circulate round the prism and through the

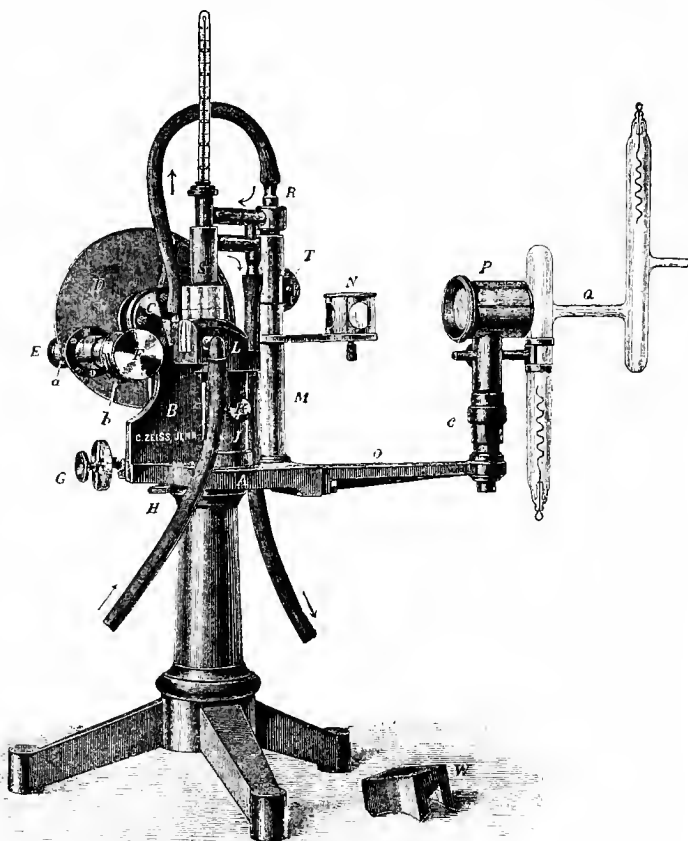

FIG. 34.

heater (S), the water being passed in at L, and allowed to run to the waste through the tube connected with the heater.

The light, after refraction through the prism, passes into the telescope tube through an elongated oblong slit in the cap F. This can be rotated through a certain angle, but there are four points at which it is fixed by stops, the action of which will be felt on rotating the cap. In one position the whole of the oblong slit is open to the prism, in two other positions only half the slit is open, while in the fourth position the aperture is closed altogether. The half-slits are used only when observations are being made with a divided cell; when a single cell is used, the whole slit must be open.

On examining the face of the disc D, to which the telescope is attached, it will be seen that it is graduated over a quarter of its circumference into degrees and half-degrees ($30'$); and there is a vernier with thirty divisions, by means of which single minutes can be read. The reading of the vernier is facilitated by a small lens, which can be moved in front of the scale. For the purpose of making fine adjustments, the disc is fixed by means of the screw H, and the fine adjustment made by means of the screw G.

When it is desired to use a Geissler tube as the source of illumination, the latter (Q) is clamped to the standard ϵ , so that the end of the capillary is opposite the middle of the lens P, whereby the light is focussed on the cell.¹

Determination of the Zero Point.—Before proceeding to make a measurement, the correction for zero, if any, must

¹ In more recent forms of the apparatus, the upright standard is replaced by a curved arm carrying both the lens P and the Geissler tube; and this arm can be moved upwards or downwards so that the angle at which the light enters the cell can be altered slightly. In this way, one can correct for slight displacements of the cell-walls from the perpendicular, and also their want of parallelism with the face of the prism, and so obtain sharper and clearer lines. This newer form of attachment also is furnished with a screw which allows of the Geissler tube being moved laterally; and with a metal diaphragm which allows one to cut off some of the light passing through the lens, and so sharpen the spectrum lines in the field of view.

first be ascertained. This is done with the help of a small right-angled prism, a , let into the side of the telescope tube near the eye-piece. The disc is first of all

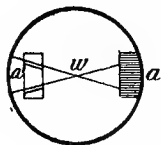

FIG. 35.

rotated until its zero coincides approximately with the zero of the vernier, and is fixed in this position by means of the screw H. A source of illumination (best, an electric lamp) is then fixed opposite to the prism a . On looking through the eye-piece of the telescope, the field of view will have the appearance shown in Fig. 35. To the right is seen the prism a , while to the left of the field of view is seen a bright rectangular patch, a' , crossed by two lines running parallel with the cross-wires w . This bright patch is the image of the prism a reflected from the face of the refracting prism (L), and the two marks are the images of the cross-wires. The zero of the instrument is given when the cross-wires w coincide with their images. The adjustment to coincidence is carried out by means of the fine adjustment screw G, and the point on the scale opposite to the zero of the vernier is then read. This is the zero of the instrument, and the difference of this reading from the zero mark is the correction which has to be applied to each subsequent reading of the scale.

It happens, however, not infrequently that the prism L is slightly turned in its bed, so that the image of the prism and cross-wires is thrown either nearer to or farther from the centre of the field of view. In this case, simultaneous coincidence of both the cross-wires with their images cannot be obtained. The zero is, in such a case, determined by setting the upper cross-wire in coincidence with the upper image, then the lower cross-wire in coincidence with the lower image, and taking the mean of the two readings.

Having ascertained the zero correction, we may now proceed to make measurements of the refractive index.

EXPERIMENT.—*Determine the Refractive Index of Acetone for the D Line.*

The refractometer is set up as described above, a sodium flame being used as source of illumination. This flame is placed at a distance of 18 to 20 inches from the reflecting prism N, which must be swung into position so as to throw an image of the flame on the side of the cell on the top of the prism L. (The arm carrying the reflecting prism should be swung as far as it will go towards the back of the instrument.) In order to exclude extraneous light, and also to diminish fluctuations of temperature, a black wooden cap, W (Fig. 34), is placed over the cell. In one side of this cap a notch is cut, through which the light enters into the liquid in the cell.

Place a small quantity of acetone in the cell so as to form a layer about 4 mm. deep. Swing the heating tubes into place, and lower the heater S (the outside of which must be quite clean) into the cell by means of the milled head T (Fig. 34); a stop prevents the heater from being lowered too far. Lower the movable flange on the heater until it is in contact with the top of the cell. Circulate water from a thermostat (p. 79) round the prism and through the heater, the temperature of the water being regulated to a temperature of, say 25°. Make sure that the acetone does not evaporate entirely in the course of the measurements.

When the temperature has become constant (within 0.1°), loosen the screw H, and rotate the disc until the refracted beam of light is visible, forming a band of yellow light across the field of view. Fix the disc, and then, by means of G, place the intersection of the cross-wires on the upper sharp edge of the yellow band, the cross-wires having first been focussed sharply by rotating the eye-piece.

Make several determinations of the point of coincidence, and take the mean as the correct value. The individual readings should not differ from the mean by more than one minute.

Having in this way determined the angle of emergence, the index of refraction can be obtained from the tables supplied by the makers of the instrument.

To illustrate the use of the table, the following example may be taken :—

Suppose the angle of emergence to be $64^{\circ} 45'$. On looking up the tables for the particular prism (Ia), we find the following numbers—

<i>i</i>	n_D	Δ_n	Correction values for—		
			C	F	G'
$64^{\circ} 30'$	1.34647		588	1475	2729
40'	564	8.3	8	6	31
50'	480	8.4	9	7	3
$65^{\circ} 0'$	1.34397	8.3	589	1478	2735

Under the heading *i* are the angles of emergence read; under n_D , the refractive index of the liquid, calculated according to the equation $n = \sqrt{N^2 - \sin^2 i}$. The numbers under Δ_n are the differences in units of the last decimal place of the value of the refractive index for a difference of r' in the value of the angle of emergence. The three last columns of the table will be explained later.

The angle of emergence with sodium light (D line of sun's spectrum) we have supposed to be $64^{\circ} 45'$. The value of n_D for $64^{\circ} 40'$ is 1.34564, and the difference in the value of n for r' is 8.4; so that the value of n_D for the angle $64^{\circ} 45'$ will be $1.34564 - 0.00042 = 1.34522$.

Having obtained the value of the refractive index from the tables, and the density of the liquid at the temperature of the experiment having been determined (p. 43), the specific and molecular refractivities can be calculated by means of the formulæ—

$$R^{(2)} = \frac{n^2 - 1}{n^2 + 2} \cdot \frac{1}{d}, \quad \text{and} \quad MR^{(2)} = \frac{n^2 - 1}{n^2 + 2} \cdot \frac{M}{d}$$

$R^{(2)}$ here represents the refractivity calculated according to the formula of Lorentz and Lorenz, involving the square of the refractive index, in order to distinguish it from $R^{(1)}$, the refractivity according to the formula of Gladstone and Dale, $\frac{n - 1}{d}$.

The value of $MR^{(2)}$ obtained, should be compared with the value calculated from the sum of the atomic refractivities. Some of these values, for the spectrum lines C, D, G', are given in the following table:—

VALUES OF ATOMIC REFRACTIVITIES FOR SOME OF THE ELEMENTS, CALCULATED ACCORDING TO THE $R^{(2)}$ FORMULA

Element.	Symbol.	r_C	r_D	r_F	r_G
Carbon (singly bound)	C'	2'413	2'418	2'438	2'466
Hydrogen	H	1'092	1'100	1'115	1'122
Oxygen (in OH group)	O'	1'522	1'525	1'531	1'541
" (in ethers)	O <	1'639	1'643	1'649	1'662
" (in CO group)	O''	2'189	2'211	2'247	2'267
Chlorine	Cl	5'933	5'967	6'043	6'101
Bromine	Br	8'803	8'865	8'999	9'152
Iodine	I	13'757	13'900	14'224	14'521
Ethylene bond		1'686	1'733	1'824	1'893
Acetylene ,,		2'328	2'398	2'506	2'538

In the above table—

- r_C denotes the atomic refractivity for the C (or H_α) line (red) of the hydrogen spectrum ;
 r_D denotes the atomic refractivity for the D line (sodium light) ;
 r_F " " " " F (or H_β) line (blue) of the hydrogen spectrum ;
 r_G denotes the atomic refractivity for the G' (or H_γ) line (violet) of the hydrogen spectrum.

When a measurement has been completed, as much as possible of the liquid is withdrawn from the cell by means of a pipette, the point of which *must be placed against the lower*

function of cell and prism, and must not be allowed to touch the upper polished surface of the prism, which might thereby be scratched. The last traces of liquid are removed by means of filter paper.

Correction for Temperature.—The values of the refractive index given above (p. 107) refer, strictly, only to the temperature of 20° . When measurements are made at any other temperature, a correction has to be applied. Tables of temperature corrections for the different prisms are issued by the instrument makers. To illustrate the use of the tables, we may take the table for Prism I., supplied by Zeiss with their Pulfrich refractometer :—

TABLE OF TEMPERATURE CORRECTIONS

n	Correction in units of the fifth decimal place of n .		
	C	D	G'
1.60	0.25	0.29	0.52
1.50	0.26	0.30	0.55
1.40	0.28	0.33	0.59
1.30	0.30	0.35	0.64

To make the temperature correction, look up the value of the correction for the different spectrum lines to be applied to values of n of the order given in the first column; multiply this number by the temperature difference ($t - 20$), where t is the temperature at which the measurements were made, and add the result (units of the fifth decimal place) to the value of n taken from the tables.

Thus, suppose a determination to have been carried out at 30° , and the angle $64^{\circ} 30'$ obtained as the angle of emergence, with Prism I. using the D line. From the table on p. 106 we see that $n_D = 1.34647$ at 20° . The value of the correction is, from the preceding table, $0.35 \times (30 - 20) = 3.5$. This must

be added to the fifth place in the above value of n , and we obtain 1.34651.

EXPERIMENT.—*Determine the Refractive Index of Acetone for the C and G' lines of the Hydrogen Spectrum.*

A Geissler hydrogen tube is clamped in position as already described (p. 103), so that the light is focussed at the notch of the wooden cap of the cell, the reflecting prism N (Fig. 34) being pulled forward out of the path of the light. After having placed a quantity of acetone in the cell, the position of the tube must be so adjusted, that on looking through the telescope, the lines appear at their brightest and are most clearly defined. The adjustment is best carried out by first roughly adjusting the position of the tube, while in action, by hand, and then moving the tube and lens upwards or downwards, or the tube sidewise by means of the different adjusting screws, until the best position is obtained. After the lines have been obtained quite clear and bright, they may be narrowed down and sharpened somewhat by means of the movable diaphragm in front of the lens.

The chief lines of the hydrogen spectrum which one sees, are a bright red line on the extreme right (C line), a pale blue line (F line), and, on the extreme left, two violet lines (G' and G''). If, as is frequently the case, a little mercury is placed in the Geissler tubes, one also sees several lines between the C and the F lines, more especially a green line (one of the mercury lines). Measurements are generally confined to the C, F, and G' lines of the hydrogen spectrum.¹

The temperature having been regulated as described on p. 100, the Geissler tube is put in action, and the angle of emergence for the C line determined by bringing the intersection of the cross-wires into coincidence with the upper edge of the red line. After reading the angle on the graduated disc,

¹ Owing to differences in the relative dispersive power of the prism and the liquid, the order of the lines may not be that given above. The measurements and calculations are, however, thereby in no way interfered with.

the latter is turned by means of the fine-adjustment screw G (Fig. 34) until the cross coincides with the upper edge of the violet line, G', when the angle is again read.

Instead of reading the angle of emergence for each line on the scale of the disc, it is only necessary to do so for one of the lines, the position of which is determined accurately. The position of the other lines is then determined by difference by means of the scale on the drum-head of the micrometer screw G. This drum is graduated into 200 parts, and moves in front of a horizontal scale, graduated into divisions corresponding to degrees and thirds of a degree (20'). One complete turn of the micrometer screw causes the drum to advance or retreat across one of the subdivisions of the horizontal scale, and the telescope to move through an angle of 20'. Consequently, as there are 200 divisions on the drum, each of these is equivalent to 0.1'. The use of the graduated drum is especially advantageous for the determination of the angle of dispersion of a substance; and the only precaution that requires to be observed in its use is to turn it always in the same direction when bringing the cross-wires of the telescope into coincidence with the boundary-line of light.

Having obtained the value of the angles of emergence for the C and G' lines, the value of the refractive index is obtained from the tables (p. 106), the numbers in the columns C, F, G' giving the numbers (in units of the fifth decimal place) which must be subtracted from or added to the value of n_D in order to give the value of the refractive index for the other lines. In the case of the C line, the correction value must be subtracted from the value n_D ; in the case of the F and G' lines, the correction value must be added. Thus, suppose the angles read were $64^\circ 30'$ and $65^\circ 0'$ for the C and G' lines respectively, then, from the tables we obtain—

$$n_c = 1.34647 - 0.00588 = 1.34059$$

$$n_g = 1.34397 + 0.02735 = 1.37132$$

From the values of the refractive index, the molecular refractivity for the C and G' lines should be calculated, and also the value of the molecular dispersivity (the difference of the molecular refractivities) between the C and G' lines; and the numbers compared with the sum of the atomic refractivities given on p. 107.

Refractivity of Substances in Solution.—In the case of not too strong solutions, the refractivity of the solute can be determined (with fair approximation, at least¹) from the values of the refractivity of the solution and of the solvent, according to the ordinary mixture formula. Let n_1 , n_2 , and n_3 be the refractive indices of the solute, solvent, and solution respectively, and d_1 , d_2 , d_3 the corresponding densities; then, if the solution contains p per cent. of the solute, we obtain (using the $R^{(1)}$ formula (Gladstone and Dale))—

$$\frac{n_3 - 1}{d_3} = \frac{n_1 - 1}{d_1} \cdot \frac{p}{100} + \frac{n_2 - 1}{d_2} \cdot \frac{100 - p}{100}$$

or—

$$\frac{n_1 - 1}{d_1} = \frac{n_3 - 1}{d_3} \cdot \frac{100}{p} - \frac{n_2 - 1}{d_2} \cdot \frac{100 - p}{p}$$

Or, if we use the $R^{(2)}$ formula—

$$\frac{n_1^2 - 1}{n_1^2 + 2} \cdot \frac{1}{d_1} = \frac{n_3^2 - 1}{(n_3^2 + 2)d_3} \cdot \frac{100}{p} - \frac{n_2^2 - 1}{(n_2^2 + 2)d_2} \cdot \frac{100 - p}{p}$$

EXPERIMENT.—*Determine the Molecular Refractivity of Potassium Chloride.*

Make up a solution of potassium chloride in water (say 10 per cent. by weight), and determine the refractive index first of pure water, and then of the solution, for the D line at a temperature of about 20°. The density of the solution relatively to that of water at 20° equal to 1 must also be determined at the same temperature. From the refractive indices obtained, calculate the specific and molecular refractivity of potassium chloride. Use the Gladstone and Dale formula.

¹ The refractivity varies with the solvent used.

B.—POLARIMETRIC MEASUREMENTS

When ordinary light is passed through a Nicol's prism (made from Iceland spar), the emergent ether vibrations take place in one plane, and the light is said to be plane-polarized. If this polarized light is now examined by means of another Nicol's prism, it will be found that, on rotating the latter, the field of view appears alternately light and dark, the minimum of brightness following the maximum as the prism is rotated through an angle of 90° . The prism by which the light is polarized is called the *polarizer*, and the second prism, by which the light is examined, is called the *analyzer*.

If, when the field of view appears dark (which occurs when the axes of the two prisms are at right angles to each other), a tube containing a solution of cane sugar is placed between the two prisms, the field lights up; and one of the prisms must be turned through a certain angle, α , before the field becomes dark again. The solution of cane sugar has therefore the power of turning or rotating the plane of polarized light through a certain angle, and is hence said to be optically active. When, in order to obtain darkness, the analyzer has to be turned to the right, *i.e.* clockwise, the optically active substance is said to be *dextro-rotary*; and *laevo-rotary* when the analyzer must be turned to the left.

It will, of course, be possible to obtain a position in which the field of view becomes dark by rotation of the analyzer either to the right or the left, because in one complete rotation of the prism through 360° , there are two positions of the analyzer, 180° apart, at which the field is dark, and similarly, two positions at which there is a maximum of brightness. In determining the sign of the activity of a substance, one takes the direction in which the rotation required to give extinction is less than 90° .¹

¹ This, however, is not an universal rule. See Landolt, "Das optische Drehungsvermögen," 2nd. edit., p. 281.

The angle of rotation depends on (1) the nature of the substance, (2) the length of the layer through which the light passes, (3) the wave-length of the light employed (the shorter the wave-length, the greater the angle of rotation), (4) the temperature. In order, therefore, to obtain a measure of the rotary power of a substance, these factors must be taken into account, and we then obtain what is known as the *specific rotation*. This is defined as the angle of rotation produced by a liquid which in the volume of 1 c.c. contains 1 gm. of active substance, when the length of the column through which the light passes is 1 dcm. The specific rotation is represented by $[\alpha]$, the observed angle of rotation being represented simply by α .

When, therefore, we are dealing with an homogeneous active liquid, the specific rotation is represented by—

$$[\alpha] = \frac{\alpha}{l \cdot d}$$

where l is the length of the column of liquid in decimetres, and d is the density. If, further, we take into account the other factors on which the rotation depends, viz. temperature and wave-length of light, we obtain a number which, for the particular conditions of experiment, is a constant, characteristic of the substance. Thus, $[\alpha]_D^{25^\circ}$ represents the specific rotation for the D line (sodium light) at the temperature of 25° .

When the active substance is examined in solution, the concentration must be taken into account, and we obtain—

$$[\alpha] = \frac{100 \cdot \alpha}{l \cdot c} \text{ or } [\alpha] = \frac{100 \cdot \alpha}{l \cdot \rho \cdot d}$$

where c is the number of grams of active substance in 100 c.c. of solution, ρ is the number of grams of active substance in 100 gm. of solution, and d is the density of the solution. In expressing the specific rotation of a substance in solution, the

concentration and the solvent (which also has an influence on the rotation) must also be stated.

Apparatus.—*The Polarimeter.*—Of the various forms of polarimeter which have been invented, only two need be considered here, viz. the Lippich and the Laurent half-shadow polarimeters; and these differ essentially only in the method of producing the half-shadow.

In the case of the Laurent polarimeter, the arrangement of the optical parts is shown diagrammatically in Fig. 36. Monochromatic light from the source L passes through the lens A, which renders the rays of light parallel, and then through the polarizing prism B. It then passes through the observation

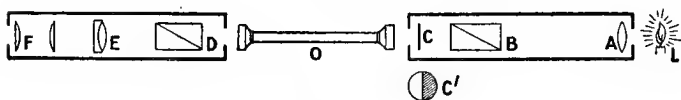

FIG. 36.

tube O, and thence through the analyzer D. The field of view is observed through the telescope EF. At C, the circular opening of the tube carrying the polarizer is half covered by a thin quartz plate (as shown at C'), the thickness of which is chosen such that the light in passing through the plate is altered in phase by half a wave-length,¹ but still remains plane-polarized. In this way, two beams of polarized light are obtained; and if the polarizer is rotated so that the plane of polarization forms an angle (δ) with the quartz plate, the planes of polarization will also be inclined at an angle, equal to 2δ . This is the half-shadow angle. On rotating the analyzer, a position will be found at which the one beam will be completely, the other only partially, extinguished. The one half of the field of view, therefore, will appear dark, while the other half will still remain

¹ The apparatus can therefore be used only with light of one wave-length.

light. On rotating the analyzer still further, through the angle 2δ , a second position will be found at which the second beam will be extinguished, while the first is no longer so. In this position of the analyzer, the half of the field which was formerly bright will now be dark, and that formerly dark will now be light. When, however, the analyzer occupies an intermediate position, the field of view will appear of uniform brightness; and this is the position to which the analyzer must be set.

By diminishing the angle δ (by rotating the polarizer), the sensitiveness of the instrument can be increased, because now the angle 2δ , through which the analyzer must be rotated in order to cause the shadow to pass from one half to the other of the field of view, is diminished. By diminishing the angle of half-shadow, however, the uniform illumination of the field of view is also diminished, so that the increased sensitiveness due to diminution of the angle of half-shadow is partly counteracted by the greater difficulty in deciding when the field is uniformly illuminated, unless the light intensity of the source can at the same time be increased. With a source of light of given intensity, therefore, the angle of the half-shadow must be so fixed that the determination of the position of uniform illumination can be made without unduly straining the eyesight.

The Lippich polarimeter differs from the Laurent form only in the method of producing the half-shadow. Instead of the quartz plate, there is a small Nicol prism which covers half of the opening at the end of the polarizer tube. The effect produced is the same as with the quartz plate, and the apparatus possesses the advantage that it can be used with light of any wave-length.

The complete polarimeter is shown in Fig. 37.

At the end S, which is directed towards the source of light, are the lens and the light-filter, consisting either of a solution of potassium bichromate or of a crystal of this salt. The polarizing prism is at P, and is connected with the lever h_1 by

means of which it can be rotated, and thus the angle of half shadow altered. The observation tube is placed in the middle part of the instrument, and is protected from extraneous light by a hinged cover. The analyzer is placed in the portion of the tube at A, and can be rotated, independently of the

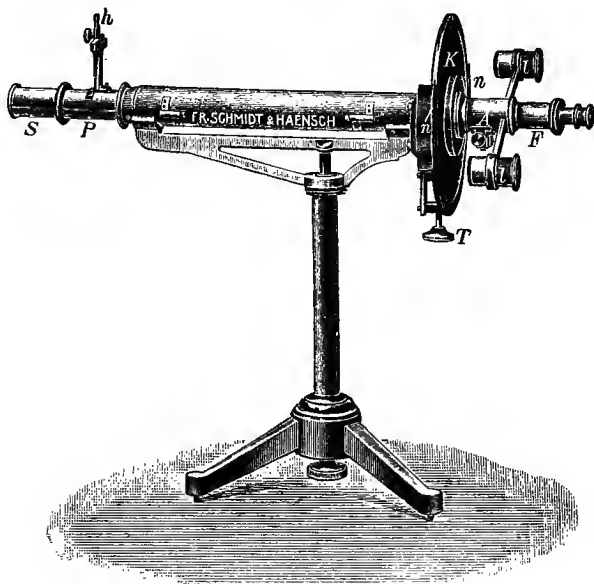

FIG. 37.

graduated circle, by means of a screw. This allows of the correction of the zero point. F is the telescope with eye-piece. K is a graduated disc, which can be caused to rotate, along with the analyzer and telescope, past the fixed verniers n and n' by means of the rack and pinion T.¹ By means of the two

¹ Various arrangements are employed for rotating the analyzer, and the better instruments are also fitted with a fine adjustment.

movable magnifying lenses l , the accuracy of the reading is increased.

Source of Illumination.—As has already been said, the angle of rotation depends on the wave-length of the light used. It is therefore necessary to employ monochromatic light. On account of the ease with which the yellow light of the sodium flame (corresponding with the D line of the solar spectrum) can be obtained, most polarimetric measurements are carried out with this light. For methods of producing the sodium flame, see p. 99.

In order to increase the homogeneity of the light, a light-filter, consisting either of a plate of solid potassium bichromate or of a solution of this substance, is often inserted between the flame and the polarizer.

Observation Tubes.—The observation tube in which the liquid to be examined is placed, generally consists of a tube of



FIG. 38.

thick glass with accurately ground ends. The tube is closed by means of circular plates of glass with parallel sides, which are pressed against the ends of the tube by means of screw-caps (Fig. 38). These caps must not be screwed so tightly that they strain the glass plates. Since the unit of length in polarimetry is 1 dcm., these tubes are made equal to 1 dcm. or to some multiple, *e.g.* 2 or 4 dcm., or a fraction, *e.g.* 0.5 dcm.

For the maintenance of a constant temperature, tubes are also made surrounded by a metal jacket, through which water at constant temperature can be passed. We shall later find a simpler tube to be useful. This tube (Fig. 39) is closed by plates of glass, cemented on with sealing-wax or with Chatterton compound, and is filled through the side tube a

It is surrounded by a mantle through which water can be passed.

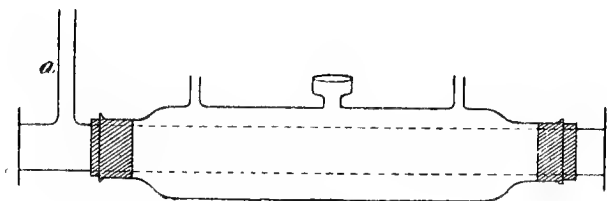

FIG. 39.

Adjustment of the Polarimeter.—Set up the polarimeter so that the polarizer end is opposite to a bright sodium flame, and at about 4 or 5 inches from it. Place a tube full of distilled water in the support between the polarizer and the analyzer, and focus the telescope eye-piece on the line bisecting the field of view, rotating the analyzer if necessary so as to get unequal illumination of the two halves. Now determine the zero point by rotating the analyzer until equal illumination of both halves of the field of view is obtained. This position should be approached several times from either side, readings being made at each of the two verniers (in instruments supplied with these), and the mean of the readings taken. The object of making readings at the two verniers, *i.e.* at points of the graduated circle about 180° apart, is to correct for the excentricity of the latter.

As the zero is altered by alteration of the angle of half-shadow, the position of the lever *h*, which rotates the polarizer, must be fixed before the zero point is determined. In some instruments it is possible to rotate the analyzer without rotating the graduated circle (or the vernier where the latter is movable), and it is therefore possible to adjust the zero so as to eliminate the correction for the zero point. Further, it is possible by this means to adjust the zero to different parts of the graduated scale, and thus eliminate errors in graduation.

EXPERIMENT.—*Determine the Specific Rotation of Cane Sugar.*

Make up a solution of pure cane sugar in distilled water of known concentration. This can be done either by weighing out the sugar, previously dried in a steam oven, dissolving in water, and making the solution up to a definite volume (say 100 c.c.) in an accurate measuring flask (see p. 31); or by weighing both the sugar and the solution, and determining the density of the latter by means of a pycnometer. The strength of the solution used may be about 10 per cent.

Having adjusted the polarimeter as described above and determined the zero point, the sugar solution, contained in an observation tube fitted with a water-jacket, is placed in the polarimeter, and the angle of rotation observed, several readings being taken as in the determination of the zero point. Meanwhile the temperature of the solution is maintained constant, equal say to 20°, by circulating water from a thermostat (see p. 79) through the mantle. Having determined the value of the angle of rotation, the specific rotation is calculated by means of the formulæ on p. 113. The value of $[\alpha]_D^{20}$ for cane sugar is +66.5°. It alters but slightly with temperature.

C.—SPECTROMETRY

When the light emitted by an incandescent gas or vapour is examined by means of a glass prism, a number of differently coloured bands or lines are seen, which constitute what is known as the spectrum of the substance. Moreover, these bands and lines have, for any given substance, perfectly definite positions, so that it is possible, from a determination of the position of the lines, to tell what is the nature of the substance. The determination of the wave length of the different rays emitted by an incandescent gas is, however, of value, not only for the purpose of identifying the substance, but

also on account of the relationships which have been found to exist between the spectra of allied elements.

For ordinary purposes the determination of the wave length of the lines of a spectrum is generally carried out by a method of graphical interpolation, with the help of a number of fixed points. These fixed points are very commonly determined in one of two ways, viz. (1) by determining the angular deviation of lines of known wave length; (2) by determining the position on a fixed scale of lines of known wave length.

Spectrometer.—The apparatus employed for these measurements is called a spectrometer, a simple form of

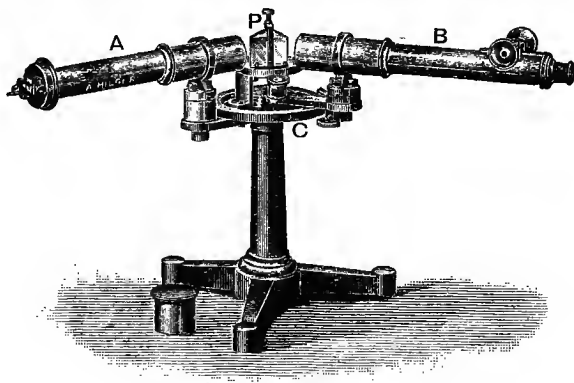

FIG. 40.

which is shown in Fig. 40. The essential parts of the spectrometer are: (1) a collimator, A, at one end of which is an adjustable slit, and at the other a lens by which the rays of light can be rendered parallel—this collimator is clamped in a fixed position; (2) a prism, P; (3) a telescope, B, which can be moved round over a graduated circle, C.

Adjustment of the Spectrometer.—The telescope is removed from its clamp, and the position of the eye-piece

altered until the cross-wires are in focus, the telescope being meanwhile directed to the open sky, or towards a white background. It is then necessary to focus the telescope for parallel rays, *i.e.* for infinity. This is done by pointing the telescope at a distant, sharply defined object (say 100 to 200 or more yards distant), and moving the whole tube containing eye-piece and cross-wires until the object appears sharply focussed. When this is done, the cross-wires and image should not show any relative displacement when the eye is moved in front of the eye-piece. The telescope is now in focus for parallel light.

The telescope is replaced in its clamp, and is directed to look into the collimator, after having removed the prism. The slit of the collimating tube is now illuminated and the distance of the slit from the collimating lens altered until the slit, the image of which should be in the centre of the field of view of the telescope, appears quite sharp. Since the telescope was focussed for parallel light, it follows that the light coming from the collimator is now parallel.

Now place the prism in its place, with its refracting edge parallel with the slit. Illuminate the slit by means, say, of a sodium flame (p. 99), and turn the telescope until the image of the slit is seen. Rotate slowly the table on which the prism stands, or, if the table is fixed, rotate the prism, until it is in the position of minimum deviation. This is done by rotating the prism backwards and forwards, and following the image of the slit with the telescope. In this way it is found that, as the prism is rotated continuously in one direction, the image of the slit appears to move first in one direction, and then at a given point to stop and move in the opposite direction. The position of minimum deviation is that at which the image changes its direction of movement. This position can then be ascertained more exactly, and the prism fixed.

We have now to determine the angular deviation of different spectral lines of known wave-length, by illuminating the slit with different incandescent substances, bringing the cross-wire of the telescope into coincidence with the different lines of the spectra, and reading off on the graduated scale and vernier of the instrument the angle of deviation for the different lines. The angles so read off are plotted as abscissæ against the wave-lengths of the particular lines as ordinates, and a smooth curve drawn through the points so plotted. In this way we obtain a "map" from which the wave-length of any other line can then be obtained, by determining the angular deviation (the prism always being in the same position) of the particular line, and reading off from the curve the corresponding wave-length.

Instead of determining the angular deviation of the different lines, one may make use of a fixed scale. This is contained

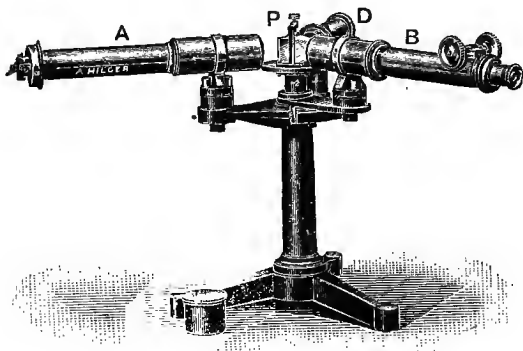

FIG. 41.

in a third tube, D (Fig. 41), and is seen in the telescope by reflection from the face of the prism, the scale being illuminated by a small gas flame or electric lamp placed opposite the end

of the tube. Too strong an illumination should be avoided, otherwise difficulty will be found in seeing the weaker spectrum lines.

To adjust this scale, place a sodium flame in front of the slit of the collimator, and turn the telescope until the D line is seen in the centre of the field of view; illuminate the scale, and focus it quite sharply on the face of the prism; then adjust the position of the scale so that the sodium line coincides with some definite scale mark—say 100. The position of other spectral lines is then read off on the scale, and the scale numbers are plotted against wave-lengths.

EXPERIMENT.—*Construct a Spectrum Map, and determine the Wave-lengths of the Chief Lines of the Spectra of Hydrogen and of Helium.*

The spectrometer is adjusted as described above, the slit being directed towards a clear, non-luminous Bunsen flame, protected from draughts. The prism should be shielded from extraneous light by means of a cloth or a cardboard box. The chlorides of potassium, lithium, sodium, thallium, and strontium are vaporized in the Bunsen flame, and the angular deviations, or the scale-divisions, corresponding with the different well-marked lines of the spectra determined. The substances may be employed in the form of solids, and may be supported in the flame by means of clean platinum wire; or strong solutions of the salts, acidified with hydrochloric acid, may be placed in a glass tube and fed into the flame by means of a wick of fibrous asbestos. Care should be taken that the rays of light always fall on the slit at the same angle, otherwise a slight displacement of the lines will result. All danger of such displacement can, however, be avoided by focussing the light on the slit by means of a lens.

When solids are used, the flame coloration is often rather transient, but can be revived by moistening the solid with hydrochloric acid.

For the construction of the map, the following lines may be plotted :—

Chloride of—	Colour of line.	Wave-length in Ångström units. ¹
Potassium	Red	7669
Lithium	„	6708
Strontium	„	6409
Sodium	Yellow	5893
Thallium	Green	5351
Strontium	Violet	4608

Having constructed the map, a Geissler vacuum tube (preferably an end-on tube, p. 100), containing hydrogen or helium, is fixed before the slit, and connected with the secondary of an induction coil. The chief lines in the case of the hydrogen spectrum are a red line (C line), a blue line (F line), and a violet line; while the chief lines in the helium spectrum are two red lines, a yellow line, two green lines, a blue line, and a violet line. The wave-lengths of the most important lines are as follows :—

Hydrogen.		Helium.	
Line.	Wave-length.	Line.	Wave-length.
C (red)	6563	Red	7056
F (blue)	4861	„	6678
G' (violet)	4341	Yellow	5876
		Green	5016
		„	4922
		Blue	4713
		Violet	4472

¹ One Ångström unit = 1 ten-millionth of a millimetre (= 0.1 $\mu\mu$).

CHAPTER VII

MOLAR WEIGHT OF SUBSTANCES IN SOLUTION

IN Chapter III. we learned how the molar weight of a substance in the gaseous state could be determined; the molar weight being there defined as that weight of gas which at 0° and under the pressure of 760 mm. would occupy a volume of 22,400 c.c. On the basis of the laws of osmotic pressure, and the analogy between a substance in the state of vapour and in dilute solution, we could, in a similar manner, define the molar weight of a substance in solution as that weight which when contained in 22,400 c.c. of solution gives at 0° an osmotic pressure of 760 mm. Closely related to the osmotic pressure is the depression of the vapour pressure of the solvent, so that from this also molar weights can be determined. The direct measurement of the osmotic pressure is difficult, so that for ordinary practical purposes recourse is had to other methods, whereby the molar weight can be determined. These are the determination of the depression of the freezing-point, or the elevation of the boiling-point and the lowering of the vapour pressure of the solvent.

I. FREEZING-POINT (CRYOSCOPIC) METHOD

If w gm. of a substance when dissolved in W gm. of a solvent lower the freezing-point of the latter by d° , the molar weight of the solute is obtained by means of the expression

$$m = k \frac{w}{dW}$$

where k is a constant depending only on the solvent employed. Its value for the commonest solvents employed is given in the following table;—

Solvent.	Freezing-point.	k
Water . . .	0°	1860
Benzene . . .	5.4°	5000
Acetic acid ¹ . .	16.7°	3900

The method can be employed only when the solute does not form an isomorphous mixture (solid solution) with the solid solvent, *i.e.* only when the solvent crystallizes out pure.

Apparatus.—In order to find the value of d in the above expression, it is necessary to determine the freezing-point of the pure solvent and of a solution of known concentration. This determination is carried out in the apparatus shown (Fig. 42).² The cooling bath consists of a glass or stoneware vessel, A, on the top of which rests a lid of brass, L. Through a hole in the centre of the lid there passes a wide glass tube, B, which is fixed in place by means of a cork: and through

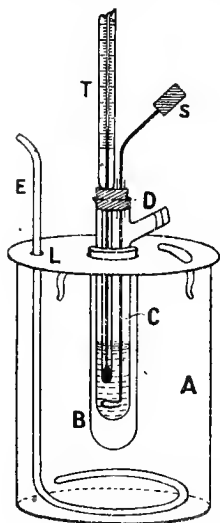

FIG. 42.

¹ In the case of a hygroscopic solvent like acetic acid, special precautions must be taken to prevent access of moisture from the air.

² The method to be described here, and which is due essentially to Beckmann, is that which is most commonly used in chemical laboratories where only a moderate degree of accuracy is required. For a description of the more exact methods and the precautions to be observed, see Ostwald-Luther, "Physikalisch-chemische Messungen."

another opening in the lid there passes a stirrer, E, by means of which the temperature of the bath can be kept more uniform. A third opening in the lid allows of the passage of a thermometer.

The freezing-point tube C, which is furnished with the side tube D, is supported in the neck of tube B by means of a cork or asbestos ring, so that the freezing-point tube is surrounded by an air-mantle. This ensures a slower and more uniform rate of cooling of the liquid. Through a cork in the neck of C there pass a thermometer, T, and a stirrer, S, to the upper end of which a non-conducting handle of cork or wood is attached. To ensure freedom of movement and guidance to the stirrer, the latter is made to pass through a short piece of glass tubing inserted in the cork of the freezing-point tube.

In order to keep the temperature of the cooling bath more uniform, it is well to surround the latter and to cover the lid with thick felt.

Precautions.—Special mention may be made here of a few precautions which should be observed in all determinations of the molar weight by this method:—

1. *The temperature of the cooling bath must not be too low.*

When we consider the factors affecting the temperature of the liquid in the freezing-point tube, we see that they are (chiefly) three in number, viz. abstraction of heat by the cooling bath; addition of heat from the outside by conduction through the stirrer, thermometer, etc.; addition of heat (latent heat of fusion) to the liquid by the solidifying solvent. If, for the moment, we suppose no solidification to take place, it will be evident that the final temperature of the liquid will be the resultant of the action of the first two factors. This temperature, called the *convergence temperature*, will, of course, be all the lower, the lower the temperature of the cooling bath; and it will also, in general, lie below the true freezing-point of the liquid. If, now, in this supercooled liquid, solid begins to

separate out, the latent heat of fusion will be added to the liquid, and the temperature will therefore rise. But the temperature which is now reached will not necessarily be the true freezing-point of the liquid, for it is the resultant of two opposing factors, viz. the rate at which heat is withdrawn (which in turn depends on the difference between the temperature observed and the convergence temperature), and the rate at which heat is given to the liquid, which will depend on the latent heat of fusion and on the velocity of crystallization. Since we can take the velocity of crystallization as being proportional to the degree of supercooling, we see that the final observed temperature will be lower than the true freezing-point by an amount directly proportional to the difference between the observed temperature and the convergence temperature, and by an amount inversely proportional to this difference; that is—

$$T = t + \frac{k}{K}(t - t')$$

where T is the true freezing-point, t the observed freezing-point, t' the convergence temperature, k a constant depending on the rate of abstraction of heat, and K a constant depending on the rate of addition of (latent) heat. In order to diminish the value of the correction $\frac{k}{K}(t - t')$, the temperature difference $(t - t')$ should be made small. This is the reason why the temperature of the cooling bath should not be too low. To obtain the accuracy at which we are at present aiming, the temperature of the cooling bath should not exceed 3° below the freezing-point of the liquid.

2. *The amount of supercooling should not exceed $0.3^{\circ} - 0.5^{\circ}$.*

From the equation given above, it will be seen that the value of the correction $\frac{k}{K}(t - t')$ can also be diminished by increasing the value of K , *i.e.* by increasing the degree of

supercooling and so obtaining the separation of a large amount of the solid solvent. If this is done, however, the concentration of the solution is appreciably altered, and the depression of the freezing-point is therefore apparently too great.¹ For our present purpose, the above limits of supercooling may be taken.

3. *The stirring should not be too rapid, and should be as uniform as possible.*

The stirring should be just sufficiently rapid to maintain the contents of the tube at a uniform temperature. Too rapid stirring should be avoided, so as not to give rise to too much heat by friction. An up-and-down movement of the stirrer at the rate of about once per second will be sufficient.

4. *Always tap the thermometer before taking a reading.*

As the bore of the capillary of the thermometer is very small, the mercury is inclined to "hang," and the purpose of tapping the thermometer with the finger or a small padded hammer is to overcome this.

The Beckmann Thermometer.—In order that the determination of the molar weight shall be made with sufficient accuracy, it is necessary to be able to read the temperatures with an error not exceeding 0.001 – 0.002°. The thermometer should therefore be graduated to, at least, hundredths of a degree. Such a thermometer, however, if made in the ordinary way, would have only a very short range unless its length were made inconveniently great. It would be necessary, therefore, to have a number of these thermometers for use at different temperatures. To obviate this necessity, a thermometer was

¹ The change in the concentration can be calculated as follows: If c is the specific heat of the liquid, L_f the latent heat of fusion, S the amount of supercooling in degrees Centigrade, then the fraction of the total amount of liquid which will solidify will be $\frac{cS}{L_f}$, so that instead of there being $\frac{W_2}{2}$ gm. of solvent to $\frac{W_1}{2}$ gm. of solute, there will now be $\frac{W_2}{2} \left(1 - \frac{cS}{L_f}\right)$.

designed by Beckmann, which, although it does not allow of the absolute temperature being read, enables one to determine differences of temperature at any desired absolute temperature.



The *Beckmann thermometer* (Fig. 43) as usually employed in the laboratory has a range of only five or six degrees; and is generally graduated into degrees, tenths and hundredths of a degree. The peculiarity of the Beckmann thermometer is that the amount of mercury in the bulb, and therefore the temperature at which the thermometer can be used, can be altered. The lower the temperature, the greater must be the quantity of mercury in the bulb.

This regulation of the amount of mercury in the bulb is rendered possible by having at the upper end of the capillary a small reservoir, R, into which the excess of mercury can be driven, or from which a larger supply of mercury can be introduced into the bulb.

Setting the Beckmann Thermometer.—Before using the Beckmann thermometer, it must be “set,” *i.e.* the amount of mercury in the bulb must be so regulated that at the particular temperature of the experiment, the end of the mercury thread is on the scale. This is done as follows:—

Hang the thermometer in a beaker of water the temperature of which is regulated according to the experiment,¹ with the help of an ordinary thermometer graduated, preferably, in fifths or tenths of a degree;²

¹ Since the scale of the Beckmann thermometer does not extend upwards to the end of the capillary, the temperature of this bath must be at least 2° — 3° higher than the highest temperature to be met with in the experiment.

² The accuracy of this thermometer should be tested previously by comparison with a standard thermometer.

FIG. 43.

and see whether or not the top of the mercury of the Beckmann thermometer stands on the scale. If it does not, then suppose in the first place that it does not rise so far as the scale; that is, suppose there is too little mercury in the bulb. In this case, place the thermometer in a bath the temperature of which is sufficiently high to cause the mercury to pass up to the top and to form a small drop at the end of the capillary. Now invert the thermometer, and tap it gently so as to collect the mercury in the reservoir at the end of the capillary and to join with the mercury there. Return the thermometer carefully, without shaking, to the upright position, and place the bulb again in the first bath, regulated at the proper temperature. The mercury in the bulb will contract and draw in more mercury from the reservoir. After several minutes, when the thermometer will have taken up the temperature of the bath, strike the upper end of the thermometer against the palm of the hand so as to cause the excess of mercury to break off from the end of the capillary. Make sure, now, that the amount of mercury has been properly regulated, by placing the thermometer in a bath the temperature of which is equal to the highest that will occur in the experiment, and see that the mercury stands on the scale. If it stands above the scale, too much mercury has been introduced, and some of it must be got rid of by driving the mercury once more up into the reservoir and shaking off a little of it from the end of the capillary. Of course, if the mercury is found to stand too low on the scale, then more mercury must be introduced in the manner described above, these operations being repeated until the proper amount of mercury has been introduced. *This must always be tested by placing the thermometer in a bath at the temperature of the experiment and making sure that the mercury remains on the scale.*

On account of the so-called "thermal after-effects" met with in the case of glass, owing to which glass, after being

heated, does not immediately acquire its original volume (see p. 40), it is advisable to have at least two Beckmann thermometers, one for use at lower, the other for use at higher temperatures.

Tabloid Press.—When the substance under investigation is a solid, it will be found very convenient to compress it into a short rod or tabloid, in which form it can be readily weighed and introduced into the freezing-point tube. For this purpose a mould and press of the form shown is very useful (Fig. 44). The mould consists es-

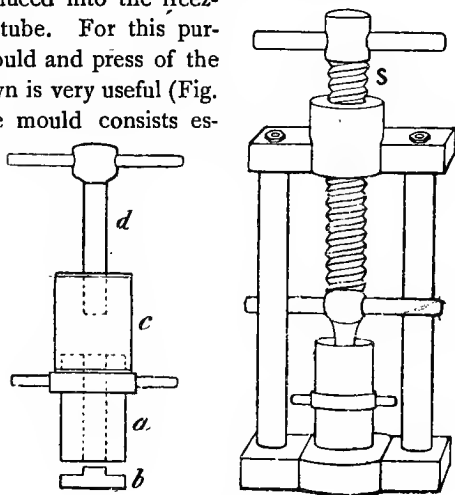

FIG. 44.

entially of a cylinder, *a*, with a circular bore, which can be closed by a metal stopper *b*, a collar *c*, and the plunger *d*.

After carefully cleaning these different parts, the end of the cylinder is closed by the stopper *b*, and the collar *c* is then placed in position over the other end of the mould. The substance to be compressed is placed, in small quantities at a time, inside the collar and gently pressed down the mould by means of the plunger. When a sufficient quantity of the substance has been introduced, the plunger is placed in the

mould and the whole inserted in the press, the substance being then compressed by means of the screw S. Do not, however, compress the substance too much, otherwise it will be very difficult to remove it from the mould. If this should happen, the substance should be dissolved out by means of a suitable solvent.

When the substance has been sufficiently compressed, remove the mould from the press, detach the stopper *b*, place the collar over this end of the cylinder, and, inserting the plunger again in the mould, place the whole once more in the press and force the rod of substance out (Fig. 45).

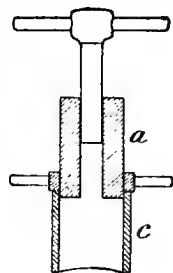

FIG. 45.

After use, the mould and plunger must be well cleaned (if necessary, with the help of a solvent), dried and oiled before being put away.

EXPERIMENT.—Determination of the Molar Weight of a Substance in Benzene.

First set up the apparatus (p. 126) completely, to make sure that the different parts fit properly; and see that the stirrer in the freezing-point tube works smoothly without striking against the bulb of the thermometer. Remove the thermometer and stirrer from the freezing-point tube, and fit the latter, which must be clean and dry, with an unbored cork. Weigh this tube, and then pour in 15–20 gm. of pure benzene, and weigh again. For this purpose a balance weighing to a centigram should be used.¹ Now set the Beckmann thermometer so that at the temperature of 5.5° (melting-point of benzene) the mercury stands not lower than the middle of the scale. Dry

¹ More simply, pipette into the freezing-point tube a known volume, say 25 c.c., of benzene. The mass of this can be obtained by multiplying the volume by the density. In this way the weighing of a rather awkward piece of apparatus is avoided.

the thermometer thoroughly and insert it, along with the stirrer, in the freezing-point tube, so that the bulb of the thermometer is completely immersed in the benzene. Fill the vessel A with water and ice, so that a temperature of about 2° – 3° is obtained. This can be regulated by varying the amount of water and ice. The freezing-point of the benzene is then determined.

In doing this, make a first approximate determination by placing the freezing-point tube directly in the cooling bath,¹ so that the temperature falls comparatively rapidly. When solid begins to separate, quickly dry the tube and place it in the air-mantle in the cooling bath; stir slowly and read the temperature when it becomes constant. Now withdraw the tube from the mantle and melt the solid benzene by means of the hand. If in this operation the temperature of the liquid is raised more than about 1° above the freezing-point, place the tube again directly in the cooling bath and allow the temperature to fall to within about half a degree of the freezing-point as determined above; quickly dry the tube and place it in the air-mantle and allow the temperature to fall, stirring slowly all the while. When the temperature has fallen to from 0.2° to 0.5° below the approximate freezing-point found above, stir more vigorously. This will generally cause the solidification to commence, and the temperature will now begin to rise.² Stir slowly again, and, with the help of a lens, read the temperature every few seconds, tapping the thermometer firmly with the finger each

¹ For this purpose push the lid of the bath aside; do not remove it from the bath.

² It is sometimes found that solidification does not commence in the supercooled liquid, even on stirring vigorously. In such cases too great supercooling should be avoided by the introduction of a small crystal of the solid solvent through the side tube D, the stirrer being raised and touched by the crystal. In cases, therefore, where supercooling readily occurs, it is well to have a tube containing a small quantity of the solidified solvent standing in the cooling bath.

time before doing so. Note the highest temperature reached. Again melt the solid benzene which has separated out, and redetermine the freezing-point in the manner just described. Not fewer than three concordant readings of the freezing-point should be made, the mean of these being then taken as the freezing-point of the benzene. The deviations of the separate readings from the mean value should not exceed 0.002° .

The freezing-point of the solvent having been determined, a weighed amount of the substance (*e.g.* camphor naphthalene), compressed into the form of a rod (p. 132), is now introduced into the benzene through the side tube D, of the apparatus.¹ The amount taken should be sufficient to give a depression of the freezing-point of not less than 0.1° . After the substance has dissolved, the freezing-point of the solution is determined in exactly the same manner as described for the pure solvent; first an approximate and then not fewer than five accurate determinations being made. In each case note the degree of supercooling.

Two further additions of the substance should be made, and the freezing-point of the solution determined after each addition. From each set of determinations, calculate the molar weight of the solute. The error should not exceed 3–5 per cent.

Abnormal Molar Weights.—In the case of a number of substances (very commonly in the case of organic acids and hydroxy-compounds in benzene), it is found that the molar weight determined by the cryoscopic method is greater than that calculated from the usual chemical formula of the substance, by an amount exceeding the experimental error. We are therefore led to the assumption that these substances *associate* in solution, *i.e.* two or more molecules combine to

¹ Where a tabloid press is not available, the substance may be shaken out from a narrow tube inserted through D. This method is, indeed, best in the case of cryoscopic measurements, on account of the time required for the solution of the compressed solid to take place.

form a larger molecule. As an example of this, we may take the case of benzoic acid ($C_6H_5.COOH$) in benzene.

EXPERIMENT.—*In the manner just described, determine the apparent Molar Weight of Benzoic Acid in Benzene, and from the numbers obtained calculate the Degree of Association, assuming that two single molecules combine to form one compound molecule.*

The degree of association can be calculated in the following manner: If x represents the degree of association, or the fraction of the total number of molecules which combine to form larger molecules; and if n represent the complexity of the new molecules, then of each mole of substance taken there will be $1-x$ moles unassociated, and $\frac{x}{n}$ moles associated. Consequently, instead of there being 1 mole there will be only $1-x + \frac{x}{n}$ or $1-x\left(1-\frac{1}{n}\right)$. In other words, the number of dissolved molecules has decreased in the ratio of $1 : 1-x\left(1-\frac{1}{n}\right)$. But the depression of the freezing-point is proportioned to the number of moles (in a given volume); hence, if d_t represent the depression calculated on the assumption of no association, and d_o the depression actually obtained—

$$\frac{d_o}{d_t} = \frac{1-x\left(1-\frac{1}{n}\right)}{1}, \text{ or } x = \frac{d_t - d_o}{d_t\left(1-\frac{1}{n}\right)}$$

Or, if the molar weight is first calculated from the depressions produced—

$$x = \frac{M_o - M_t}{M_o\left(1-\frac{1}{n}\right)}$$

where M_o represents the molar weight calculated from the observed depression, and M_t the molar weight calculated from the chemical formula.

Not only can the molar weight determined from the depression of the freezing-point have a value greater than that corresponding with the ordinary chemical formula of the substance, but it can also have a value much smaller, thus pointing to a *dissociation* of the molecules in solution. This is found, for example, in the case of almost all salts, acids and bases in aqueous solution, and the degree of dissociation (ionization) can be calculated in a similar manner to the degree of association given above. Thus, if x represent the degree of dissociation, and if n be the number of dissociated molecules (ions) formed from each molecule of the solute, then the relative increase in the number of molecules (or molecules plus ions) in the solution will be as $1 : 1 + (n - 1)x$.

Hence, if d_o and d_t represent the observed and the theoretical (on the assumption of no dissociation) depressions, we have—

$$\frac{d_o}{d_t} = \frac{1 + (n - 1)x}{1} \quad \text{or} \quad x = \frac{d_o - d_t}{d_t(n - 1)}$$

Hence, it follows—

$$x = \frac{M_t - M_o}{M_o(n - 1)}$$

(In the case of aqueous solutions, the depression produced by 1 mole of a normal (non-associating and non-dissociating) substance in 1000 gm. of water is 1.860° .)

EXPERIMENT.—*Determine the apparent Molar Weight of Potassium or Sodium Chloride in Aqueous Solution, and from the value obtained calculate the degree of Ionization of the Salt.*

The determination is made in the same manner as in the case of the benzene solutions (p. 133). It may, however, be found that crystallization commences with greater difficulty than in the case of benzene, so that, in order to prevent too great supercooling, it may be necessary to add a small crystal of ice to the supercooled solution.

In the cooling bath, a mixture of a salt solution and ice

should be employed, the temperature being regulated (to -2° or -3°) by varying the strength of the salt solution. To lower the temperature, increase the strength of the salt solution, to raise the temperature diminish it. Ice must always be present.

Calculations—

1. From the determinations of the freezing-point of the benzene solutions, calculate (a) the value of the freezing-point constant; (b) the latent heat of fusion of benzene; the theoretical molar weight being assumed for the solute. (The latent heat of fusion of benzene is 30.1 cal.)

2. From the depression of the freezing-point in the case of the aqueous solutions, calculate the osmotic pressure of the latter, and the latent heat of fusion of ice. (The latent heat of fusion of ice is 79.9 cal.)

3. Determine what error will be introduced into the value of the degree of association or ionization by an error of ± 1 per cent. in the determination of the molar weight.

II. BOILING-POINT (EBULLIOSCOPIC) METHOD

The molar weight of a substance in solution can also be determined from the elevation of the boiling-point which is produced, provided that the solute is not appreciably volatile at the temperature of the boiling solvent.

If w gm. of a substance when dissolved in W gm. of a solvent raise the boiling-point of the latter by e° , the molar weight of the dissolved substance is given by the expression—

$$M = k \cdot \frac{w}{e \cdot W}$$

in which k is a constant, the value of which depends only on the solvent. Its value for a few of the more common solvents is given in the following table :—

Solvent.	Boiling-point.	<i>k</i>
Ether	34.9°	2100
Acetone	56.3°	1700
Benzene	80.3°	2700
Water	100.0°	520
Ethyl alcohol	78.3°	1150

Apparatus and Method.—The apparatus which is generally employed for the purpose of molar weight determinations by the boiling-point method is that designed by Beckmann, one form of which, together with the manner of using it, will be described here.

The apparatus (Fig. 46) consists of a boiling tube, with a long side tube surrounded by a water condenser, C. A Beckmann thermometer, T, passes through the cork in the end of the tube, which is surrounded by a mantle, M, made of glass, porcelain, or metal, in which a quantity of the solvent is kept boiling. By this means the boiling solvent or solution in A is surrounded by a jacket of nearly constant temperature, so that the heating is made more uniform and the tube is protected against loss of heat by radiation. The mantle and boiling tube rest on an asbestos heating box, F.

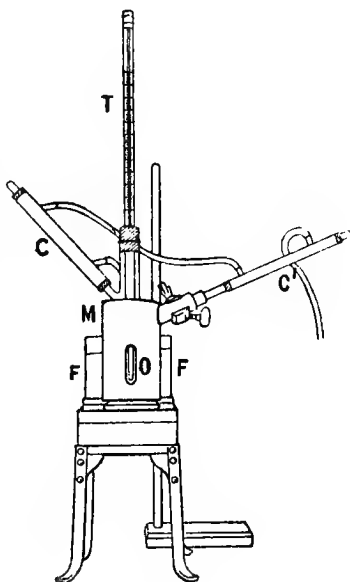

FIG. 46.

in the centre of which is a hole filled in with wire gauze; and it is well to cover this gauze with a thin layer of teased asbestos fibre. Two chimneys, F, carry the hot air up past the apparatus. To prevent the passage of currents of air between the boiling tube and the mantle, the former should be fixed into the latter by means of a ring of asbestos paper.

In the case of the porcelain mantles, there are two openings, O, pierced on opposite sides of the mantle, which enable one to see the liquid in the boiling tube. To protect the boiling tube from the surrounding air, these openings should be filled in with mica.

Manipulation.—Before commencing the determination of the boiling-point of the solvent, the thermometer must be set (p. 130) so that the mercury stands not higher than the middle of the scale at the boiling temperature of the solvent. The boiling tube is fitted with unbored corks and weighed, and then about 15–20 gm. of the solvent introduced and the tube reweighed.¹ In order to secure uniform ebullition and to prevent superheating, glass beads, garnets, or similar material, are introduced into the tube, so as to form a layer about 3–4 cm. deep; the thermometer is then placed in position, so that the bulb is a few millimetres above the beads and is entirely surrounded by liquid.

About 10–15 c.c. of the solvent (residues from former experiments) are introduced into the mantle along with a few beads or pieces of porous tile (to prevent bumping). The mantle, with the condenser, C', attached, is supported in position on the heating box, and the boiling tube inserted in the mantle, so that the end of it rests on the wire gauze of the heating box. The condensers of the mantle and the boiling tube are fitted up in series, so that the water passes from the one (boiling-tube condenser) to the other, and a flame is then placed under the heating box. This flame, which should be protected from draughts by means of a chimney, and, if necessary,

¹ Or use the method given in the foot-note, p. 133.

also by screens, should not be placed immediately under the boiling tube, but somewhat to the side; and the size of the flame and its position should be so chosen, that the liquid both in the boiling tube and the mantle is kept in a state of vigorous ebullition. In the case of the liquid in the mantle, this condition can be gauged from the amount of vapour which condenses. As the temperature registered by the thermometer varies slightly with the vigorousness of the ebullition, the latter should be maintained as uniform as possible throughout a series of determinations.

The boiling-point of the pure solvent must first be determined. It will be found that perhaps twenty minutes or half an hour will elapse before the temperature of the liquid becomes constant; and the final reading of the thermometer should not be made until the mercury has remained stationary for about ten minutes.¹ As mentioned previously (p. 129), the thermometer must be tapped firmly with the finger before a reading is taken.

While the temperature is becoming constant, tabloids of the substance to be investigated should be prepared and weighed. When the temperature has become constant, one of these weighed tabloids should be introduced through the side tube into the solvent, and the temperature again noted, after it has risen and remained constant for five minutes. Two further quantities of the substance should be introduced, and the temperature read after each addition. From the boiling-points of the pure solvent and of each of the solutions, the molar weight is calculated for each concentration. In making the calculation, 0.2 gm. should be subtracted from the weight of solvent taken, when this is benzene, ether, acetone, etc., to allow for the vapour contained in the tube and condenser; in the case of water, 0.35 gm. should be deducted.

¹ Considerable fluctuations of the temperature may be caused if the apparatus is placed in a draught, or if the flame is placed immediately under the boiling tube.

On account of the influence of pressure on the boiling-point, the barometric pressure at the beginning and end of the experiment should be noted, and, if necessary, a correction applied.¹

In the case of the determination of the molar weight of liquids, the latter are introduced into the boiling tube by means of a pipette with long tube (Fig. 47).

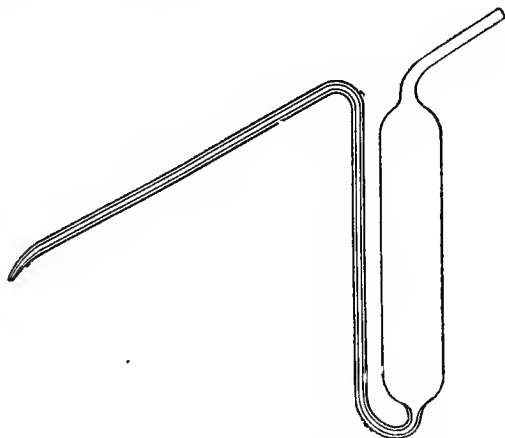

FIG. 47.

EXPERIMENT.—*Determine the Molar Weight of Camphor or of Anthracene in Benzene.*

EXPERIMENT.—*Determine the Molar Weight of Ethyl Benzoate in Benzene.*

Calculation—

Assuming the theoretical molar weight of the solute, calculate, from the measurements made, the heat of vaporization of the solvent and the value of the boiling-point constant. The following are the values of the latent heat of vaporization of the solvents previously mentioned.

¹ See Ostwald-Luther, "Physiko-chemische Messungen," p. 307.

Ether	84.8 cal.
Acetone	125.3 „
Benzene	94.6 „
Water	538 „
Ethyl alcohol	216.4 „

Method of Electrical Heating.—Where electricity is readily available, the method of electrical heating possesses in ordinary laboratory practice, a number of advantages as compared with the method just described.¹ For this method, the boiling-point tube may remain the same as used with gas heating. Through the cork pass, besides the thermometer, two long glass tubes, into the ends of which the ends of a spiral of platinum wire are sealed. This wire is connected with a battery of four or more lead accumulators by means of mercury and stout copper wires. The glass tubes should be pushed so far through the cork that the platinum spiral almost touches the bottom of the boiling tube, and the spiral should be covered to a depth of 1–2 cm. with garnets or glass beads. The boiling tube is placed in a silvered Dewar vacuum tube, which takes the place of the porcelain vapour mantle. The current necessary (a few amperes) to boil the liquid will vary with the solvent employed, and should be regulated by means of a sliding resistance. In other respects, the manipulation is the same as with the method described above.

Instead of the ends of the heating spiral being sealed into glass tubes passing through the cork, they may be fused into the walls of the boiling tube itself, and electrical connection thus made direct with the battery.

Landsberger-Walker Method.—For ordinary chemical purposes, when it is only desired to decide what multiple of the empirical formula of a compound represents the molecule; where, therefore, an accuracy of 5–10 per cent. is sufficient, the Landsberger method, as modified by Walker and Lumsden,

¹ For an investigation of this method, see Beckmann, *Zeitschr. physikal Chem.*, 1908, 63, 177.

may also be employed. The advantage which this method possesses is, that several determinations of the molar weight can be carried out with one and the same sample of material, so that only one weighing is necessary, Instead also of determining the amount of the solvent by weight, its amount

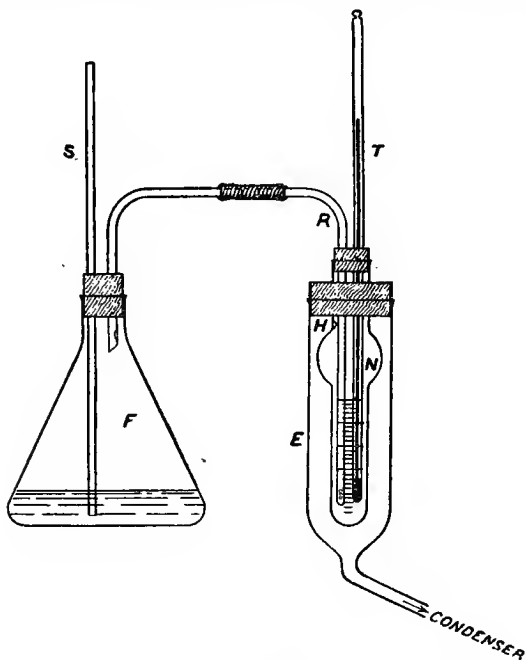

FIG. 48.

by volume is measured; this makes no difference in the calculation, except that a different constant is employed, which is equal to the Beckmann constant divided by the density of the solvent at its boiling-point.

Apparatus.—The apparatus (Fig. 48) consists of a boiling flask F, and a graduated tube N, surrounded by the wider

tube E, which is connected at the bottom with a condenser. The graduated tube is fitted with a cork carrying a thermometer, T, graduated in tenths of a degree, and a tube, R, by means of which vapour can be led into the tube N from the boiling flask. Excess of vapour passes out through the hole H, near the top of N, forms a hot mantle for the graduated tube, and is then condensed, and can be used over again in the flask F. S is a safety-tube.¹

Carrying out a Determination.—The apparatus is fitted together as shown in the figure, the boiling flask containing a quantity of the pure solvent. About 10–12 c.c. of the solvent are also placed in the graduated tube, and vapour is then passed through it from the flask F, until the drops fall regularly from the condenser at the rate of one a second, or one every two seconds. The temperature is then read on the thermometer with the help of a lens, the hundredths of a degree being estimated.

The boiling-point of the pure solvent having been thus determined, most of the liquid is poured out of the graduated tube, only 5–7 c.c. being left. In this a weighed quantity of the substance to be investigated is dissolved, and the apparatus again fitted together. Vapour is then passed through the solution until the liquid drops from the condenser at the same rate as before. The temperature is now read, and the boiling flask immediately disconnected from the graduated tube. If the solvent is inflammable, the flame must first be removed or extinguished. Remove the thermometer and the inlet tube,² place the graduated tube in a perpendicular position, and read the volume of the liquid, the tenths of a cubic centimetre being estimated. The upright position of the graduated tube is best ensured by passing it through a hole in a wooden board which

¹ A more compact form has been given to this apparatus by Beckmann; *Zeitschr. physikal. Chem.*, 1905, **53**, 137.

² Taking care, however, not to lose any of the adhering solution.

rests on the ring of a retort stand. The hole in the board should be just large enough to allow the narrow part of the tube to pass through, so that the bulb of the tube rests on the wood.

After having determined the volume of the solution, put the different parts of the apparatus together again, and again pass vapour through the solution, until the liquid drops from the condenser at the same rate as before. Read the thermometer and measure the volume of the liquid as above. Three readings of the temperature and the corresponding volume should, if possible, be made.

To ensure the uniform ebullition of the solvent in the flask F, a fresh piece of porous tile should be placed in the flask each time the apparatus is disconnected and before proceeding to pass the vapour into the solution.

The molar weight is calculated by means of the formula—

$$M = K \cdot \frac{w \text{ soln. } F_c}{e v}$$

where K is a constant for the solvent employed, w the weight in grams of the substance taken, e the elevation of the boiling-point, and v the volume of the solution. The values of some of the constants are as follows :—

Solvent.	Boiling-point.	K	Solvent.	Boiling-point.	K
Acetone .	56·3°	2220	Chloroform	61·2°	2600
Alcohol .	78·3°	1560	Ether . .	34·9°	3030
Benzene .	80·3°	3280	Water . .	100°	540

The best solvents to employ are alcohol and acetone. With benzene the volume of the solution increases so rapidly on account of the low heat of condensation of benzene vapour, that not more than two, sometimes not more than one reading can be obtained with the same weight of solute. Water is also not a good solvent to use, on account of the fact that for a

given strength of solution, only a comparatively small elevation of the boiling-point is obtained.

EXPERIMENT.—*Determine the Molar Weight of Benzoic Acid in Acetone and in Ethyl Alcohol.*

Apparatus of McCoy.—To overcome the defects inherent in the Walker-Lumsden apparatus, a number of modifications have been devised, one of the most convenient of which, for ordinary laboratory work, is that due to McCoy.¹ This apparatus (Fig.

49) consists of a tube B which serves both as a boiling tube and as a vapour jacket. Inside this there passes the narrower tube A, which is graduated from the volume 10 c.c. to the volume 35 c.c. from the closed end of the tube. Sealed into the wall of A is the narrow tube *ab*, the lower (closed) end of which is perforated with a number of small holes. The graduated tube, A, is fitted with a cork carrying a Beckmann thermometer, and a side-tube, *c*, connects it with a condenser C.

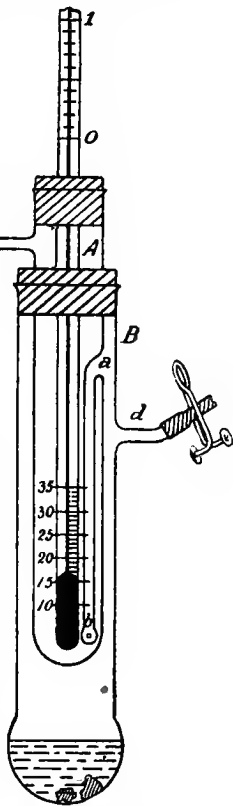

FIG. 49.

Carrying out a Determination.—

About 50 c.c. of pure solvent are placed in B, together with a

¹ Obtainable from Eimer and Amend, New York. Other modifications designed to enable the apparatus to be used for accurate determinations of molar weight have also been introduced. References to the more important of these are given at the end of the chapter.

piece of porous tile, to ensure steady ebullition; 12-15 c.c. of the solvent are also placed in the graduated tube A, and the apparatus then fitted together as shown in the figure. The solvent in B is then caused to boil, while the side-tube *d* is closed by a clip.¹

As the vapour rises in the tube B it heats the solvent in the inner graduated tube, and then forces its way through the narrow tube *ab* into the liquid in the inner tube, and raises its temperature to the boiling-point. The rate of boiling in the outer tube should now be adjusted so that the solvent in the inner tube boils slowly but regularly, and a very slow distillation into the condenser takes place.

When the thermometer registers a constant temperature, the reading is taken as the boiling-point of the pure solvent.

The clip on the side-tube *d* is now opened, and the heating of the liquid in the outer tube interrupted. (The side-tube *d* is opened *before* the heating is interrupted, otherwise liquid may be sucked over from the inner tube through *ab* owing to the cooling down of B.)

A weighed amount of substance, the molar weight of which is to be determined, is now introduced into the inner tube, and the above method of procedure repeated until a constant boiling-point is again obtained. After reading off the boiling temperature of the solution, tube *d* is again opened and the boiling in B stopped. The thermometer is carefully raised out of the solution, and the volume of the latter is read.

After replacing the thermometer a fresh determination of the boiling-point can be made exactly as explained above.

¹ In the case of inflammable liquids, more especially, electrical heating should, when possible, be used. For this purpose a current of electricity may be passed through a spiral of resistance wire, placed in the liquid in the tube B; or, the boiling tube may be placed on an electrical hot plate. For the latter method of heating the cheap asbestos-woven wire resistance nets now obtainable serve admirably.

Owing to the condensation in the inner tube of a certain quantity of the solvent vapour, the concentration of the solution, and consequently the boiling-point, will show a change in each successive determination, so that one thereby obtains a series of boiling-points corresponding to different concentrations, from which the molar weight of the solute can be calculated. Owing, however, to the fact that the liquid in the inner tube is raised to near its boiling-point by the vapour in the tube B, the amount of condensation, and consequently the change in concentration produced is comparatively small, but will depend on the ratio of the latent heat of vaporisation to the specific heat of the solution. In some cases (*e.g.* water) it may be necessary to add small quantities of the solvent to the solution in the inner tube in order to obtain a series of different concentrations.

The molar weight is calculated as before (p. 146).

EXPERIMENT.—*Determine the Molar Weight of Benzoic Acid in Acetone and in Ethyl Alcohol ; of Naphthalene in Benzene ; and of Carbamide in Water.*

III. LOWERING OF THE VAPOUR PRESSURE.

By the direct measurement of the difference between the vapour pressure of a pure solvent and a solution, one can also determine the molar weight of a solute, on the basis of the well-known relationship that the lowering of the vapour pressure of a solvent by the addition of a substance soluble in it, is proportional to the molar concentration of the solute. In the case of aqueous solutions, the method of bubbling air through the solvent and solution, whereby one determines the relative lowering of the vapour pressure, can be employed ; but the method is not generally applicable to solvents other than water. The following method, however, due to Menzies, by which the lowering of the vapour pressure of the solvent

is directly measured, is capable of yielding results which are as accurate at least as those given by the methods already described, and is also applicable to different volatile solvents.

Apparatus.—The apparatus¹ (Fig. 50) consists of a

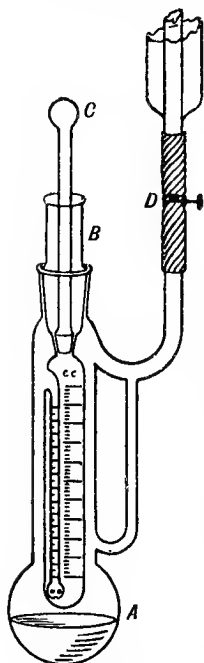

FIG. 50.

boiling tube A to which a reflux condenser is attached. Inside A there is the "test-tube" B, fitted into the neck of the former by means of a ground-glass joint, and graduated in cubic centimetres. Sealed into the wall of B is a narrow gauge-tube graduated in millimetres of length. The lower, closed end of this gauge-tube is perforated by a number of holes. The neck of the "test-tube" can be closed by means of a glass rod, C, ground at one end so as to form a stopper. In carrying out a determination, the solution is contained in the "test-tube" while pure solvent is boiled in A. The temperature of the solution is thus maintained constant at the boiling-point of the pure solvent; and the difference in level of the liquid in the "test-tube" and in the gauge-tube, measures the difference of vapour pressure of solvent and solution in terms of millimetres of the liquid.

Carrying out a Determination.—

Pure solvent is placed in the tube A in amount sufficient to fill the bulb about two-thirds full, and the empty "test-tube," stoppered, then placed in position. The solvent is now caused to boil freely for about ten minutes with the clip, D, on the

¹ Obtainable from the Central Scientific Co., 349, W. Michigan Street, Chicago, Ill.

tube connecting with the condenser open,¹ in order to free the solvent from dissolved air. The boiling is then stopped, the "test-tube" removed and charged two-thirds full with the boiled-out solvent from the tube A, and again replaced, but left unstoppered. The liquid in the jacket tube is again boiled for a minute or two to expel air, and the clip D then closed. The vapour now bubbles through the liquid in the test-tube, whereby any dissolved air is expelled. After a few minutes, the stopper is warmed up by placing it obliquely in the mouth of the "test-tube," and is then pushed home; the small amount of liquid which will have condensed round the stopper will serve to render the joint gas-tight. At the moment of inserting the stopper, the clip D is opened. Boiling is continued for some minutes, while the apparatus is occasionally shaken slightly, in order to allow the temperature of the vapour chamber to attain the true boiling-point of the solvent. The level of the liquid in the gauge-tube and "test-tube" is now read with the help of a hand lens, and this is taken as the zero reading. If the solvent is sufficiently pure, the difference of level of liquid in the two tubes should not be greatly different from what existed before the stopper was inserted. A marked difference indicates that the passage of vapour through the liquid must be continued.

The stopper is now removed and a weighed amount of substance introduced into the solvent in the "test-tube," and vapour is again caused to pass through the liquid as before, until the solution has become homogenous and free from air. The stopper is again inserted and the apparatus shaken jerkily at short intervals in order to wash the upper portion of the walls of the vapour chamber. When the difference in the level of the liquid has become constant (in about ten minutes),

¹ In place of the rubber tube and clip between the boiling flask and the condenser, one may also, when necessary, employ a glass tap with wide bore.

a reading is made and corrected for the zero reading. The liquid round the stopper is now removed by means of filter-paper, the stopper removed, and the volume of the solution is read off.

Further determinations may be made by adding further quantities of the solute, and proceeding as already described.

The molecular weight of the solute can be calculated from the expression

$$M = K \frac{1000 \cdot w \cdot B}{l \cdot v \cdot 760}$$

where K is a constant for the particular solvent,¹ w is the weight of solute added, B is the barometric height, l the lowering of pressure in millimetres of solvent (or solution), and v is the volume of the solution in cubic centimetres.

The value of K for the more common solvents is as follows:—

Solvent.	K	Solvent.	K
Acetone	1061	Chloroform . .	620.4
Alcohol	871.5	Ether	1577
Benzene	1214	Ethyl acetate .	1320
Carbon disulphide .	526.6	Water. . . .	202.5

References.—Beckmann, *Zeitschr. physikal. Chem.*, 1908, **63**, 177; Walker and Lumsden, *Trans. Chem. Soc.*, 1898, **73**, 502; McCoy, *Amer. Chem. J.*, 1900, **23**, 353; Menzies, *J. Amer. Chem. Soc.*, 1910, **32**, 1615.

¹ The value of this constant, which denotes the lowering of the vapour pressure in millimetres of the boiling solvent that would be caused by the presence of one mole of non-volatile solute in one litre of solution, will vary with the barometric height. The values given here are for the standard pressure of 76 cm. The error produced by a change of barometric pressure of 10 mm. is only about 1 part in 1000.

CHAPTER VIII

DISTRIBUTION OF A SUBSTANCE BETWEEN TWO NON-MISCIBLE SOLVENTS

AN operation which is frequently practised, especially in organic chemistry, is that of extracting a substance from its aqueous solution by means of ether. The underlying principle of this method is that when a substance is shaken with two non-miscible solvents, it is distributed between them in a definite manner, which depends on the solubility of the substance in each of the solvents separately.

The ratio in which the solute is distributed between the two solvents depends, however, not only on its solubility in each, but also on whether or not it possesses the same molar weight in the two solvents; and for this reason, the study of the relationships which obtain here are of importance in chemistry, as affording a means of determining the state of association or dissociation of a substance in solution.

I. *The solute has the same molar weight in each of the solvents.*

When the solute has the same molar weight in each of the solvents, it is distributed between them in a ratio which depends on the temperature, but is independent of the absolute concentration. Hence, if c_1 denote the concentration (in moles per litre) of the solute in the first solvent, and c_2 the concentration in the second solvent, then when equilibrium has been established between the two solutions, the ratio $\frac{c_1}{c_2}$ has a constant

value, provided the temperature is constant. The value of this ratio is called the *coefficient of distribution* or the *coefficient of partition*.

EXPERIMENT.—*Determine the Coefficient of Distribution of Succinic Acid between Ether and Water.*

No special apparatus is required for this experiment; a bottle, preferably tall and narrow, furnished with a well-fitting glass or rubber stopper, may be used. In the bottle place 100–150 c.c. of an aqueous solution¹ (approximately 1 per cent.) of succinic acid, and add an equal volume of ether, and then immerse the bottle up to the neck in a thermostat, the temperature of which is maintained constant, say at 25°. The bottle should be kept in the thermostat for about half an hour, and should be shaken vigorously every four or five minutes. After a final shaking, a rotatory motion is imparted to the solutions, in order to loosen any drops of liquid which may adhere to the sides of the bottle, and the bottle again placed upright in the thermostat until complete separation into two layers has taken place. The concentration of the acid in the ethereal layer is then determined by removing the solution by means of a pipette, and titrating with $\frac{n}{20}$ or $\frac{n}{40}$ baryta solution (p. 162), using phenolphthalein as indicator. The end of a bent capillary tube is then placed in the aqueous solution, and the latter siphoned off into a clean flask, and also titrated with baryta solution. The first cubic centimetre or so of the aqueous solution should be rejected.

Having determined the concentrations of succinic acid in the aqueous and ethereal solutions, repeat the determination as above for different total concentrations, using approximately 0.5 and 0.25 per cent. aqueous solutions to start with.

¹ In this, as in all the other experiments in this chapter, distilled water free from carbonic acid should be employed. For method of preparation, see p. 161.

Tabulate the values of c_1 , c_2 , and $\frac{c_1}{c_2}$ obtained in each case.

II. *The molar weight of the solute in the two solvents is different.*

If, in the one solvent, the solute has the normal molar weight, but in the second solvent is partially associated according to the equation—



then, at a given temperature, the ratio $\frac{c_1}{c_2}$ will no longer be constant.

According to the law of partition, however; there exists a constant ratio of partition for each class of molecule; hence a constant ratio should be found between the concentration of the *single* molecules in the first solvent and the *single* molecules in the second solvent. But, according to the law of mass action, the concentration of the single molecules in the second solvent is proportional to the n^{th} root of the total concentration (provided that the degree of association is large); and therefore, if c_1 is the concentration of the solute in the first solvent, and c_2 the concentration in the second, the ratio $\frac{c_1}{\sqrt[n]{c_2}}$ should be a constant.

EXPERIMENT.—*Determine the Partition Coefficient of Benzoic Acid between Water and Benzene, or between Water and Chloroform, at 25°.*

The determination is carried out as described for the preceding experiment. Three solutions of benzoic acid in benzene, of strengths approximately 10, 6, and 4 per cent., should be prepared; for each determination 50 c.c. of the benzene solution and an equal volume of water (free from carbonic acid) should be shaken together, and 10 c.c. removed for titration.

Since, at the concentrations given above, the benzoic acid

exists for the most part as associated molecules $(C_6H_5.COOH)_2$ in the benzene solution, the ratio $\frac{c_1}{\sqrt{c_2}}$ should be found constant.

Tabulate the values of c_1 , c_2 , $\frac{c_1}{c_2}$, and $\frac{c_1}{\sqrt{c_2}}$.

Determination of the Molar Weight of Dissolved Substances

From what has been said, it will be evident that from a study of the ratio of distribution of a substance between two non-miscible solvents, the *relative* molar weight of the substance in the two solvents can be determined. Further, from the change, if any, in the value of the partition coefficient with concentration, valuable information, quantitative as well as qualitative, can be obtained with regard to the change in molar weight, owing to association or dissociation, in the two solvents. To illustrate this, the following experiments should be performed:—

EXPERIMENT.—*Determine the Change in the Value of $\frac{c_1}{\sqrt{c_2}}$ with Concentration in the Distribution of Benzoic Acid between Water and Benzene, and calculate therefrom the Dissociation Constant of $(C_6H_5.COOH)_2$.*

It has just been found that in fairly concentrated solutions of benzoic acid, the ratio $\frac{c_1}{\sqrt{c_2}}$ in water and benzene is constant at constant temperature. As we pass to more and more dilute solutions, however, two factors affect the constancy of this ratio to an increasing extent. These are, the increasing ionization of the benzoic acid in the aqueous solution, and the dissociation of the double into single molecules in the benzene solution. The value of the latter factor can be determined from the change in the value of the partition coefficient in dilute solutions.

Let c_1 = the concentration in the aqueous phase,
 c_2 = " " benzene phase,
 α = the degree of ionization of the acid in water,

and, therefore, $c_1(1 - \alpha)$ = the concentration of the normal unionized molecules in the aqueous phase.

If d is the affinity constant of the acid (see Chap. IX.), we have—

$$d = \frac{\alpha^2}{(1 - \alpha)v}$$

where v is the volume in litres containing 1 mole of acid. Hence—

$$\alpha = \frac{dv}{2} \left(\sqrt{1 + \frac{4}{dv}} - 1 \right)$$

(For benzoic acid $d = 6 \times 10^{-5}$.)

Further, according to the law of partition, the ratio of concentrations of the single molecules in the two solutions is constant. Therefore, if m = concentration of the *single* molecules in benzene—

$$\frac{c_1(1 - \alpha)}{m} = k; \text{ or, } m = \frac{c_1(1 - \alpha)}{k}$$

If, now, we apply the law of mass action to the dissociation of the double into single molecules, we have (since $c_2 - m$ is the concentration of the double molecules)—

$$\frac{m^2}{c_2 - m} = K$$

Hence, from the equation $m = \frac{c_1(1 - \alpha)}{k}$, we obtain—

$$K = \frac{\{c_1(1 - \alpha)\}^2}{k^2 \cdot c_2 - c_1(1 - \alpha)k}$$

Since K is constant independently of the concentration, we

have for any other concentrations c'_1 and c'_2 in the aqueous and benzene solutions—

$$\frac{\{c'_1(1 - \alpha')\}^2}{k^2 c'_2 - c'_1(1 - \alpha')k} = K = \frac{\{c_1(1 - \alpha)\}^2}{k^2 c_2 - c_1(1 - \alpha)k}$$

With the help of these two equations, the value of k can be calculated. From the value of k we can obtain the value of m , and hence also the value of K , the dissociation constant of the complex molecules.

The measurements are to be carried out in the manner explained above, the concentrations of the benzoic acid in the aqueous and benzene solutions being determined by titration with baryta ($\frac{n}{50}$ to $\frac{n}{100}$), using phenolphthalein as indicator. Water free from carbonic acid must be used in all cases.

The first determination should be made by shaking 200 c.c. of a benzene solution containing about 5 gm. of benzoic acid with 200 c.c. of water, and withdrawing 50 c.c. for a titration. After each titration replace the solutions removed by equal volumes of water and benzene.

A series of three or four determinations should be made, and the value of K calculated for the different concentrations. The deviations from the mean should not exceed 3–5 per cent.

Instead of studying the distribution of benzoic acid between water and benzene, one may, as alternatives, study the distribution of benzoic acid between water and chloroform, of salicylic acid between water and benzene, or of salicylic acid between water and chloroform.

Determination of the Degree of Hydrolysis of Salts

Since in the aqueous solution of a salt of a weak base and a strong acid, or of a weak acid and a strong base, there is an equilibrium between the salt, the free base and the free acid, this equilibrium can be determined by studying the partition of the

weak base or weak acid between water and another solvent, such as benzene or chloroform.

Thus, if an aqueous solution, say of aniline hydrochloride, which is partially hydrolyzed into aniline and hydrochloric acid, is shaken with benzene, the free aniline will distribute itself between the water and the benzene in the ratio of the partition coefficient. Hence, from the concentration of the aniline in the benzene solution, the concentration of the free aniline, and from this the degree of hydrolysis in the aqueous solution, can be calculated in the following manner:—

The hydrolysis of a salt is represented by the equation—

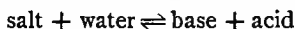

and for all mixtures of acids and base, or of salt and water, the equilibrium is given by Guldberg and Waage's law of mass action as—

$$m_1 \cdot m_2 = k \cdot m_3 \cdot m_4.$$

where m_1, m_2, m_3, m_4 are the concentrations of base, acid, salt, and water respectively. Since the concentration of the water remains practically constant, m_4 is constant, and therefore $k \cdot m_4$ is also constant, and equal say to K .

Let c_1 = initial amount of hydrochloric acid.

c_2 = „ „ aniline (or weak base).

c = concentration in gm.-equivalents per litre of the weak base in the aqueous layer.

F = coefficient of distribution of the base between water and the other solvent, say benzene.

q = volume of benzene employed per 1000 c.c. of water.

Then, when equilibrium is established, $c = m_1$. But if there are c gm. in 1000 c.c. of the aqueous solution, there must be cqF gm. in the benzene solution. Hence, the total quantity of free base is $c(1 + qF)$. The initial amount of base was c_2 , hence

there must be $c_2 - c(1 + qF)$ gm. of the base in the form of the salt (existing in the aqueous layer only). The concentration of the salt is therefore $m_3 = c_2 - c(1 + qF)$. There must, of course, be an equivalent amount of acid in combination, and as the initial amount was c_1 , the amount of combined acid must be $c_1 - c_2 + c(1 + qF)$ gm. As the salt exists only in the aqueous layer (1000 c.c. in volume), the concentration of the acid is $m_2 = c_1 - c_2 + c(1 + qF)$. Substituting these values for m_1 , m_2 , and m_3 in the above equation, we obtain—

$$c\{c_1 - c_2 + c(1 + qF)\} = K \cdot \{c_2 - c(1 + qF)\}$$

$$\text{or } K = \frac{c\{c_1 - c_2 + c(1 + qF)\}}{c_2 - c(1 + qF)}$$

If the acid and base are taken in equivalent proportions, *i.e.* if one dissolves the salt in water, then $m_1 = m_2$, and $m_3 = c_2 - m_1$. Hence—

$$m_1^2 = K \cdot (c_2 - m_1)$$

Having obtained the value of K , and knowing the value of c_2 , m_1 can be calculated. But the degree of hydrolysis is the ratio of free base actually present to what would be present if no salt formation took place, *i.e.* if the whole of the base taken remained free. The degree of hydrolysis is therefore given by $\frac{m_1}{c_2}$, or the percentage hydrolysis by $\frac{100 m_1}{c_2}$.

EXPERIMENT.—*Determine the Percentage Hydrolysis of Aniline Hydrochloride at 25°.*

The partition coefficient, F , of the free base between water and benzene must first be determined. For this purpose, shake up a known quantity of aniline with a mixture of 1000 c.c. of water and 60 c.c. of benzene in a bottle, placed in a thermostat at 25°. After equilibrium has been established, allow the layers to separate and withdraw 50 c.c. of the benzene layer. Into this solution pass dry hydrogen chloride, in order to

precipitate the aniline as hydrochloride, and evaporate off the benzene by gently heating on the water bath, at the same time drawing a current of air over the surface of the liquid.

A known weight of salt (equivalent amounts of acid and base) is then shaken with the same quantities of water and benzene (1000 c.c. and 60 c.c. respectively), and the amount of aniline in the benzene layer determined as above. Instead of using the salt, one may preferably proceed as follows: Shake up 1000 c.c. of a solution of hydrogen chloride of known concentration (say $\frac{n}{10}$) with 60 c.c. of benzene, in which an amount of aniline equivalent to the hydrochloric acid taken, is contained.

In order to allow for the solubility of benzene in water, and loss by evaporation during the experiment, 1 c.c. should be subtracted from the volume of benzene taken, *i.e.* the total volume of benzene should be taken as 59 c.c.

The following results may serve as a comparison:—

Base.	F	Initial conc. of acid and base.	Weight of hydrochloride from 50 c.c. of benzene solution.	σ	Percentage hydrolysis.
Aniline . .	10·1	0·09969 0·03138	0·0806 0·0406	0·00123 0·000621	1·56 2·51

Preparation of Water free from Carbonic Acid.—

Water can be freed from carbonic acid by drawing a current of air, free from carbon dioxide, through the water. The air is purified by passing through a tube containing, first, a layer of calcium chloride, then a layer of soda-lime, and lastly (at end next the water), a layer of cotton-wool. This operation should, of course, be carried out in an atmosphere free from fumes (not in the ordinary laboratory), and the air should preferably be drawn from out-of-doors.

The water is preserved in a flask (preferably of Jena glass), or in a bottle fitted with a siphon tube passing through a closely fitting rubber stopper, or cork protected by paraffin; and the air which enters into the flask, on withdrawing water, should be made to pass through a tube of soda-lime.

Preparation of Standard Baryta Solutions.—First prepare a clear, saturated solution of barium hydroxide in the following manner. Boil, in a flask, about 250 to 300 c.c. of distilled water with excess of barium hydroxide (about 30 to 40 gm.), so as to obtain a saturated solution, and then fit into the neck of the flask C (Fig. 51), a cork carrying a soda-lime tube, and a longer glass tube E. At this stage, the tube should be drawn through the cork, so that the lower end does not dip into the solution, and the upper end should be closed by a cap. When the solution becomes cold, the excess of baryta will crystallize out, and will drag down with it the suspension of barium carbonate, leaving a clear solution, which will have a strength of about 0.4 normal.

Procure a Winchester quart or other bottle, A, capable of holding, say, 2 litres of solution, and fit it with a paraffined cork or india-rubber stopper, bored with two holes. Through one of these pass the end of a soda-lime tube, and through the other a bent glass tube, one end of which reaches nearly to the bottom of the bottle, while the other end is connected by means of india-rubber tubing, carrying a spring clip, to the side tube of the burette B. The upper end of the burette is closed by an air-tight cork through which passes a soda-lime tube, D, fitted with rubber tubing carrying a glass mouthpiece. The burette may be clamped free from the bottle in an ordinary burette or retort clamp, or may be, very conveniently, fixed to the bottle by means of an Ostwald burette clamp (Fig. 52). The wider ring is clamped round the neck of the bottle, while the smaller ring holds the burette.

Having closed the lower end of the burette, attach the

soda-lime tube on A to a filter pump, and draw a current of air (freed from carbon dioxide by means of the soda-lime)

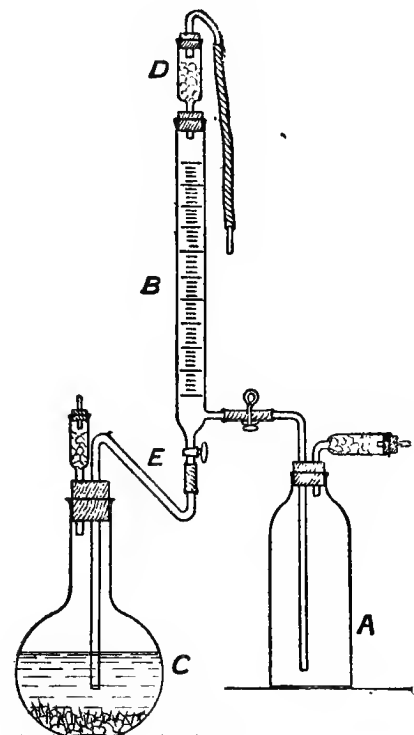

FIG. 51.



FIG. 52.

through the burette and bottle for about 10 minutes. Now close the tube D and draw into the bottle, through the lower end of the burette, about $1\frac{1}{2}$ litres of distilled water, free from carbon dioxide (p. 161, or the water may be freed from carbon dioxide in this bottle). Connect the end of the tube E with the lower end of the burette; attach the soda-lime tube on C to a filter-pump, and draw a current of CO_2 -free air through D, the tube connecting the burette with the bottle A being meanwhile closed. After the tube E has been freed from carbon dioxide, the current of air is stopped, and the tube E is carefully pushed through the cork until the lower end is just a little above the solid baryta at the bottom of the flask C. Tube D is now closed, the connection between the burette and the bottle A is opened, and the clear solution of baryta is drawn into A. The flask with the baryta is then disconnected from the burette, and the solution in the bottle thoroughly mixed by drawing a current of CO_2 -free air through the solution. The solution thus prepared is approximately $\frac{1}{20}$ normal. It is best standardized by means of pure succinic acid, phenolphthalein being used as indicator.

If the burette does not have a side tube, the bottle should be connected with the lower end of the burette, and the tube E with the upper end. The necessary modification in the manipulation will be quite clear.

CHAPTER IX

CONDUCTIVITY OF ELECTROLYTES

WHEN a current of electricity flows through a uniform conductor ab , the *strength* or intensity of the current depends on the *difference of potential* between the two points a and b , and the *resistance* of the conductor; and according to Ohm's law, it is equal to the difference of potential divided by the resistance,

i.e. $i = \frac{e}{r}$. When the current is measured in *amperes*, the

difference of potential in *volts*, and the resistance in *ohms*, we obtain the definition that one ampere is the strength of current produced in a conductor which has a resistance of 1 ohm, and between the ends of which there is a difference of potential of 1 volt.

We may further define these factors. The resistance of 1 ohm is the resistance offered by 14.4521 gm. of mercury at 0° when in the form of a uniform cylinder 106.3 cm. long, having a section, therefore, of practically 1 sq. mm. The strength of current of 1 amp. is obtained when 1 coulomb of electricity, *i.e.* an amount of electricity capable of depositing 0.001118 gm. of silver, passes a point in the conductor each second. Finally, when a current of 1 coul. per second is passing through a column of mercury 106.3 cm. long and 1 sq. mm. cross section, the difference of potential at the two ends of the mercury column will be 1 volt.

The unit of electrical energy is 1 volt \times 1 coul. = 10^7 ergs;

but the strength of the current, and therefore also the amount of electricity flowing in unit time, depend on the resistance, or on the conductance, which is the reciprocal of the resistance. It will therefore be seen that the amount of energy conveyed through a conductor will depend on the difference of potential between its ends and on its resistance or conductance. We shall therefore consider the measurement of these two factors; taking first, the measurement of conductance or resistance.

The resistance offered by a regular cube of the conductor having sides 1 cm. long, is called the *specific resistance* or *resistivity* of the material, and the reciprocal of this is called the *specific conductance* or the *conductivity*. We shall represent the latter by κ . Although a knowledge of the conductivity, whether of a metal or of a liquid conductor, is of importance in physics and electro-technics, it is not, in itself, of so much importance in chemistry or physical chemistry, with which we are here chiefly concerned; for in the case of conducting solutions, with which alone we are going to deal, the conductance does not depend on the whole of the material between the electrodes, but only on the solute. When, therefore, we wish to compare different substances with respect to the conductivity which they exhibit in solution, we should compare chemically comparable quantities, *i.e.* equivalent or equimolecular quantities. In this way we obtain the equivalent conductivity and the molecular conductivity. By *equivalent conductivity* is meant the conductance of a solution which contains 1 gm.-equivalent of the solute, when placed between two electrodes of indefinite size and 1 cm. apart. It is represented by Λ , and is numerically equal to the specific conductance or conductivity (κ) multiplied by the volume in cubic centimetres (ϕ) containing 1 gm.-equivalent of solute. That is, $\Lambda = \kappa \cdot \phi$.

By *molecular conductivity* is meant the conductance of a solution containing 1 mole of the solute when placed between

two electrodes of indefinite size and 1 cm. apart. It is represented by $\mu = \kappa \cdot \phi$, where ϕ is the volume in cubic centimetres containing 1 mole of the solute.

Outline of Method and Apparatus.—For the purpose of measuring the resistance of a solution, one usually employs the Wheatstone bridge method, the arrangement of which is shown diagrammatically in Fig. 53.

Since, during the electrolysis of an aqueous solution between platinum electrodes, gases are evolved, and a back electromotive force (polarization e.m.f.) therefore produced, one cannot readily measure the resistance of a liquid conductor by means of a direct current, but must employ an alternating current such as is given by an induction coil. The wires from the secondary circuit of the induction coil, which should be placed at a distance of two or three feet, so that it does not directly affect the telephone, are connected with the ends of the wire *ab*, which is made of platinum, platinum-iridium, or nickelin, and is stretched above a scale divided into millimetres. *R* is a resistance box, and *V* is a conductivity vessel containing the solution to be investigated. In order to determine the position of balance, a telephone is inserted between the sliding contact *c* and the junction of the resistance box with the conductivity vessel. (In actual practice it is found better to interchange the telephone and induction coil, so that the former is connected with the ends of *ab* and the secondary of the latter connected with the sliding contact and the resistance box. This is shown in Fig. 53.) A resistance is inserted in *R* of the same order as that in the conductivity vessel, and the sliding contact *c* is moved along the wire *ab*

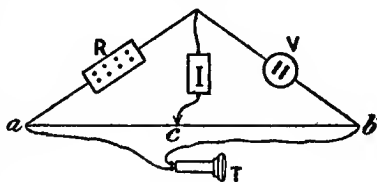

FIG. 53.

until there is silence in the telephone. When this is the case, then the resistance of V is given by the expression—

$$R : V = ac : cb; \text{ or } V = R \cdot \frac{cb}{ac}$$

We have just said that a position on the bridge wire ab must be sought at which there is silence in the telephone, but, as a matter of fact, a position of complete silence will rarely if ever be found. One has therefore to determine the position of *minimum sound*, and this is best done by finding two points, one on either side of the minimum, at which the sound becomes equally intense. The distance of these two points apart, and therefore the sharpness with which the point of balance can be determined, depend on various factors such as the resistance of the solution, the size of the electrodes, their distance apart, and the nature of their surface. With solutions of medium conductivity, however, it should be easily possible to find two points of equal loudness not more than 5 mm. apart, and by repeating the readings several times, it should be possible to determine the mean position of sound minimum with an accuracy of 0.3–0.4 mm. When the minimum cannot be determined with this degree of sharpness, it is generally (except in the case of solutions of very low or very high resistance) an indication that the electrodes require replatinizing (see below).

The *induction coil* should be a small one, so that the amount of electricity which passes at each pulse, and therefore the polarization produced, is small. The “hammer,” also, should be a light one, so that it can be made to vibrate rapidly, and thus produce a high-pitched and more readily audible sound. The coil is most conveniently actuated by a single lead accumulator, or by a dry cell, and the strength of current should be so regulated that the sound of the coil is just distinctly audible. For this purpose a sliding resistance may be inserted in the circuit between the cell and the coil; but it is better, especially

when the experiments are to continue for some time, to insert a fixed resistance of thin, insulated manganin wire, the length of which can very soon be determined by trial. The strength of current must be sufficient to secure the continuous vibration of the hammer H (Fig. 54), which effects the "make and break" of the current; the contact being regulated by allowing the current to pass and very slowly turning the screw S in or out while the free end of the hammer is gently "plucked."

The *resistance box* contains a number of wire resistances, the ends of which are attached to brass blocks on the top of the box, electrical connection between these being made by means of brass plugs (Fig. 55). By removing the plugs, resistance is placed in the circuit, the current being then made to pass through the wire. The value of the resistance inserted is marked opposite each plug-hole.

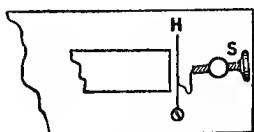

FIG. 54.

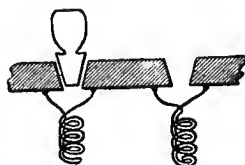

FIG. 55.

Care must be taken that these plugs do not become dirty. When taken out, they should be placed on the top of the box or in the blind holes made for them, and not on the working bench. The plugs should be wiped from time to time with a cloth moistened with petroleum; and when the box is not in use, they should all be inserted in their places.

The *conductivity vessel* may have various forms, according to the liquid for which it is to be used. The two forms which come most generally into use are shown in Fig. 56. They consist of cylindrical glass vessels, either of uniform diameter or narrowed at the foot, for use with liquids of greater conductivity.

The electrodes are circular platinum plates sealed into glass tubes, and electrical connection is made by means of mercury. These two tubes pass through an ebonite cover, and their relative positions must be fixed either by means of a glass tie, or by cementing the tubes to the cover. The cover is also furnished with two holes for the insertion of a thermometer (if desired) and of a pipette (see below). When not in use, these should be closed by means of small corks or rubber plugs.

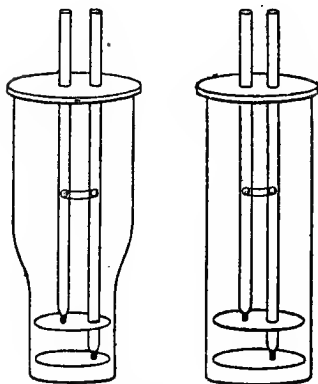

FIG. 56.

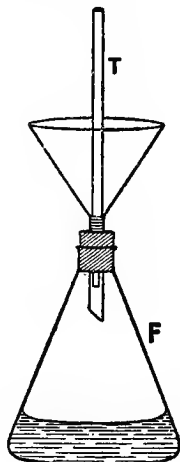

FIG. 57.

The glass vessels are best cleaned and dried by first subjecting them for five or ten minutes to the action of steam, and then drawing a current of air through them by means of a filter pump. A very convenient apparatus for the purpose of steaming out the vessels is shown in Fig. 57. The glass tube T is fitted by means of a piece of rubber tubing into the stem of a funnel which passes through the cork in the neck of the flask F. The vessel to be cleaned is placed over the end of the tube

T, and water is boiled in the flask. The steam passes up through the tube, and the condensed steam collects in the funnel.

Platinizing the Electrodes.—The sharpness with which the sound minimum can be determined, depends largely on the nature of the surface of the electrodes, and is increased by coating these with platinum black. This is best done electrolytically.

A quantity of platinizing solution (3 gm. of platinum chloride, 0.02–0.03 gm. of lead acetate, 100 c.c. water) is placed in the conductivity vessel, and the electrodes, previously cleaned by means of chromic acid lowered into the solution. The vessel should be supported in an inclined position, in order to allow the gas which is evolved during electrolysis to escape readily. The electrodes are connected with a battery of two lead accumulators (4 volts) through a commutator, which allows of the current being reversed. By means of a sliding resistance the current is regulated so that there is only a moderately rapid evolution of gas. The current should be passed for 10–15 minutes, its direction being reversed every half-minute. The coating should be black and velvety in appearance.

A suitable form of commutator is shown in Fig. 58. It consists of a block of wood or paraffin wax furnished with six mercury cups and terminals; and it can be used either for directing the current through one or other of two circuits or for reversing the current. When used for the former purpose, the poles of the battery are connected by means of the terminals 2 and 5 with the corresponding mercury cups, and the wires of the two circuits are connected respectively with the terminals 1 and 6, and 3 and 4. By means of a rocking bridge consisting of two T-shaped pieces of copper rod connected by an insulating bar of glass or ebonite, the current can be sent through one or other of the two circuits. When in the position shown in Fig. 58, A, the current, will be sent through the circuit connected with the terminals 3 and 4; and

when the bridge is thrown over so that the ends dip into the mercury cups 1 and 6, the current will be sent through the circuit connected with these.

When the key is to be used for reversing the current, the mercury cups 1 and 4, and 3 and 6 must be connected by two insulated copper wires (Fig. 58, B). The battery

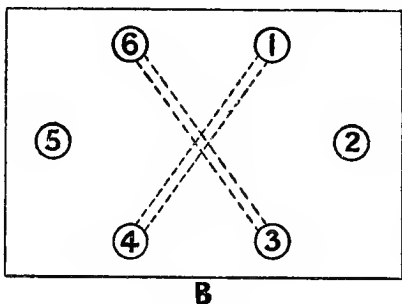
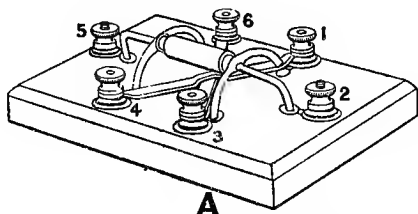

FIG. 58.

is again connected with the terminals 2 and 5 as before, and the circuit through which the current is to be sent, either with the terminals 1 and 6, or 3 and 4. When the ends of the arched portions of the bridge are in the cups 1 and 6, the current will pass in one direction, and when they are in the cups 3 and 4, it will pass in the opposite direction through the circuit. The ends of the rocking bridge should be amalgamated.

On account of the absorbing power of platinum black, the removal of the last traces of platinizing liquid and occluded chlorine sometimes causes difficulty. It can best be effected either by placing the electrodes in a solution of sodium acetate or dilute sulphuric acid and passing a current for about quarter of an hour, with reversal of the current every minute; or by connecting the two electrodes together and making them the cathode in a solution of dilute sulphuric acid, another platinum electrode being employed as anode. In this case the current is, of course, not reversed.

After being treated in this manner, the electrodes are well washed with warm distilled water, and then several times with CO_2 -free water (p. 161), until all soluble matter has been removed (see p. 183).

The Measuring Bridge.—This very commonly consists of a thin wire of platinum, platinum-iridium, or nickelin, stretched over a scale 1 metre long and graduated in millimetres (Fig. 59). A sliding contact, ϵ , having a platinum

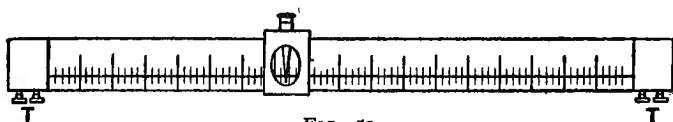

FIG. 59.

knife-edge, makes contact with the wire. At the end of the bridge are terminals T, by means of which electrical contact with the bridge wire can be established.

Since it is possible, in most cases, to arrange that the reading on the bridge wire shall be less than 50–60 cm., the bridge can be made shorter, *while the wire still remains the same length*, the excess of wire being wound on a small drum below the end of the scale.

The position of sound-minimum can be determined most sharply when the sliding contact is near the end of the bridge

wire ; but, on the other hand, an error in the reading near the end of the wire has a greater influence on the result than when the sliding contact is near the middle of the wire. In order, therefore, to balance the errors of setting and of reading, it is best so to arrange the resistances in the box, that the position of balance on the bridge wire lies between 20 and 40, or between 60 and 80 cm.

Calibration of the Bridge Wire.—Before being used, the bridge wire must be calibrated. This is best done by the method of Strouhal and Barus, the arrangement for which is shown diagrammatically in Fig. 60.

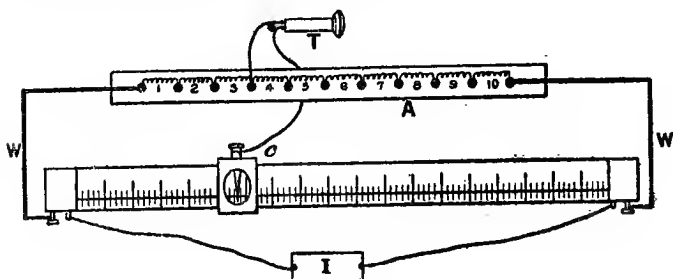

FIG. 60.

The calibration bridge A consists of a strip of wood carrying 11 mercury cups. These cups are connected by 10 approximately equal resistances, the sum of which should be about the same as the total resistance of the bridge wire. These resistances, one of which should be marked differently from the others, are very suitably made of thin manganin wire soldered to thick copper wires, the ends of which, *previously cleaned and amalgamated*,¹ dip into the mercury cups (Fig. 61).

¹ In all measurements of electrical resistance or conductance, whenever connections have to be made by means of copper wires dipping into mercury, one should invariably make it a rule to see that the ends of the copper wires are rubbed quite clean, and, if necessary, freshly amalgamated.

The ends of the calibration bridge are connected by non-resistance wires (thick copper wires), WW, to the ends of the



FIG. 61.

measuring bridge (Fig. 60); and the latter is also connected with the secondary of an induction coil, I. The primary of the latter is connected, if necessary, through a resistance (see p. 168), with a single lead accumulator or other suitable source of current; a switch or other key being inserted in this circuit, and the coil kept in action only while measurements are being made. For this and all other similar purposes, a small electric-light switch-key, mounted on a wooden base with terminals, is very convenient. The sliding contact c is connected with one terminal of a telephone T, while the other terminal is connected with one or other of the mercury cups.

The connections having been made, and the resistance wires placed in position in the calibration bridge, place the lead from the telephone in the second mercury cup from the left end of the calibration bridge, *i.e.* between the first and second resistances. Move the sliding contact c until the position of sound minimum is obtained (see p. 168). The resistance of this length of the measuring wire, which we shall call a , will evidently bear the same relation to the total resistance of the wire, as the resistance r bears to the sum of the ten resistances. Now interchange resistance r with resistance z , the lead from the telephone being still kept in the second mercury cup.¹ Again determine the position of sound minimum,

¹ Since the method of calibration consists in dividing the measuring wire into ten portions of equal resistance, each proportional to the resistance of one of the ten calibration resistances, it is well to have one of the latter specially marked. At the commencement of the calibration, this

and let this reading be b . The resistance of this length of wire will bear the same relation to the total resistance of the bridge wire, as resistance z bears to the sum of the ten resistances.

Now move the lead from the telephone into the third mercury cup, and again determine the position of sound minimum. This point, c , on the bridge wire marks off a resistance which bears the same relation to the total resistance, as the sum of the resistances 1 and z bears to the sum of the ten resistances. By subtracting b from c , a length on the bridge wire is obtained which bears the same relation to the total resistance of the bridge wire as resistance 1 bears to the sum of the ten resistances. That is, the resistance of the length $c - b$ is equal to that of a .

Interchange the resistance 1 with resistance 3 , and again find the position of sound minimum, with the lead from the telephone still in the third mercury cup. This reading, d , will give a length of wire, the resistance of which bears to the total resistance the same relation as the sum of the resistances z and 3 bears to the sum of the ten resistances. Now place the lead from the telephone in cup 4 , and find another position of sound minimum, say e . Then it follows, as before, that $e - d$ is equal to a .

The measurements are continued in this way along the bridge until the resistance 1 has successively occupied the place of each of the others, and has reached the right-hand end of the calibration bridge. The last position of sound-minimum (in the neighbourhood of 90 cm.) is determined with the lead from the telephone in the tenth mercury cup, and this reading is subtracted from 100 to give the final length of the bridge wire equal to a . By this method, the bridge wire has been divided into 10 equal resistances, each of which is equal, or approximately equal, to one-tenth of the whole resistance.

special resistance must be placed at the extreme left of the calibration bridge; it is the resistance which we have numbered 1 .

The ten lengths are added together, and the difference of the sum from 100 taken. One-tenth of this difference is then subtracted from (or added to) each of the a values, so that these now add up to 100. The corrected value of a_1 then gives the length corresponding with 10 cm. of the bridge wire; $a_1 + a_2$, that corresponding with 20 cm. of the bridge wire, etc. The differences of $a_1, a_1 + a_2$, etc., from 10, 20, etc., give the corrections to be applied at these points of the bridge wire. The correction to be applied at an intermediate point is obtained by interpolation, which is best carried out graphically as in the case of the calibration of a burette (p. 37).

The following table, giving the values actually obtained for one wire, will illustrate the foregoing description:—

No. of reading.	Reading on bridge wire.	Length proportional to resistance \times 1.	Correction to reduce sum of lengths to 100.	Corrected lengths of equal resistance.	Length corresponding with the readings 10, 20, 30, etc., cm. on bridge wire.	Correction in mm. to be applied at the end of each 10 cm.
<i>a</i>	10'05	10'05	- 0'04	10'01	10'01	- 0'1
<i>b</i>	10'12	10'00	- 0'04	9'96	19'97	+ 0'3
<i>c</i>	20'12					
<i>d</i>	19'65	9'95	- 0'04	9'91	29'88	+ 1'2
<i>e</i>	29'60					
<i>f</i>	29'60	10'00	- 0'04	9'96	39'84	+ 1'6
<i>g</i>	39'60					
<i>h</i>	39'53	10'07	- 0'04	10'03	49'87	+ 1'3
<i>i</i>	49'60					
<i>j</i>	49'70	10'10	- 0'04	10'06	59'94	+ 0'6
<i>k</i>	59'80					
<i>l</i>	59'70	10'10	- 0'04	10'06	70'00	0'0
<i>m</i>	69'80					
<i>n</i>	69'73	10'00	- 0'04	9'96	79'96	+ 0'4
<i>o</i>	79'73					
<i>p</i>	79'95	9'97	- 0'04	9'93	89'89	+ 1'1
<i>q</i>	89'92					
<i>r</i>	89'95	10'15	- 0'04	10'11	100'00	
	100'00					
		100'39		99'99		

Instead of using an alternating current for calibrating the bridge wire, one may also employ a direct current. The connections are the same as those given in the diagram (Fig. 60, p. 174); but the place of the induction coil is taken by a lead, cupron, or other cell, and the telephone is replaced by a galvanometer. A tapping key (p. 221) is inserted in the galvanometer circuit, so that the current can pass through the galvanometer only when the key is depressed. The sliding contact is then moved along the bridge wire until a position is found such that on depressing the tapping key no movement of the galvanometer needle takes place.

In calibrating the short bridge wires, where the scale is only 60 cm. long, the length of wire coiled up at the end of the bridge must first be so adjusted that the middle point of resistance of the wire coincides with the mark 50 on the scale. To ascertain whether or not this is the case, the ends of the measuring bridge are connected, as described previously (p. 175), with the ends of the calibration bridge; the lead from the telephone is placed in the sixth mercury cup, so that the resistance on either side of it is nearly the same (five resistances on one side and five on the other).¹ The point of balance on the bridge wire is then determined; call it a_1 . Now reverse the calibrating bridge, so that the five resistances which were previously to the right of the telephone lead, are now to the left of it. Again find the position of balance on the measuring wire; call it a_2 . Then the resistance middle point of the bridge wire is given by $\frac{a_1 + a_2}{2}$. If this is not 50, loosen the clamp which fixes the end of the bridge wire at the end of the scale, and either lengthen or shorten the wire, until, on testing in the manner just described, the resistance middle point coincides with mark 50 on the scale.

¹ One can also replace the two sets of five resistances by two single approximately equal resistances.

When this has been done, the calibration is carried out in exactly the same manner as described for the metre bridge (p. 175), except that only the readings $a-h$ are taken, and h subtracted from 50.00. The different values are then corrected so as to add up to 50, and the corrections determined as before.

Conductivity Water.—On account of the sensitiveness of the conductivity method, it is necessary to use water of a high degree of purity. The purest water which has so far been obtained had a specific conductance of 0.4×10^{-7} mhos (reciprocal ohms) at 18° ; but for most purposes, except those demanding the highest degree of accuracy, water having a conductivity of $2-3 \times 10^{-6}$ mhos will be sufficiently pure. Water having a conductivity greater than $3-4 \times 10^{-6}$ mhos should not be employed. Since the two chief causes of the increased conductivity are ammonia and carbonic acid, the ease with which satisfactory conductivity water can be obtained will depend to some extent on the quality of water with which we start. Occasionally the ordinary distilled water of the laboratory is sufficiently good; and where it is not, water of the desired degree of purity can frequently be obtained by redistillation, with rejection of the first and last thirds of the distillate. This redistillation must be carried out in an atmosphere free from fumes, and best in the open air; and the distillation should not be carried out too rapidly. The condenser is best made of block tin, but a tube of Jena or "resistance" glass can also be used with good result. It is well, also, to insert a trap between the still and the condenser, so as to retain, as far as possible, portions of the liquid which may be carried over by the steam. A suitable form of trap is shown in Fig. 62. It consists of a piece of fairly wide glass tubing, A, to which a side tube, drawn out to a capillary point, is attached. Through this side tube the water which collects in the trap passes out.

A good conductivity water can also be obtained from a

lower quality of water by treating the latter for several hours with potassium permanganate acidified with sulphuric acid. It

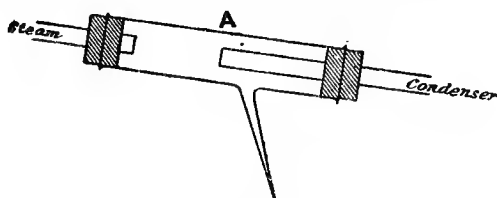

FIG. 62.

is then distilled, and the distillate is treated with baryta and again distilled.

Water which has been distilled in air always contains carbonic acid derived from the atmosphere. This can be removed, and the conductivity of the water thereby somewhat improved, by drawing CO_2 -free air through the water (p. 161).

The water so prepared should be kept in a flask or bottle fitted with a paraffined cork, through which pass a siphon tube and a tube containing soda-lime. Since water dissolves an appreciable amount of matter from ordinary glass, the flask or bottle in which the conductivity water is stored should either have been thoroughly "seasoned," or should be made of a sparingly soluble glass, *e.g.* Jena glass.

The Cell Constant.—The specific conductance or conductivity, we have seen, is the conductance of 1 cm. cube (*not* 1 c.c.) of the material. If, therefore, the electrodes of the conductivity vessel are not exactly 1 sq. cm. in area and 1 cm. apart, the measured resistance or conductance of a solution placed between them will have to be multiplied by a factor, in order to reduce the value to that which would be obtained if the electrodes enclosed between them 1 cm. cube of the liquid. This factor, which depends on the size and shape of the electrodes, and on their distance apart, is known as the *resistance*

capacity of the cell or the *cell constant*. It will be evident that if C is the specific conductance and c the measured conductance, then the cell constant $K = \frac{C}{c}$.

The value of the cell constant can be most easily obtained by measuring the conductance c of a liquid of known conductivity. The liquid which is commonly used for this purpose is a $\frac{n}{50}$ solution of potassium chloride.¹ The conductivity of this solution, expressed in reciprocal ohms or mhos, is as follows—

Temperature.	Conductivity.
10°	1.996×10^{-3}
18°	2.399×10^{-3}
25°	2.768×10^{-3}

EXPERIMENT.—*Determine the Cell Constant of the given Cell.*

Fit up a thermostat and regulate its temperature at 25.0°. Since the temperature has a great influence on the conductivity of a solution, viz. about 2 per cent. per degree, the thermostat must be regulated so that the fluctuation of temperature does not exceed 0.05°–0.1° (p. 71). Arrange the apparatus as shown in the diagram (Fig. 53, p. 167). All connections should be made with fairly thick copper wire, so as to have a negligible resistance; and the ends of the wires, where they are attached to metal terminals, must be scraped or rubbed clean with a knife

¹ Such a solution contains $\frac{74.60}{50}$ gm. KCl in a litre at 18°. If the salt is weighed with brass weights, and if we allow for the buoyancy of the air, the apparent weight will be $\frac{74.57}{50}$. The error introduced by neglecting the buoyancy of the air is for the purpose of these experiments negligible.

or emery-paper, and where they make contact with mercury (at the conductivity vessel) they must be amalgamated.

The conductivity cell V is best supported in the thermostat by means of a holder such as is shown in Fig. 63. It consists

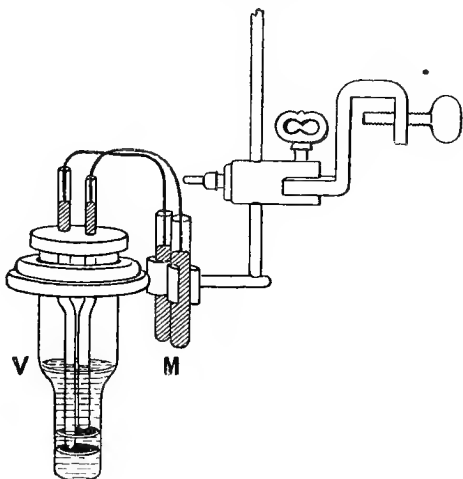

FIG. 63.

of a plate of brass in which a hole is cut large enough to allow the conductivity cell to pass through, the cell being supported by means of a thick rubber ring. Electrical connection between the electrodes and the rest of the apparatus is made by means of fairly stout copper wires, the ends of which (amalgamated) dip, on the one hand, into the mercury in the glass tubes which carry the electrodes, and on the other hand, into two small mercury cups, M, attached to the holder. Into these cups the amalgamated ends of the wires leading to the resistance box and to the bridge wire also dip.

If the electrodes have been freshly platinized, it is necessary, before proceeding to make a measurement, to make sure that

they have been completely freed from soluble substances by determining the resistance of the conductivity water in the cell. If any soluble matter remains in the electrodes it will gradually pass into solution, and thus impart a greater conductivity to the water in the cell ; and as the soluble matter is removed, the conductance of the water will diminish, or the resistance will increase. The electrodes must therefore be washed for such a time that they no longer affect the conductivity of the water. Sufficient water is placed in the cell to cover the electrodes to a depth at least equal to the distance between the two electrodes, and care is taken that no air-bubbles are enclosed between the electrodes.¹ When the water has taken the temperature of the bath, say after 7-10 minutes,² insert a resistance of about 10,000 ohms in the resistance box ; put the induction coil in action, and determine the position of minimum sound on the bridge wire. Empty the cell, and fill it with another sample of the conductivity water, and again determine the resistance in the above manner. If the electrodes were not quite clean, the resistance should now be found greater than before. Again wash out the cell, and determine the resistance of a fresh portion of the conductivity water ; and repeat the operation until a constant value for the resistance of two successive portions of the water is obtained. Owing to the high resistance measured, it will probably be found that the minimum is somewhat indistinct. Several determinations of the minimum position should therefore be made, and the resistance of the water can be taken as constant when the readings on the bridge wire for successive portions of the water do not differ by more than 2-3 mm. Make a note of this reading.

¹ If the electrodes have been allowed to become dry, it is sometimes found that they are not readily moistened. When this is so, first wash the electrodes with alcohol and then rinse in water. It should be made a rule to keep the electrodes, when not in use, in distilled water.

² If the water used has been freed from carbonic acid, it may be found that on longer standing, the resistance begins to diminish, owing to absorption of carbon dioxide from the air.

Having in this way made sure that the electrodes are clean, the cell and electrodes are rinsed several times with a $\frac{1}{50}$ normal solution of pure potassium chloride. A quantity of the solution is then placed in the cell, and allowed to take the temperature of the thermostat. The resistance of the solution is then determined by inserting a certain resistance in the box, and determining the position of sound-minimum on the bridge wire. Keeping in view what was said regarding the accuracy of the readings on the bridge wire (p. 174), the resistance inserted in the box should be so regulated that the readings lie on the middle third of the bridge wire, *i.e.* between the marks 30 and 70 cm.

Several determinations of the resistance of the same sample of solution should be made with different resistances inserted in the box, and in each case several determinations of the position of the sound-minimum made. The cell is then filled with a fresh sample of the solution, and again several determinations of the resistance made, in the manner just described. The value of the cell constant is then calculated from each determination of the resistance, and the mean of the different values taken.

The value of the cell constant is calculated as follows: If R is the resistance inserted in the box, and if the sliding contact at the position of balance divides the bridge wire in the ratio $x : 100 - x$, where x is the bridge reading in centimetres, then the resistance, R' , of the solution is given by $R' = \frac{R \cdot (100 - x)}{x}$. Hence, the conductance, \mathcal{C} , of the solution is $\mathcal{C} = \frac{1}{R'} = \frac{x}{R \cdot (100 - x)}$. If C denote the specific conductance (conductivity) of the solution (p. 166), then the cell constant, K , is given by the expression—

$$K = \frac{C \cdot (100 - x)R}{x}$$

Having now obtained the value of the cell constant, we can calculate the value of the conductivity of the water used, from the determinations of the resistance made above.

If the resistance inserted in the box was R ohms, and if the bridge reading at balance was x cm., then the conductance c' is equal to $\frac{x}{R(100-x)}$. But if K is the cell constant, the conductivity, κ , of the water is given by $\kappa = K \cdot c' = \frac{K}{R} \cdot \frac{x}{(100-x)}$.

The values of the fraction $\frac{x}{100-x}$, for values of x from 0.1-99.9 cm., can be obtained from the following table compiled by Obach:—

TABLES OF VALUES OF $\frac{x}{100-x}$, FOR $x = 0.1-99.9$ cm.

x	0.0	0.1	0.2	0.3	0.4	0.5	0.6	0.7	0.8	0.9
0	0.0000	0010	0020	0030	0040	0050	0060	0071	0081	0091
1	0101	0111	0122	0132	0142	0152	0163	0173	0183	0194
2	0204	0215	0225	0235	0246	0256	0267	0278	0288	0299
3	0309	0320	0331	0341	0352	0363	0373	0384	0395	0406
4	0417	0428	0438	0449	0460	0471	0482	0493	0504	0515
5	0526	0537	0549	0560	0571	0582	0593	0605	0616	0627
6	0638	0650	0661	0672	0684	0695	0707	0718	0730	0741
7	0753	0764	0776	0788	0799	0811	0823	0834	0846	0858
8	0870	0881	0893	0905	0917	0929	0941	0953	0965	0977
9	0989	1001	1013	1025	1038	1050	1062	1074	1087	1099
10	0.1111	1124	1136	1148	1161	1173	1186	1198	1211	1223
11	1236	1249	1261	1274	1287	1299	1312	1325	1338	1351
12	1364	1377	1390	1403	1416	1429	1442	1455	1468	1481
13	1494	1508	1521	1534	1547	1561	1574	1588	1601	1614
14	1628	1641	1655	1669	1682	1696	1710	1723	1737	1751
15	1765	1779	1793	1806	1820	1834	1848	1862	1877	1891
16	1905	1919	1933	1947	1962	1976	1990	2005	2019	2034
17	2048	2063	2077	2092	2107	2121	2136	2151	2166	2180
18	2195	2210	2225	2240	2255	2270	2285	2300	2315	2331
19	2346	2361	2376	2392	2407	2422	2438	2453	2469	2484

x	0'0	0'1	0'2	0'3	0'4	0'5	0'6	0'7	0'8	0'9
20	0'2500	2516	2531	2547	2563	2579	2595	2610	2626	2642
21	2658	2674	2690	2707	2723	2739	2755	2771	2788	2804
22	2821	2837	2854	2870	2887	2903	2920	2937	2953	2970
23	2987	3004	3021	3038	3055	3072	3089	3106	3123	3141
24	3158	3175	3193	3210	3228	3245	3263	3280	3298	3316
25	3333	3351	3369	3387	3405	3423	3441	3459	3477	3495
26	3514	3532	3550	3569	3587	3605	3624	3643	3661	3680
27	3699	3717	3736	3755	3774	3793	3812	3831	3850	3870
28	3889	3908	3928	3947	3967	3986	4006	4025	4045	4065
29	4085	4104	4124	4144	4164	4184	4205	4225	4245	4265
30	0'4286	4306	4327	4347	4368	4389	4409	4430	4451	4472
31	4493	4514	4535	4556	4577	4599	4620	4641	4663	4684
32	4706	4728	4749	4771	4793	4815	4837	4859	4881	4903
33	4925	4948	4970	4993	5015	5038	5060	5083	5106	5129
34	5152	5175	5198	5221	5244	5267	5291	5314	5337	5361
35	5385	5408	5432	5456	5480	5504	5528	5552	5576	5601
36	5625	5650	5674	5699	5723	5748	5773	5798	5823	5848
37	5873	5898	5924	5949	5974	6000	6026	6051	6077	6103
38	6129	6155	6181	6208	6234	6260	6287	6313	6340	6367
39	6393	6420	6447	6475	6502	6529	6556	6584	6611	6639
40	0'6667	6695	6722	6750	6779	6807	6835	6863	6892	6921
41	6949	6978	7007	7036	7065	7094	7123	7153	7182	7212
42	7241	7271	7301	7331	7361	7391	7422	7452	7483	7513
43	7544	7575	7606	7637	7668	7699	7731	7762	7794	7825
44	7857	7889	7921	7953	7986	8018	8051	8083	8116	8149
45	8182	8215	8248	8282	8315	8349	8382	8416	8450	8484
46	8519	8553	8587	8622	8657	8692	8727	8762	8797	8832
47	8868	8904	8939	8975	9011	9048	9084	9121	9157	9194
48	9231	9268	9305	9342	9380	9418	9455	9493	9531	9570
49	9608	9646	9685	9724	9763	9802	9841	9881	9920	9960
50	1'0000	1'0004	1'0008	1'0012	1'0016	1'0020	1'0024	1'0028	1'0033	1'0037
51	1'0041	1'0045	1'0049	1'0053	1'0058	1'0062	1'0066	1'0070	1'0075	1'0079
52	1'0083	1'0088	1'0092	1'0096	1'0101	1'0105	1'0110	1'0114	1'0119	1'0123
53	1'128	1'132	1'137	1'141	1'146	1'151	1'155	1'160	1'165	1'169
54	1'174	1'179	1'183	1'188	1'193	1'198	1'203	1'208	1'212	1'217
55	1'222	1'227	1'232	1'237	1'242	1'247	1'252	1'257	1'262	1'268
56	1'273	1'278	1'283	1'288	1'294	1'299	1'304	1'309	1'315	1'320
57	1'326	1'331	1'336	1'342	1'347	1'353	1'358	1'364	1'370	1'375
58	1'381	1'387	1'392	1'398	1'404	1'410	1'415	1'421	1'427	1'433
59	1'439	1'445	1'451	1'457	1'463	1'469	1'475	1'481	1'488	1'494

<i>x</i>	0'0	0'1	0'2	0'3	0'4	0'5	0'6	0'7	0'8	0'9
60	1'500	1'506	1'513	1'519	1'525	1'532	1'538	1'545	1'551	1'558
61	1'564	1'571	1'577	1'584	1'591	1'597	1'604	1'611	1'618	1'625
62	1'632	1'639	1'646	1'653	1'660	1'667	1'674	1'681	1'688	1'695
63	1'703	1'710	1'717	1'725	1'732	1'740	1'747	1'755	1'762	1'770
64	1'778	1'786	1'793	1'801	1'809	1'817	1'825	1'833	1'841	1'849
65	1'857	1'865	1'874	1'882	1'890	1'899	1'907	1'915	1'924	1'933
66	1'941	1'950	1'959	1'967	1'976	1'985	1'994	2'003	2'012	2'021
67	2'030	2'040	2'049	2'058	2'067	2'077	2'086	2'096	2'106	2'115
68	2'125	2'135	2'145	2'155	2'165	2'175	2'185	2'195	2'205	2'215
69	2'226	2'236	2'247	2'257	2'268	2'279	2'289	2'300	2'311	2'322
70	2'333	2'344	2'356	2'367	2'378	2'390	2'401	2'413	2'425	2'436
71	2'448	2'460	2'472	2'484	2'497	2'509	2'521	2'534	2'546	2'559
72	2'571	2'584	2'597	2'610	2'623	2'636	2'650	2'663	2'676	2'690
73	2'704	2'717	2'731	2'745	2'759	2'774	2'788	2'802	2'817	2'831
74	2'846	2'861	2'876	2'891	2'906	2'922	2'937	2'953	2'968	2'984
75	3'000	3'016	3'032	3'049	3'065	3'082	3'098	3'115	3'132	3'149
76	3'167	3'184	3'202	3'219	3'237	3'255	3'274	3'292	3'310	3'329
77	3'348	3'367	3'386	3'405	3'425	3'444	3'464	3'484	3'505	3'525
78	3'545	3'566	3'587	3'608	3'630	3'651	3'673	3'695	3'717	3'739
79	3'762	3'785	3'808	3'831	3'854	3'878	3'902	3'926	3'950	3'975
80	4'000	4'025	4'051	4'076	4'102	4'128	4'155	4'181	4'208	4'236
81	4'263	4'291	4'319	4'348	4'376	4'405	4'435	4'465	4'495	4'525
82	4'556	4'587	4'618	4'650	4'682	4'714	4'747	4'780	4'814	4'848
83	4'882	4'917	4'952	4'988	5'024	5'061	5'098	5'135	5'173	5'211
84	5'250	5'289	5'329	5'369	5'410	5'452	5'494	5'536	5'579	5'623
85	5'667	5'711	5'757	5'803	5'849	5'897	5'944	5'993	6'042	6'092
86	6'143	6'194	6'246	6'299	6'353	6'407	6'463	6'519	6'576	6'634
87	6'692	6'752	6'813	6'874	6'937	7'000	7'065	7'130	7'197	7'264
88	7'333	7'403	7'475	7'547	7'621	7'696	7'772	7'850	7'929	8'009
89	8'091	8'174	8'259	8'346	8'434	8'524	8'615	8'709	8'804	8'901
90	9'000	9'101	9'204	9'309	9'417	9'526	9'638	9'753	9'870	9'989
91	10'11	10'33	10'36	10'49	10'63	10'77	10'90	11'05	11'20	11'35
92	11'50	11'66	11'82	11'99	12'16	12'33	12'51	12'70	12'89	13'08
93	13'29	13'49	13'71	13'93	14'15	14'38	14'63	14'87	15'13	15'39
94	15'67	15'95	16'24	16'54	16'86	17'18	17'52	17'87	18'23	18'61
95	19'00	19'41	19'83	20'28	20'74	21'22	21'73	22'26	22'81	23'39
96	24'00	24'64	25'32	26'03	26'78	27'57	28'41	29'30	30'25	31'26
97	32'33	33'48	34'71	36'04	37'46	39'00	40'67	42'48	44'45	46'62
98	49'00	51'6	54'6	57'8	61'5	65'7	70'4	75'9	82'3	89'9
99	99'0	110	124	142	166	199	249	332	499	999

EXPERIMENT.—*Determine the Molecular Conductivity and the Dissociation Constant of an Acid.*

The apparatus remains the same as in the preceding experiment. The conductivity cell and electrodes must be cleaned and dried. This is best effected, in the case of the former, by the method given on p. 170, and in the case of the latter, by rinsing them well with water, removing most of the water by placing a piece of filter paper against the *edges* of the electrodes, and then drying by waving the electrodes backwards and forwards in the hot air above a Bunsen flame.

Now prepare 50 or 100 c.c. of a $\frac{1}{18}$ molar solution of the pure acid. If the latter cannot be weighed, e.g. acetic acid, the strength of the solution must be determined by titration with a standard solution of baryta (p. 162), using phenolphthalein as indicator. Further, two pipettes must be obtained and calibrated, one to *deliver*, the other to *take up*, 10 c.c. (p. 35). When not in use, these pipettes should be placed in an upright position, with their ends resting on filter paper.

Into the conductivity vessel, fixed in the thermostat, introduce 20 c.c. of the acid solution with the delivery pipette, and after the solution has taken the temperature of the bath, determine the resistance of the solution, as described in the preceding experiment; readings being taken, as before, with three different resistances in the box.

Having taken a set of readings for the resistance of the solution, withdraw 10 c.c. of the solution with the withdrawal pipette, and introduce 10 c.c. of conductivity water with the delivery pipette;¹ mix the solution well by moving the electrodes up and down, but be careful not to deform the electrodes or to alter their relative positions, and also see that no air-bubbles

¹ A sufficient quantity (say 100-200 c.c.) of water should be kept in a stoppered flask in the thermostat, so that there need be no delay in waiting for the solutions to take the temperature of the bath after addition of water.

are enclosed between them. After having determined the resistance of this second solution, which is only half as concentrated as the first, in the same manner as before, again withdraw 10 c.c. of the solution and add 10 c.c. of water. Determine the resistance of this third solution. Proceed in this manner until the dilution reached is 1024 litres (*i.e.* 1 mole in 1024 litres).

In carrying out the dilution it is not necessary to remove the cover from the conductivity vessel, but the pipettes are inserted through the hole in the cover provided for the purpose. To prevent the accidental displacement of the electrodes by the end of the pipettes, a small india-rubber ring should be slipped over the latter to prevent the pipette from passing too far through the hole in the cover.

The results obtained should be controlled by a second series of determinations, carried out in the same manner with a fresh portion of the initial solution.

In order not to introduce carbon dioxide into the solution from the breath, it is better not to expel the last drop of water from the pipette by blowing, but by closing the upper end of the pipette with the finger and grasping the bulb of the pipette in the hand. The expansion of the air then forces the liquid out of the pipette. If, however, the other method is preferred, then a soda-lime tube must be attached to the end of the pipette.

Calculation.—The specific conductance, κ , of the solution is given, as we have seen, by $\kappa = \frac{K}{R} \cdot \frac{x}{100 - x}$. But the molecular conductivity is equal to $\kappa \cdot \phi$, where ϕ is the volume in cubic centimetres in which 1 mole is dissolved. Hence, the molecular conductivity is given by $\mu = \kappa \cdot \phi = \frac{K \cdot \phi}{R} \cdot \frac{x}{100 - x}$.

The value of the fraction $\frac{x}{100 - x}$ can again be obtained from the table, p. 185.

Arrange your results under the headings ϕ , R , x , μ .

Suitable acids for this experiment are acetic acid, succinic acid, benzoic acid, mandelic acid. Weak polybasic acids (*e.g.* succinic acid), in the dilutions employed here, act electrically as monobasic acids, *i.e.* only one hydrogen atom is ionized.

Degree of Ionization and Ionization Constant.—

Since the conductivity of a solution depends on the concentration of the ions, the degree to which a dissolved electrolyte is ionized can be determined from the conductivity of the solution. If the molecular conductivity at dilution ϕ is represented by μ_ϕ , and that at infinite dilution by μ_∞ , then the degree of ionization, α , is given by $\alpha = \frac{\mu_\phi}{\mu_\infty}$. If, therefore, we know the value of μ_∞ ,¹ and determine, in the manner described, the value of μ_ϕ , we can obtain the value of α .

In the case of weak binary electrolytes, it was shown by Ostwald that the equilibrium between unionized molecules and ions obeys the law of mass action. If, therefore, α is the degree of ionization, $(1 - \alpha)$ will represent the unionized portion. If v is the volume in litres containing 1 gm.-equivalent, the application of the law of mass action gives us (since $\frac{\alpha}{v}$ and $\frac{1 - \alpha}{v}$ represent the concentrations of ions and unionized molecules respectively)—

$$\frac{\alpha^2}{(1 - \alpha)v} = \frac{\mu_\phi^2}{\mu_\infty(\mu_\infty - \mu_\phi)v} = k$$

where k is the dissociation or ionization constant, or, in the case of acids and bases, the so-called affinity constant. Since this number is generally very small, it is usual to employ the hundred-fold greater value $K = 100k$, and to call this the dissociation constant.

¹ In many cases this cannot be determined directly, but must be calculated from the sum of the ionic conductivities.

Calculation.—From the values of μ_ϕ obtained above, calculate the degree of ionization and the ionization constant of the acid investigated.

In making this calculation use may be made of the following values of μ_∞ (for the temperature of 25°). The values of $K = 100k$ are added for comparison :—

Acid.	μ_∞	$K = 100k$
Acetic acid	389	1.8×10^{-5}
Succinic acid	381	6.65×10^{-5}
Benzoic acid	381	6.0×10^{-5}
Mandelic acid	378	4.17×10^{-5}

The calculation of the dissociation constant from the values of α is facilitated by the following table ¹ :—

¹ The position of the decimal point will be easily decided with the help of the following table of values of α and corresponding values of $\frac{\alpha^2}{1-\alpha}$:—

α	$\frac{\alpha^2}{1-\alpha}$
0.0100	0.0001010
0.0312	0.001005
0.0952	0.01002
0.271	0.1007
0.691	1.006
0.917	10.13
0.991	109.1

Suppose, for example, that α has been found equal to 0.451. On looking up the table for the value of $\frac{\alpha^2}{1-\alpha}$ corresponding to this, we find the number 3705. From the above table we see that, for all values of α between 0.271 and 0.691, the values of $\frac{\alpha^2}{1-\alpha}$ lie between 0.1 and 1.0. Hence, the value of $\frac{\alpha^2}{1-\alpha}$ corresponding with the value of $\alpha = 0.451$, is 0.3705.

TABLE OF VALUES OF $\frac{\alpha^2}{1-\alpha}$, FOR VALUES OF α FROM 0.0100-0.999

α	0	1	2	3	4	5	6	7	8	9
0.010	1010	1030	1051	1072	1093	1114	1136	1157	1179	1201
011	1223	1246	1268	1291	1315	1337	1361	1385	1408	1433
012	1457	1482	1507	1532	1557	1582	1608	1633	1659	1686
013	1712	1739	1765	1792	1820	1847	1875	1903	1931	1959
014	1987	2016	2045	2074	2104	2133	2163	2193	2223	2253
015	2284	2314	2345	2376	2408	2440	2473	2505	2537	2569
016	2602	2635	2668	2706	2734	2768	2802	2836	2871	2905
017	2940	2975	3010	3046	3081	3118	3154	3190	3226	3262
018	3299	3336	3373	3411	3449	3487	3525	3563	3602	3641
019	3680	3719	3758	3798	3838	3878	3918	3958	3999	4040
0.020	4082	4123	4164	4206	4248	4290	4333	4376	4418	4461
021	4505	4548	4591	4635	4680	4724	4759	4813	4858	4903
022	4949	4994	5041	5087	5133	5179	5226	5273	5320	5367
023	5415	5462	5510	5558	5607	5655	5704	5753	5802	5852
024	5902	5952	6002	6052	6103	6154	6204	6256	6307	6358
025	6410	6462	6514	6567	6619	6672	6725	6778	6832	6886
026	6940	6995	7049	7104	7159	7213	7269	7324	7380	7436
027	7492	7548	7605	7662	7719	7777	7834	7892	7949	8007
028	8066	8124	8183	8242	8301	8360	8420	8478	8538	8599
029	8661	8721	8782	8844	8905	8966	9028	9090	9152	9215
0.030	9278	9341	9404	9467	9531	9595	9659	9723	9788	9852
031	9917	9982	1005	1011	1017	1025	1031	1038	1044	1051
032	1057	1063	1070	1077	1084	1091	1098	1104	1111	1118
033	1125	1132	1138	1146	1153	1160	1167	1174	1181	1188
034	1196	1204	1212	1219	1226	1233	1241	1248	1255	1263
0.035	1270	1277	1285	1292	1300	1307	1314	1322	1330	1337
036	1345	1352	1360	1368	1375	1383	1391	1398	1406	1414
037	1422	1430	1438	1446	1454	1462	1470	1478	1486	1494
038	1502	1510	1518	1526	1534	1543	1551	1559	1567	1575
039	1583	1592	1600	1608	1616	1625	1633	1642	1650	1658
0.040	1667	1675	1684	1692	1701	1710	1718	1727	1736	1744
041	1753	1762	1770	1779	1788	1797	1805	1814	1823	1832
042	1841	1850	1859	1868	1877	1886	1895	1904	1913	1922
043	1932	1941	1950	1959	1968	1978	1987	1996	2005	2015
044	2024	2034	2043	2053	2062	2071	2081	2090	2100	2110

α	0	1	2	3	4	5	6	7	8	9
0.045	2119	2129	2139	2149	2159	2168	2178	2188	2198	2208
046	2217	2227	2237	2247	2257	2267	2277	2287	2297	2307
047	2317	2327	2337	2347	2357	2368	2379	2389	2399	2409
048	2420	2430	2440	2450	2461	2471	2482	2492	2503	2513
049	2524	2534	2545	2555	2566	2577	2587	2599	2610	2620
0.050	2631	2642	2653	2663	2674	2685	2696	2707	2718	2729
051	2741	2752	2763	2774	2785	2796	2807	2818	2829	2840
052	2852	2863	2874	2885	2897	2908	2919	2931	2942	2953
053	2965	2977	2989	3000	3012	3023	3035	3047	3058	3070
054	3081	3093	3105	3116	3128	3140	3152	3164	3176	3187
055	3199	3211	3223	3235	3248	3260	3272	3284	3296	3308
056	3321	3333	3345	3357	3370	3383	3395	3407	3419	3432
057	3444	3457	3469	3481	3494	3507	3520	3532	3545	3558
058	3570	3583	3595	3608	3621	3634	3647	3660	3673	3686
059	3699	3711	3724	3737	3751	3764	3777	3790	3803	3816
0.060	3830	3843	3856	3870	3883	3896	3910	3923	3936	3950
061	3963	3977	3990	4004	4017	4030	4044	4057	4071	4084
062	4098	4111	4125	4139	4153	4166	4180	4194	4208	4222
063	4236	4250	4264	4278	4292	4306	4320	4334	4348	4362
064	4376	4391	4405	4419	4434	4448	4462	4477	4491	4505
065	4519	4534	4548	4563	4577	4592	4606	4621	4635	4650
066	4664	4679	4694	4708	4723	4738	4752	4767	4782	4796
067	4811	4826	4841	4856	4871	4886	4901	4916	4931	4946
068	4961	4976	4992	5007	5023	5038	5054	5069	5085	5100
069	5115	5130	5146	5161	5177	5192	5208	5223	5239	5254
0.070	5269	5284	5300	5316	5331	5347	5362	5378	5394	5410
071	5426	5442	5458	5474	5490	5506	5522	5538	5554	5570
072	5586	5602	5619	5636	5652	5668	5685	5701	5717	5733
073	5749	5766	5782	5799	5815	5832	5848	5865	5881	5898
074	5914	5931	5947	5964	5981	5997	6014	6031	6047	6064
075	6081	6098	6115	6132	6149	6166	6183	6200	6217	6234
076	6251	6268	6286	6303	6320	6338	6355	6372	6390	6407
077	6424	6442	6459	6477	6494	6512	6529	6547	6564	6582
078	6599	6617	6634	6652	6670	6687	6705	6723	6740	6758
079	6776	6794	6812	6829	6847	6865	6883	6901	6919	6937
0.080	6955	6973	6992	7010	7029	7047	7066	7084	7103	7121
081	7139	7158	7176	7197	7215	7234	7252	7270	7288	7307
082	7325	7344	7362	7381	7400	7418	7437	7456	7474	7495
083	7513	7532	7551	7570	7589	7608	7627	7646	7665	7684
084	7703	7722	7741	7761	7780	7799	7819	7838	7857	7876

	0	1	2	3	4	5	6	7	8	9
0·085	7896	7916	7935	7955	7975	7994	8014	8033	8053	8072
086	8092	8112	8131	8151	8171	8190	8210	8230	8250	8270
087	8290	8310	8330	8350	8370	8391	8411	8431	8451	8471
088	8491	8511	8532	8552	8572	8593	8613	8633	8654	8674
089	8695	8715	8736	8757	8777	8798	8819	8839	8860	8881
0·090	8901	8922	8942	8963	8984	9005	9026	9047	9068	9089
091	9110	9131	9152	9173	9195	9216	9237	9258	9280	9301
092	9322	9343	9365	9386	9408	9429	9451	9472	9494	9515
093	9536	9557	9579	9601	9622	9644	9666	9687	9709	9731
094	9753	9775	9796	9818	9840	9862	9884	9906	9928	9950
095	9972	9994	1002	1004	1006	1008	1011	1013	1015	1017
096	1020	1022	1024	1027	1029	1031	1033	1036	1038	1040
097	1042	1044	1047	1049	1051	1054	1056	1058	1060	1063
098	1065	1067	1069	1072	1074	1076	1079	1081	1083	1086
099	1088	1090	1092	1095	1097	1099	1101	1104	1106	1109
0·10	1111	1135	1159	1183	1207	1232	1257	1282	1308	1333
11	1360	1386	1413	1440	1467	1494	1522	1550	1579	1607
12	1636	1666	1695	1725	1755	1786	1817	1848	1879	1911
13	1943	1975	2007	2040	2073	2107	2141	2175	2209	2244
14	2279	2314	2350	2386	2422	2459	2496	2533	2571	2609
15	2647	2686	2725	2764	2803	2843	2883	2924	2965	3006
16	3048	3090	3132	3174	3217	3261	3304	3348	3392	3437
17	3482	3527	3573	3619	3665	3712	3759	3807	3855	3903
18	3951	4000	4049	4099	4149	4199	4250	4301	4353	4403
19	4457	4509	4562	4616	4670	4724	4778	4833	4888	4944
0·20	5000	5056	5113	5171	5228	5286	5345	5403	5463	5522
21	5582	5643	5704	5765	5826	5889	5951	6014	6077	6141
22	6205	6270	6335	6400	6466	6532	6599	6666	6734	6802
23	6870	6939	7008	7078	7148	7219	7290	7362	7434	7506
24	7579	7652	7726	7800	7875	7950	8026	8102	8179	8256
25	8333	8411	8490	8569	8648	8728	8809	8890	8971	9053
26	9135	9218	9301	9385	9470	9554	9640	9726	9812	9899
27	9986	1007	1016	1025	1034	1043	1052	1061	1070	1080
28	1089	1099	1108	1117	1127	1136	1146	1155	1165	1175
29	1185	1194	1204	1214	1224	1234	1245	1255	1265	1275
0·30	1286	1296	1307	1317	1328	1339	1349	1360	1371	1382
31	1393	1404	1415	1426	1437	1449	1460	1471	1483	1494
32	1506	1518	1529	1541	1553	1565	1577	1589	1601	1613
33	1625	1638	1650	1663	1675	1688	1700	1713	1726	1739
34	1752	1765	1778	1791	1804	1817	1831	1844	1857	1871

CONDUCTIVITY OF ELECTROLYTES

195

a	o	1	2	3	4	5	6	7	8	9
0.35	1885	1898	1912	1926	1940	1954	1968	1982	1996	2011
36	2025	2040	2054	2068	2083	2098	2113	2128	2143	2158
37	2173	2188	2203	2219	2234	2250	2266	2281	2297	2313
38	2329	2345	2361	2378	2394	2410	2427	2443	2460	2477
39	2493	2510	2527	2545	2562	2579	2596	2614	2631	2649
0.40	2667	2685	2702	2720	2739	2757	2775	2793	2812	2830
41	2849	2868	2887	2906	2925	2944	2963	2983	3002	3022
42	3041	3061	3081	3101	3121	3141	3162	3182	3203	3223
43	3244	3265	3286	3307	3328	3349	3371	3392	3414	3435
44	3457	3479	3501	3523	3546	3568	3591	3613	3636	3659
45	3682	3705	3728	3752	3775	3799	3822	3846	3870	3894
46	3919	3943	3967	3992	4017	4042	4067	4092	4117	4142
47	4168	4194	4219	4245	4271	4298	4324	4351	4377	4404
48	4431	4458	4485	4512	4540	4568	4595	4613	4651	4680
49	4708	4736	4765	4794	4823	4852	4881	4911	4940	4970
0.50	5000	5030	5060	5091	5121	5152	5183	5214	5245	5277
51	5308	5340	5372	5404	5436	5469	5501	5534	5567	5600
52	5633	5667	5701	5734	5768	5803	5837	5871	5906	5941
53	5977	6012	6048	6083	6119	6155	6192	6228	6265	6302
54	6339	6377	6414	6452	6490	6528	6566	6605	6644	6683
0.55	6722	6762	6801	6841	6882	6922	6963	7003	7044	7086
56	7127	7169	7211	7253	7296	7339	7382	7425	7468	7512
57	7556	7600	7645	7689	7734	7779	7825	7871	7917	7963
58	8010	8056	8103	8151	8199	8246	8295	8343	8392	8441
59	8490	8540	8590	8640	8691	8741	8792	8844	8896	8948
0.60	9000	9053	9106	9159	9213	9267	9321	9375	9430	9485
61	9541	9597	9653	9710	9767	9824	9882	9940	9998	1006
62	1012	1018	1024	1030	1036	1042	1048	1054	1060	1066
63	1073	1079	1085	1092	1098	1105	1111	1118	1124	1131
64	1138	1145	1151	1158	1165	1172	1179	1186	1193	1200
65	1207	1214	1222	1229	1236	1244	1251	1258	1266	1274
66	1281	1289	1297	1304	1312	1320	1328	1336	1344	1352
67	1360	1369	1377	1385	1393	1402	1410	1419	1428	1436
68	1445	1454	1463	1473	1482	1491	1499	1508	1517	1526
69	1536	1545	1555	1564	1574	1583	1593	1603	1613	1623
0.70	1633	1643	1654	1664	1674	1685	1695	1706	1717	1727
71	1738	1749	1760	1771	1783	1794	1805	1817	1828	1840
72	1851	1863	1875	1887	1899	1911	1924	1936	1949	1961
73	1974	1987	1999	2012	2025	2039	2052	2065	2079	2092
74	2106	2120	2134	2148	2162	2177	2191	2206	2220	2235

a	0	1	2	3	4	5	6	7	8	9
0·75	2250	2265	2280	2296	2311	2327	2342	2358	2374	2390
76	2407	2423	2440	2456	2473	2490	2508	2525	2542	2560
77	2578	2596	2614	2632	2651	2669	2688	2707	2727	2746
78	2766	2785	2805	2825	2846	2866	2887	2908	2929	2950
79	2972	2994	3016	3038	3060	3083	3106	3129	3153	3176
0·80	3200	3224	3249	3273	3298	3323	3348	3374	3400	3427
81	3453	3480	3507	3535	3562	3590	3619	3648	3677	3706
82	3736	3766	3796	3827	3858	3889	3921	3953	3986	4019
83	4052	4086	4120	4155	4190	4225	4262	4298	4335	4372
84	4410	4448	4487	4526	4566	4606	4648	4689	4731	4773
85	4816	4860	4905	4950	4995	5042	5088	5136	5184	5233
86	5283	5333	5384	5436	5489	5542	5597	5652	5708	5765
87	5822	5881	5941	6001	6063	6125	6189	6253	6319	6386
88	6453	6522	6593	6664	6737	6811	6886	6963	7041	7120
89	7201	7283	7367	7453	7540	7629	7719	7812	7906	8002
0·90	8100	8200	8302	8406	8513	8621	8732	8846	8962	9080
91	9201	9324	9452	9581	9714	9850	9989	1013	1028	1043
92	1058	1074	1090	1107	1123	1141	1158	1177	1196	1215
93	1236	1256	1277	1299	1321	1345	1369	1393	1419	1445
94	1473	1501	1530	1560	1592	1624	1658	1692	1728	1766
95	1805	1846	1888	1933	1979	2027	2077	2130	2185	2244
96	2304	2368	2436	2506	2582	2660	2744	2833	2928	3029
97	3136	3251	3374	3507	3649	3803	3970	4150	4347	4564
98	4802	5005	5358	5684	6052	6468	6945	7493	8134	8892
99	9801	1091	1230	1409	1647	1980	2480	3313	4980	9980

Basicity of Acids.—It has been found that the difference between the equivalent conductivity of $\frac{n}{32}$ and $\frac{n}{1024}$ solutions of the sodium or potassium salt of an acid is approximately equal to $10 \times B$ units, where B represents the basicity of the acid. To determine the basicity of an acid, therefore, it is only necessary to determine the equivalent conductivity of its sodium salt in a dilution of 32 litres and 1024 litres respectively, and to divide the difference of the values so found by 10. The nearest whole number then represents the basicity of the acid.

EXPERIMENT.—*Determine the Basicity of Succinic Acid.*

For the purpose of this experiment, sodium hydroxide free from carbonate is required. This is best prepared as follows: Metallic sodium in roughly weighed amount, according to the quantity and strength of the solution required, is freed from the adhering paraffin or other liquid, and from the crust of oxide, and placed in the funnel F (Fig. 64), made of nickel

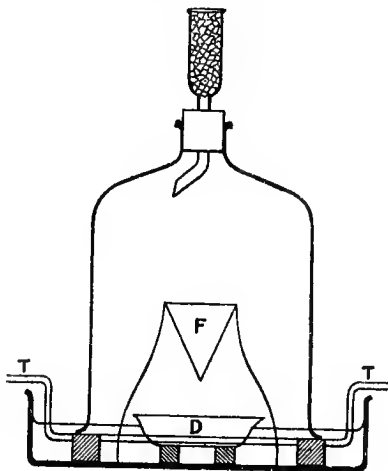

FIG. 64.

gauze. This funnel stands in a basin containing a quantity of water which has been made distinctly alkaline with ordinary caustic soda (more especially if the water contain much carbonic acid in solution), and over all is placed a bell-jar, the neck of which is closed by a cork carrying a soda-lime tube. The end of this tube, which passes into the bell-jar, should be bent so that any moisture which may condense shall not drop on the sodium. Under the apex of the funnel is placed a basin, D, of platinum, silver, or nickel; but this basin should not swim free on the surface of the water, but should be placed on

a glass tripod, porcelain stand, or block of wood (weighted). The metallic sodium is now in an atmosphere free from carbon dioxide and saturated with water vapour. The water vapour acts slowly on the sodium, and a strong solution of sodium hydroxide trickles down into the basin placed under the funnel.

The operation can, if desired, be hastened by passing steam through a coil of lead or compo. tubing, T, placed in the water in the basin. The vaporization of the water is thereby increased, and the action on the sodium accelerated. Care must, however, be exercised, especially if large amounts of sodium are being acted on, that the action does not become too vigorous; and it is advisable to discontinue the passage of steam from time to time, so that the vaporization of the water under the bell-jar does not become excessive.

To prevent the condensed steam from blocking up the heating tube, it is well to connect the exit end of the latter to a filter pump, a condensing bottle being inserted to prevent the possible breaking of the pump by the hot steam.

After all the sodium has been converted to hydroxide, the latter is transferred as rapidly as possible to a bottle containing sufficient distilled CO_2 -free water to make the solution of about the concentration desired. The solution can be standardized by means of succinic acid (the solution of which is also prepared with CO_2 -free water), using phenolphthalein as indicator.

In making up the $\frac{n}{32}$ solution of the salt, one may, if the acid is solid, prepare exactly $\frac{n}{32}$ solution of caustic soda and neutralize this with the solid acid, using a drop of phenolphthalein as an indicator; but in most cases it will probably be found most convenient to have the acid also in solution. In this case the caustic-soda solution must be stronger than $\frac{n}{32}$, and

may suitably be about $\frac{n}{16}$. Having ascertained the titre of the alkali solution, as much of it is run from a burette into a measuring flask as contains the amount of sodium hydroxide required to give a $\frac{n}{32}$ normal solution when diluted to a given volume, say 100 c.c. This is then neutralized carefully by means of the acid solution. The acid must be added carefully, towards the end of the process drop by drop, until the pink colour of the phenolphthalein, added as indicator, just entirely disappears; better a slight excess of acid than of alkali. The solution is now made up to the given volume, say 100 c.c., thus yielding a $\frac{n}{32}$ solution of the sodium salt of the acid. The equivalent conductivity of this solution is determined in the manner previously described. The solution is then diluted by the successive withdrawal of 10 c.c. of the solution and addition of 10 c.c. of water (p. 188), until the concentration is $\frac{1}{1024}$ normal; and the equivalent conductivity at this dilution determined.

Determination of the Neutralization Point by Conductivity.—Measurements of the electrical conductance can also be employed in order to determine the point of neutralization of an acid by an alkali, or *vice versâ*; and the method is of especial importance when dealing with coloured or turbid solutions, in which the change of colour of an indicator would be more or less masked.

When a strong acid is added to an alkali, the conductance of the solution will decrease owing to the disappearance of hydroxidion, and its replacement by the less mobile anion of the acid; but when all the hydroxidion has been removed, by combination with hydrion from the acid added, then any further addition of acid will cause the conductance to increase,

owing to the addition to the solution of free hydrion. Since hydrion has a much greater mobility than any other ion, the presence of a slight excess of free acid will cause a marked increase in the conductance.

EXPERIMENT.—*Determine the Strength of a Solution of Sodium Hydroxide.*

Place a known volume of the solution of caustic soda (free from carbonate) in the conductivity cell, insert a resistance in the box, and determine the point of balance on the bridge wire, exactly as in the preceding measurements. The resistance which is inserted should be such that the bridge reading is about 50 cm. From a burette, run in a standard solution of acid (HCl or H_2SO_4) in small quantities at a time, and after each addition determine the point of balance on the bridge wire, the resistance in the box being kept the same throughout. After each addition of acid, the solution must be well mixed. It will be found that as acid is added to the alkali, the sliding contact must be moved first towards the zero end of the wire, indicating a decrease in the conductance of the solution; and then, after a certain point, must be moved in the opposite direction. Several readings on either side of the turning-point must be obtained.

In order to obtain the strength of the alkali solution, the bridge readings are plotted as ordinates against the number of cubic centimetres of acid added, and curves are drawn through the points so obtained. The point of intersection of the two curves then gives the number of cubic centimetres of acid required to exactly neutralize the solution of alkali (Fig. 65, A).

The result obtained electrically should be controlled by titration, using phenolphthalein as indicator.

If not only the acid, but also the alkali is strong, one may also add the base to the acid. In this case there is first a diminution of the conductance owing to the replacement of

hydrion by a less mobile cation, and then, after the neutral point has been reached, an increase in the conductance, which

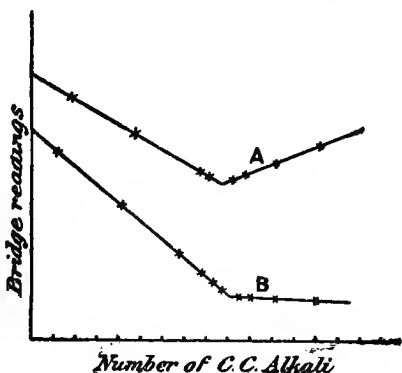

FIG. 65.

is also sharply defined owing to the fact that the OH' is also a highly mobile ion.

When, however, the acid is weak, it is necessary to add the acid to the alkali (*and in this case a strong base must be chosen*), and not the alkali to the acid. If the base is added to a weak acid, the minimum will not be sharp owing to the fact that the change in conductance is due not so much to the disappearance of the fast-moving hydrion (which is present in comparatively small concentration), as to the replacement of the unionized acid molecules by the ions of the salt formed. When, however, the acid is added to the alkali, we get replacement of the hydroxidion by the much slower anion of the acid, and a consequent diminution of the conductance of the solution. As the acid is, however, only slightly ionized, and the ionization is further reduced by the presence of the neutral salt, the addition of excess of acid does not generally lead to an increase of the conductance. In this

case, the neutral point is indicated by a sharp change in the direction of the conductance curves, as shown in Fig. 65, B.

EXPERIMENT.—*Determine the Strength of a Solution of Acetic Acid.*

The experiment is carried out in exactly the same manner as the previous experiment. As solution of acetic acid, one may use crude vinegar (brown), whereby the utility of the method will be rendered more obvious.

Solubility of Sparingly Soluble Salts.—Determinations of the conductivity may also be employed, very advantageously, for the determination of the solubility of sparingly soluble salts.

The equivalent conductivity of a solution is given, as we have seen, by the expression $\Lambda_\phi = \kappa \cdot \phi$, where κ is the specific conductance and ϕ the volume (in c.c.) in which 1 gram-equivalent of solute is dissolved. That is to say, if the saturated solution of a salt contains 1 gram-equivalent in ϕ c.c., the conductivity would be equal to Λ_ϕ ; or, the volume in cubic centimetres containing 1 gram-equivalent of solute will be $\phi = \Lambda_\phi / \kappa$. Λ_ϕ is, however, equal to $\alpha \Lambda_\infty$, where α is the degree of ionisation. Since Λ_∞ is equal to the sum of the ionic conductivities, its value is known; and if α is also known, we can calculate the value of Λ_ϕ . Since we are dealing here with very dilute solutions we may, for our present purpose, regard the ionisation as being complete, and α , therefore, equal to unity.¹ We therefore obtain the expression $\phi = \Lambda_\infty / \kappa$, as the expression for the volume in cubic centimetres containing 1 gram-equivalent of salt, or, the number of gram-equivalents of salt per litre will be given by the expression

$$n = \frac{1000 \cdot \kappa}{\Lambda_\infty}$$

¹ It must be borne in mind that for accurate determinations of the solubility, this assumption cannot be made, and the value of α must be ascertained and introduced in the above expression.

EXPERIMENT.—*Determine the Solubility of Lead Sulphate or of Silver Chloride in Water at 25°.*

The conductivity of the water employed should first be determined at 25°. A quantity of finely powdered lead sulphate or silver chloride is then shaken repeatedly with the conductivity water in order to remove any impurities of a comparatively soluble nature. The well-washed salt is then placed along with conductivity water in a hard-glass vessel, which is placed in a thermostat at 25°, and shaken from time to time. After intervals of about quarter of an hour, a quantity of the solution is transferred to a conductivity cell, and the conductivity determined. This is repeated with fresh samples of the solution, until constant values are obtained.

The conductivity so determined is corrected by subtracting the conductivity of the water employed, and the solubility then calculated by means of the equation, $n = \frac{1000 \cdot \kappa}{\Lambda_{\infty}}$. This gives the number of gram-equivalents of salt in 1 litre of solution (or of water). To obtain the number of gram-molecules per litre, the solubility in gram-equivalents per litre must be divided by the valency of the metal.

The solubility of other sparingly soluble salts can be obtained in a similar manner. The value of Λ_{∞} can be obtained from the sum of the ionic conductivities (see Appendix).

The influence of a common ion in diminishing the solubility of a sparingly soluble salt may also be studied by employing, in place of pure water, dilute solutions ($\frac{n}{1000}$ to $\frac{n}{100}$) of sulphuric acid, in the case of lead sulphate, or of hydrochloric acid, in the case of silver chloride.

Hydrolysis of Salts.—When the salt of a weak acid or base is dissolved in water, hydrolysis occurs, so that the conductance of the solution is now partly due to the ions of

the salt and partly to the ions (more especially the hydrion and hydroxidion) of the acid or base formed by hydrolysis. If, however, a quantity of the weak acid or base which, in the presence of its salt, can be regarded as completely unionised, is added to the solution, the hydrolysis of the salt will be diminished, but the ionisation will be unaffected. From measurements of the conductivity of pure solutions of the salt (in which, therefore, hydrolysis occurs), and of solutions containing excess of the weak base or acid, the degree of hydrolysis can readily be calculated.

Considering here only the simplest case of a binary salt, say of a strong monobasic acid with a weak monoacid base, we have, for the hydrolytic equilibrium, the expression

$$\frac{k_1}{k_2} = \frac{(1-x)v}{x^2}$$

where v is the volume in litres containing 1 gram-molecule of salt; x the degree of hydrolysis; k_1 the affinity constant of the weak base; and k_2 the ionisation constant of water. The amount of the unhydrolysed salt is represented by $(1-x)$, and of the free acid by x . For the equivalent conductivity, Λ_v , of the solution of hydrolysed salt, therefore, we shall have

$$\Lambda_v = (1-x) \Lambda'_v + x \cdot \Lambda''_v$$

where Λ'_v and Λ''_v are the equivalent conductivities at the dilution v litres of the unhydrolysed salt and of the strong acid respectively. The former, as we have seen, can be determined by measuring the equivalent conductivity of the salt in presence of excess of the weak base. The degree of hydrolysis of the salt at the given dilution is then given by the expression

$$x = \frac{\Lambda_v - \Lambda'_v}{\Lambda''_v - \Lambda'_v}$$

EXPERIMENT.—*Determine the Degree of Hydrolysis of Aniline Hydrochloride in Aqueous Solution at 25°.*

Make a solution (say $\frac{n}{32}$) of aniline hydrochloride in water. Place 20 c.c. of this solution in a conductivity cell and determine the conductivity at 25° . Dilute the solution with water to $\frac{n}{64}$ and $\frac{n}{128}$, as described on p. 188, and determine the conductivity at each dilution. Make now a solution of aniline hydrochloride, not in pure water, but in a $\frac{n}{32}$ -solution of aniline, and determine the conductivity at the same dilutions as before, the dilution of the original solution being carried out with the $\frac{n}{32}$ -solution of aniline. From the conductivities so determined, calculate the degree of hydrolysis of aniline hydrochloride at each of the dilutions, the equivalent conductivities of hydrochloric acid at $v = 32, 64$ and 128 , being taken as 393, 399 and 401 respectively.

Calculation.—From the value of the degree of hydrolysis found calculate (1) the affinity constant of aniline, assuming the ionisation constant of water at 25° to be 0.82×10^{-14} (2) the ionisation constant of water, assuming the affinity constant of aniline to be 5.3×10^{-10} .

References.—For preparation of conductivity water: Bourdillon, *Trans. Chem. Soc.*, 1913, 103, 791. For solubility determinations: Böttger, *Zeitschr. physikal. Chem.*, 1903, 46, 521; Kohlrausch, *ibid.*, 1908, 64, 129; Prud'homme, *J. Chem. phys.*, 1911, 9, 517. For hydrolytic determinations: Bredig, *Zeitschr. physikal. Chem.*, 1894, 13, 321; Noyes, Kato and Sosman, *J. Amer. Chem. Soc.*, 1910, 32, 159. For determinations of the velocity of saponification: Walker, *Proc. Roy. Soc.*, 1906, A, 78, 157; Findlay and Hickmans, *Trans. Chem. Soc.*, 1909, 95, 1003.

CHAPTER X

TRANSPORT NUMBERS

WHEN a current of electricity is passed through an electrolyte, it is found that the change of concentration at the two electrodes is, in general, not the same. It follows, therefore, that since equivalent amounts of positive and negative ions are discharged at the two electrodes, the velocity with which the ions move under the fall of potential must be different. From this difference in the velocity of migration of the two ions it follows that since the electricity is carried through the solution by the ions, the amount of electricity carried in one direction by the positive ions, must be different from that carried in the opposite direction by the negative ions; these two amounts being, indeed, in the ratio of the velocities of migration of the cation and anion respectively.

Since the total amount of electricity passed through a solution is proportional to the sum of the velocities, $u + v$, of the cation and anion, it follows that the fraction of the total current carried by the cation is $\frac{u}{u + v}$, and that carried by the anion $\frac{v}{u + v}$. These fractions are known as the *transport number* of the cation and anion respectively (Hittorf). The transport number can therefore be obtained by determining the total amount of electricity which passes through the solution, and the amount of one of the ions which has passed away from the space round one of the electrodes.

In this method of determining the transport number of an ion, it is assumed that change in the concentration takes place

only in the neighbourhood of the electrodes, and that the intermediate portion of the solution remains unaltered. It is evident, therefore, that the current must not be allowed to pass for too long a time. Another reason, also, for limiting the time during which the current passes is that alteration in the composition would otherwise be caused by ordinary diffusion.

EXPERIMENT.—*Determine the Transport Numbers of the Silver Ion and Nitrate Ion in a Solution of Silver Nitrate.*

For this experiment the apparatus shown in Fig. 66 may be employed. The tubes are first filled with a solution of silver nitrate (about $\frac{n}{20}$), the composition *by weight* of which is determined by titration, or by electrolytic deposition. Into the tubes are fixed by means of corks, two silver electrodes made by fixing pieces of thick silver rod to copper wires, and cementing the latter into glass tubes so that only the silver is exposed. The rod to be used as anode should be freshly plated with silver.

As we shall be concerned only with the change in the composition of the solution at the anode, it is not necessary to have a silver cathode; and its place can be taken by a copper electrode. In this case a layer (about 5 cm. in depth) of a strong solution of copper nitrate, slightly acidified with nitric acid, is first introduced into the shorter limb of the apparatus, and the rest of the apparatus then filled with the silver nitrate solution. This must be done carefully so as not to disturb the layer of

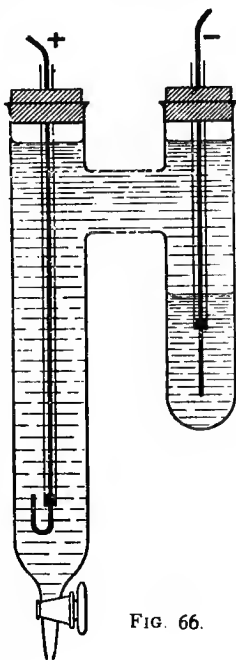

FIG. 66.

copper nitrate. It is most easily accomplished by placing a disc of cork on the top of the copper nitrate solution, and running the silver nitrate solution on to this from a pipette.

The apparatus is now connected with a battery, and a current of about 0.01 or 0.02 amp. sent through the solution.¹ A milliammeter and a copper voltameter, together with a sliding resistance, should also be inserted in the circuit, all in series; the ammeter being used for the approximate regulation of the current, and the voltameter for the determination of the total amount of electricity passed through the solution. The electrical potential which must be employed in order to give a current of about 10 milliamperes will depend, of course, on the resistance, and, therefore, on the dimensions of the apparatus employed. In general, a potential of 30-40 volts will be necessary; and where this cannot be obtained from a battery, one may make use of the electric light circuit, a sufficiently large and adjustable resistance being inserted in the circuit.²

As copper voltameter one may employ a beaker containing a copper solution of the composition given below, in which dip two electrodes, about 1.5 cm. square, cut from copper sheet. The plate to be used as cathode must first be cleaned and weighed; and at the conclusion of the experiment is withdrawn from the solution, washed well with distilled water and with alcohol, dried in the hot air over a flame, and again weighed. While the experiment is in progress, a current of carbon dioxide, washed by bubbling through water, should be passed through the solution.

¹ Sufficiently accurate results can also be obtained with a current of about 7 milliamperes; but too strong a current should not be used on account of the heating effect, and the consequent danger of convection currents causing a mixing of the different layers of solution.

² Such a resistance is most easily obtained by placing two platinum electrodes in a beaker of distilled water, and adding, in drops, a solution of boric acid.

The copper solution should have the following composition :

Copper sulphate	150 gm.
Sulphuric acid	50 „
Alcohol	50 „
Water	1000 „

The same solution can be used repeatedly.

The current is allowed to pass for 2-3 hours, according to the strength of the current employed;¹ and the cathode of the voltameter is then removed and weighed. The silver nitrate solution round the anode is run off into two weighed or tared flasks; about two-thirds of the solution being run into one flask, and the remainder (constituting the middle layer of the solution) into the other. The solutions are then weighed and the amount of silver determined by titration or by electrolytic deposition. If the solution in the second flask does not have the same composition as the original solution, it shows that the experiment has been allowed to continue too long; and it must therefore be repeated, the current this time being stopped after a shorter period.

The method of calculation will be made clear by the following example :—

Composition of silver solution before electrolysis—

9·973 gm. of water
<u>0·0847 „ „ silver nitrate</u>
<u>10·058 „ „ solution</u>

That is, for every 9·973 gm. of water there are 0·0847 gm. of silver nitrate or 0·000498 gm. equivalents of silver. A current of about 6-7 milliamperes was passed through the solution for about $2\frac{1}{2}$ hours.

After electrolysis, the solution had the composition—

¹ The current should be passed until about 0·05 to 0·1 gm. of copper is deposited in the voltameter.

26.76	gm. of water	
0.2818	,, ,,	silver nitrate
27.04	,, ,,	solution.

That is, for every 26.76 gm. of water, there are 0.2818 gm. of silver nitrate, or 0.001658 gm. equivalents of silver.

If the solution had remained unchanged in composition, 26.76 gm. of water would have been associated with $\frac{0.000498 \times 26.76}{9.973} = 0.001337$ gm. equivalents of silver.

There has been an increase, therefore, of $0.001658 - 0.001337 = 0.000321$ gm. equivalents of silver.

The weight of copper deposited in the voltameter amounted to 0.0194 gm. or to 0.000610 gm. equivalents; and the total amount of electricity must be proportional to this number.

If none of the silver had wandered away from the anode, there ought, therefore, to have been an increase of 0.000610 gm. equivalents. But the increase found amounted only to 0.000321 gm. equivalents. Hence there must have wandered away, $0.000610 - 0.000321 = 0.000289$ gm. equivalents of silver; and this number must be proportional to the velocity of the silver ion. Hence the fraction of the total current carried by the cation amounts to $\frac{0.000289}{0.000610} = 0.474$. From this it follows that the fraction carried by the anion amounts to $1 - 0.474 = 0.526$. These two numbers, 0.526 and 0.474, are called the transport numbers of the anion and cation respectively, and are usually represented by n and $1 - n$.

Another form of apparatus which is to be preferred to the simple one shown in Fig. 66, is represented in Fig. 66A.¹ This consists of three tubes, of which A and B correspond with the two limbs of the former apparatus. These two tubes are

¹ Hopfgartner's apparatus is also very suitable. See *Zeitschr. physikal. Chem.*, 1898, 25, 119.

connected by a U-tube, C, by means of rubber tubing furnished with screw clips. At the conclusion of the experiment, these clips are closed and the anode liquid run off through the tap at the bottom of the tube A into a weighed flask. This tube and the electrode are then washed out with a little of the *original solution*, which is also allowed to run into the weighed flask. The clip at D is then opened, and the intermediate solution con-

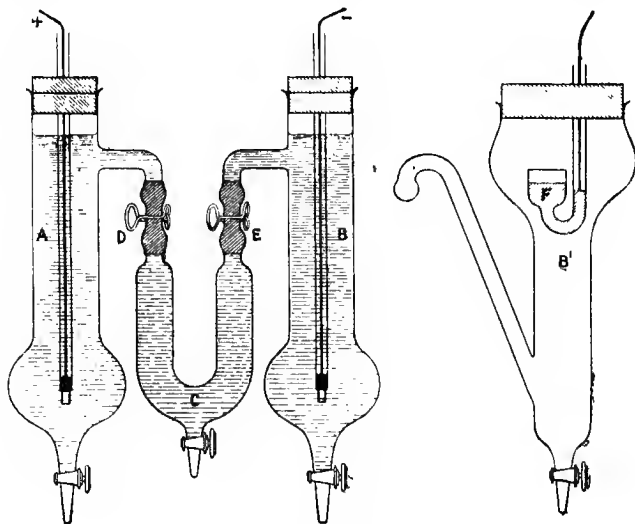

FIG. 66A.

tained in the tube C is run into a separate flask and analysed. The composition of this solution should be unchanged.

It is sometimes convenient also to analyze the cathode solution. This can be run off in exactly the same manner as with the anode solution.

For the determination of the transport number in cases where a gas is evolved at the cathode, the tube B is replaced by B', mercury or platinum being used as cathode.

EXPERIMENT.—*Determine the transport number of the Sodium Ion and Chloride Ion in a solution of Sodium Chloride.*

In the case of salts of metals which decompose water, it is evident that these metals cannot be used as electrodes. In their place one employs as anode a metal which passes into solution when the current is flowing (a soluble anode); and as cathode, mercury, or platinum, is used according to circumstances.

Prepare, by weighing, a solution of pure sodium chloride, containing about 1 per cent. of the salt. Fill the apparatus shown in Fig. 66A with this solution, the tube B being, however, replaced by B'. As anode use a rod of amalgamated zinc fixed into a glass tube with sealing-wax; and as cathode use mercury, contained in a trumpet-shaped tube, F. Pass the electrical current through the solution, as in the previous experiment, using a copper voltameter in circuit. At the conclusion of the experiment close the clips D and E and withdraw the anode and intermediate solutions for analysis, as explained above. The anode solution, after being weighed, may be made up to a definite volume, and its concentration ascertained by a volumetric determination of the chloride. The composition of the intermediate solution should be found unchanged.

In calculating the change in composition of the anode solution, it must be remembered that an amount of zinc equivalent to the copper deposited in the voltameter has passed into solution. The solution, therefore, contains zinc chloride and sodium chloride. To obtain the weight of water contained in a given weight of the solution, the amounts of these salts must be calculated and subtracted from the weight of the solution. The calculation of the transport number is then carried out in a manner analogous to that employed in the case of silver nitrate.

The transport number for Cl' in a solution of sodium chloride of the above concentration, at the mean temperature, is 0.62.

CHAPTER XI

MEASUREMENTS OF ELECTROMOTIVE FORCE

JUST as, in hydrodynamics, the energy of falling water is determined not only by the amount of water that falls, but also by the height of fall, so also in electricity, the electrical energy involves the two factors, *amount of electricity*, and *fall of potential* or *electromotive force*. This latter factor constitutes the driving force, and its measurement is of the utmost importance.

For our present purpose, which is chiefly to study the relations between chemical and electrical energy, measurements of the electromotive force are of especial importance. When a chemical reaction takes place, it is said to be due to the action of chemical affinity, which cannot, however, in general be measured quantitatively, nor, indeed, qualitatively, except in a somewhat indefinite way by means of the heat of reaction. In the case, however, of electrolytic reactions which give rise to electrical energy, as, for example, in galvanic cells, the measure of the affinity is given by the electromotive force of the cell. Therefore, although the amount of electricity delivered by two cells may be the same, the energy need not be so; for just as the chemical affinity in different reactions is different, so also is the electromotive force produced when these reactions take place in a galvanic cell so as to give rise to an electric current. Nor can the heat of reaction be taken as the measure of the electrical energy which a given cell will yield, because only in

a few cases is the latter equal to the heat of reaction; in most cases it is either greater or less. The electromotive force of a cell, therefore, is a measure not of the heat of reaction, but of the diminution of the free energy of a system, which is the thermodynamic expression of what was called above chemical affinity.

For this reason, and also on account of the problems which measurements of the electromotive force enable us to solve, the latter form one of the most important sections of physical chemical practice.

Measurement of the E.M.F. of a Cell—Outline of the Method.—The method usually employed for the determination of the e.m.f. of a cell is essentially that known as the Poggendorff compensation method.

If a source of electricity, A (Fig. 67), of constant e.m.f. is connected with the two ends of a wire, CD, of uniform resistance, then the fall or

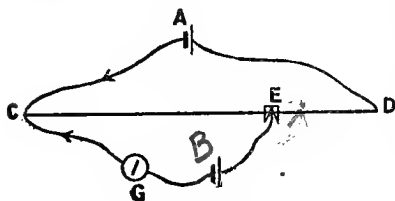

FIG. 67.

potential along the wire will be uniform. The difference of potential between C and any point E of the wire will be proportional to the distance CE, and will be equal to the fraction

$\frac{CE}{CD}$ of the total fall of potential along the wire. If another cell, B, the e.m.f. of which is less than that of A, is inserted along with a suitable indicating instrument, such as an electrometer or galvanometer, in a side circuit, CGBE, so that it is opposed to A, and if the sliding contact E is moved along the wire until no current passes through the measuring instrument; then the e.m.f. of B is equal to that of A multiplied by $\frac{CE}{CD}$.

If the e.m.f. of the cell A, the working cell, were quite

constant and sufficiently accurately known, the measurement of an unknown e.m.f. could be made in the manner described. As a rule, however, neither of the above conditions is fulfilled. It is therefore necessary to have a standard cell, the e.m.f. of which is accurately known. The point of balance E on the bridge wire is then determined when the standard cell occupies the place of B; and then the point E' (say) when the cell of unknown e.m.f. is in place of B. The unknown e.m.f. is then obtained from the relationship—

$$\frac{CE}{CE'} = \frac{\text{e.m.f. of standard cell}}{\text{unknown e.m.f.}}$$

Apparatus.—*The Working Cell.*—As working cell A, one must employ a cell with a greater e.m.f. than is to be measured. Since in all cases to be studied here, the e.m.f. is less than 2 volts, the most convenient working cell to use is a lead accumulator, which, when fully charged, has an e.m.f. of somewhat over 2 volts. In order that the cell shall not run down too rapidly, and the e.m.f. therefore, fall, an accumulator of fairly large capacity should be employed. Where large fixed cells are not available, a portable accumulator of 30 to 40 ampere-hours capacity is very suitable.

Instead of a lead accumulator, one may also conveniently employ two or three cupron cells connected in series; the e.m.f. of a cupron cell being about 0.85 volt.

Measuring Wire.—The measuring wire described on p. 173 may be employed, and should be calibrated as described on p. 174 before being used. Although for most purposes the shortened bridge (60 cm. of scale) is sufficient, there are occasions when the longer scale is, if not necessary, at least rather more convenient.

If we take the fall of potential along the bridge wire as being 2 volts, then 1 mm. of wire corresponds with 2 millivolts. So far as the bridge wire is concerned, therefore, an accuracy

of 0.2 to 0.4 millivolts (corresponding with 0.1 and 0.2 mm. on the scale) is attainable. Whether or not it is attained in practice will depend largely on the sensitiveness of the galvanometer or other measuring instrument employed. For all our purposes, an accuracy of 1 millivolt will be sufficient.

Standard Cell.—Various cells have from time to time been recommended as standards of e.m.f., but the most convenient and the one now most generally employed is the cadmium cell (Weston cell). This possesses the advantages not only of being easily reproduced, but also of having a small temperature coefficient of e.m.f.¹

For ordinary laboratory purposes, the form of cell shown in Fig. 68 is very convenient, and

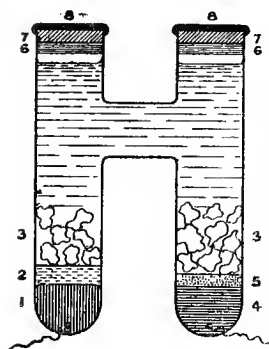

FIG. 68.

1. Mercury.
2. Paste of cadmium sulphate and mercurous sulphate.
3. Saturated solution and large crystals of cadmium sulphate.
4. Cadmium amalgam.
5. Small crystals of cadmium sulphate.
6. Paraffin.
7. Cork.
8. Sealing-wax.

can be put together by the student himself. The cell itself consists of a H-shaped glass vessel with platinum wires sealed in near the closed ends of the side tubes. The vessel is supported on a wooden base by means of a metal clamp, or, more simply, by means of a large cork cut to the appropriate shape. The platinum wires are connected, without strain, to two terminals.

Prepare a saturated solution of pure, crystallized cadmium sulphate ($\text{CdSO}_4 \cdot \frac{8}{3} \text{H}_2\text{O}$), either by shaking excess of the finely powdered salt with distilled water, or by grinding crystals of cadmium sulphate in a mortar under water. In making

¹ Another cell, sometimes used as a standard of electromotive force, is the Clark cell.

this saturated solution, the temperature should not be raised above 75° , because at this temperature the salt $\text{CdSO}_4 \cdot \frac{8}{3}\text{H}_2\text{O}$ changes to the monohydrate, $\text{CdSO}_4 \cdot \text{H}_2\text{O}$.

Into the one limb of the **H**-shaped vessel there is poured a quantity of cadmium amalgam containing about 12.5 per cent. of cadmium. This is prepared by adding 1 part by weight of pure cadmium, free especially from zinc, to 7.0 parts of pure mercury (*vide infra*) and warming on a water bath. The amalgam which is liquid at temperatures of about 100° , should be well stirred with a glass rod and then poured into the limb of the **H**-vessel, which is kept warm by immersion in hot water. When sufficient amalgam has been poured in to cover the platinum wire to a depth of about half a centimetre, the vessel is removed from the hot water and allowed to cool. On cooling, the amalgam solidifies.

On the top of the amalgam there is placed a thin layer, about 2 mm. deep, of moist, finely powdered cadmium sulphate crystals (left undissolved in the preparation of the saturated solution).

Into the other limb of the **H**-vessel, a quantity of pure mercury is poured so as to cover the platinum wire and form a layer about 1 cm. deep, and on the top of this is spread a layer, 3 mm. deep, of mercurous sulphate paste. The latter is made by rubbing together in a mortar, mercurous sulphate and mercury together with a small quantity of cadmium sulphate crystals and sufficient of the saturated solution of cadmium sulphate to form a thin cream. The liquid is then filtered off through a plug of cotton-wool placed in the stem of a funnel, with the aid of a filter pump. The paste is again rubbed up with a further quantity of the cadmium sulphate solution, and again filtered. The process should be repeated a third time. The purpose of this is to remove any mercuric sulphate which may be present.

Having placed this paste, moistened with a little solution

of cadmium sulphate, on the top of the mercury, several fairly large and clear crystals of cadmium sulphate are placed in either limb of the vessel, which is then filled up to within about 1.5 cm. of the open ends with saturated cadmium sulphate solution. The open ends of the tubes are then closed by means of a layer of paraffin wax and a disc of cork, and the latter is then entirely covered with sealing-wax.

In closing up the ends of the vessel, the precaution should be observed of having a small air-space in one or both limbs of the vessel, so as to allow for the expansion of the liquid in hot weather. If any difficulty is experienced in enclosing an air-bubble, it can easily be got over in the following manner: A thin layer of melted paraffin is first poured into one limb only of the vessel; and when this has solidified, a small pin-hole is made through it and the vessel inclined slightly so as to draw air in through the pin-hole. The latter is then closed by means of more paraffin while the vessel is still inclined.

The finished cell has the appearance shown in Fig. 68.

The e.m.f. of the cadmium cell prepared in the above manner has the following values:—

Temperature.	e.m.f. in volts.
5°	1.0189
10°	1.0189
15°	1.0188
20°	1.0186
25°	1.0184

At the ordinary temperature (15°–18°) we may, for our purpose, take the e.m.f. as equal to 1.019 volts. In this cell the mercury forms the positive, the amalgam the negative pole.

Purification of Mercury.—For the above purpose, and also for many other purposes in physical chemistry, pure mercury,

free especially from less noble metals such as zinc and lead, is required. For the purification, either of the following methods can be employed; preferably the latter when the amount of mercury to be purified is comparatively small.



FIG. 69.

1. The mercury is placed in a moderately wide tube, bent as shown in Fig. 69, and a current of air is drawn for several hours through the metal with the help of a filter pump. The zinc and lead are thereby oxidized, and rise to the surface as a scum. The pure mercury is then at once poured out through the lower end of the tube.

2. If the amount of mercury is smaller, it is best shaken for ten or twenty minutes (according to the degree of impurity) with a solution of mercurous nitrate acidified with nitric acid. It is then well washed with distilled water, and dried by means of filter paper. Still better, the purified mercury is poured in a fine stream, by means of a funnel with drawn-out point, through a layer of mercurous nitrate solution acidified with nitric acid, contained in a tube to the lower end of which a bent capillary tube (1 mm. bore) is sealed (Fig. 70). The length of the latter should be so fixed that mercury ceases to flow from it, when there is still a layer of mercury in the wide tube of about 2 cm. in depth. By means of this apparatus, the mercury is obtained dry.



FIG. 70.

In filling this tube for the first time, pure mercury must first be poured into the tube, and then the solution of mercurous nitrate; and in no case should impure mercury be poured through the tube.

Capillary Electrometer.—For the purpose of determining the point of balance on the bridge wire (p. 214), one may employ either a sensitive galvanometer, or an electrometer. For our purpose, the most convenient instrument is the capillary electrometer, of the form shown in Fig. 71.¹

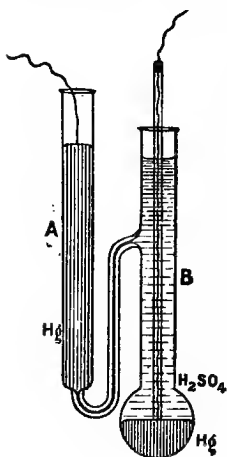

FIG. 71.

Pure dry mercury is poured into the limb A of the electrometer so as to cause the meniscus to stand about two-thirds up the capillary portion. Mercury is also poured into the other limb, B, so as to about half fill the bulb, and the rest of this tube is then filled by means of a fine pipette with dilute sulphuric acid (1 part of acid to 6 parts of water by volume), which has previously been shaken with a little pure mercury. In order to get the sulphuric acid into the capillary, a piece of india-

rubber tubing is attached to the end of the limb A, and mercury blown out through the end of the capillary into B. On now sucking back, the mercury is brought again within the capillary, and the acid follows it. Care must, however, be taken not to suck so strongly that the acid is drawn round the bend of the capillary into A. When in use, also, the walls of the capillary must be kept well wetted with acid, and this is effected in the same way by blowing or sucking through a tube attached to the limb A, so as to move the mercury up and down the capillary.

Contact with the mercury in either limb is effected by means of thin platinum wires fused or soldered to thin, well-insulated

¹ This instrument has recently been considerably improved. It is filled with carefully boiled sulphuric acid and pure mercury, and then hermetically sealed. The platinum wires are fused into the glass.

copper wires. (The platinum and copper wires can be easily fused together in the blow-pipe flame.) In the case of the wire making contact with the mercury in the limb A, the junction of the two wires must be carefully covered by means of sealing-wax or varnish, in order to prevent the copper coming in contact with the mercury. In the case of the other wire, either a sufficiently long piece of platinum must be used to pass down through the acid into the mercury, or a short piece of platinum wire may be fused to a thin copper wire, and the latter protected from the acid by sealing the wire into a narrow, thin glass tube, made by drawing out a test-tube. The upper end of this tube may be closed and strengthened by means of sealing-wax.

The position of the mercury meniscus in the capillary depends on the surface tension between the mercury and the sulphuric acid; and this, in turn, depends on the electrical potential between the mercury and the acid. If this potential is altered, as, for example, by connecting the two mercury electrodes with a cell or with two points of a circuit between which there is a difference of potential, the meniscus will move; and for small differences of potential, the amount of movement is proportional to the difference of potential. In order, however, that the meniscus shall take up a definite position, the two electrodes must be connected together except when making a measurement. This is effected by means of a triple contact Morse key, shown in Fig. 72. The electrical connections between the terminals *a*, *b*, *c* and the contacts *a'*, *b'*, *c'* are indicated by means of the dotted lines.* The electrodes of the electrometer are connected with the terminals *b* and *c*, so that they are connected together when the key is in its normal position. The terminals *a* and *c* are connected with the rest of the circuit, so

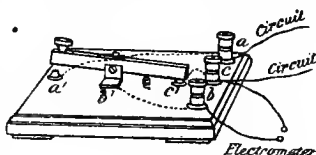

FIG. 72.

that on depressing the key, the current can pass from a to a' , thence through the bar of the key to b , and through the electrometer to c .

In using the capillary electrometer, care should always be taken that the direction of the positive current through the electrometer is from the large electrode to the capillary. This is ensured by making the connections as shown in Fig. 73. The

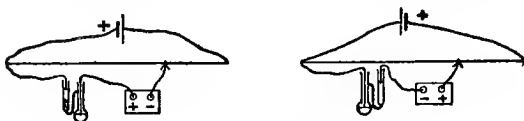

FIG. 73.

reason for this is to prevent the formation of mercurous sulphate in the capillary, which might occur if the capillary mercury were anode, and a rather large current were sent through the electrometer at any time, such as when looking for the point of balance.

In order that the capillary electrometer shall work well, it is necessary that the glass and mercury shall be quite clean. Usually, the tubes as supplied by the makers will be found to give satisfactory results, without any treatment. If the tube should become dirty through use (or misuse), it is frequently better to discard it altogether, although it can, as a rule, be cleaned by treatment with hot nitric acid followed by a hot solution of potassium bichromate and sulphuric acid; or a hot solution of caustic soda, and again followed by hot nitric acid. It must then be well washed with distilled water, and dried by drawing air, filtered through a plug of cotton-wool, through the tube.

As the movements of the mercury meniscus near the point of balance are very small, they must be observed by means of a microscope. A convenient form of electrometer stand is

shown in Fig. 74. The capillary electrometer is fixed opposite the end of a microscope by means of a small clamp, and the surface of the meniscus is illuminated by means of a mirror or by a small electric lamp, the light of which should be diffused by means of white tissue paper or ground glass. The sharpness of the image of the meniscus in the microscope is increased by cementing a thin strip of glass (microscope cover glass) with Canada balsam on the front of the capillary. In the eye-piece of the microscope there is a scale, which allows of the movement of the mercury in the electrometer being measured.

EXPERIMENT.—*Standardization of the Cadmium Cell.*

After the cadmium cell has been prepared as described on p. 216, it should, before being used for measurements, be compared with an accurately known e.m.f., say, with another cadmium cell which has already been standardized.

Fit up the apparatus as shown in the diagram, Fig. 75. A is the working cell (p. 215) which is connected through the key K_1 (e.g. an electric switch key) to the ends of the bridge wire ab . E is the capillary electrometer, the electrodes of which are connected with the terminals T_1 and T_2 , by means of thin, insulated copper wire. M is a Morse tapping key (p. 221), and K_2 is a two-way key by means of which either cell W_1 or

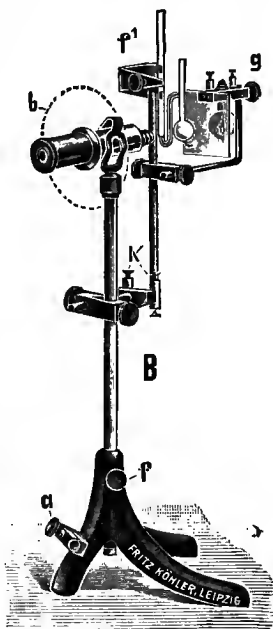

FIG. 74.

cell W_2 can be put in circuit. C is the sliding contact on the bridge wire. The different connections are best made with flexible well-insulated wire.

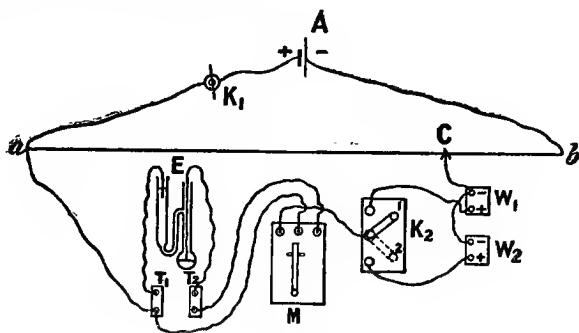

FIG. 75.

If a two-way key K_2 is not available, its place can be taken by the arrangement shown in Fig. 76, A. This consists of a block of wood or of paraffin (obtained by melting paraffin and pouring it into a cardboard mould, *e.g.* the lid of a photographic

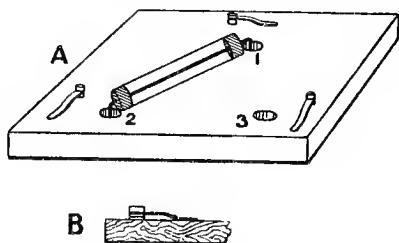

FIG. 76.

plate box) furnished with three mercury cups, into which the amalgamated ends of the wires from the tapping key and from the cells are placed. Between the cups 1 and 2 and 1 and 3

a shallow groove is cut in which the connecting wire of thick copper, fixed into a glass tube, rests.

In order to prevent the ends of the wires lifting out of the mercury cups, they should be passed underneath small clips of wire or foil fastened beside the cups (Fig. 76, B).

A three-way key (Fig. 77) can be made in a similar manner.

The apparatus having been connected together, the current is allowed to flow from the working cell through the bridge wire. By means of the two-way key, place the standardized cell (W_1) in the circuit, and move the sliding contact C to, say, mark 60 on the measuring bridge. Depress the tapping key *sharply* but not violently, and notice if there is any movement of the mercury in the electrometer. Suppose the mercury moves up (apparently down in the microscope). Move the sliding contact down the wire until a point is reached at which, on depressing the tapping key, the mercury in the electrometer moves in the opposite direction. The point of balance must then lie between these two positions. Now move the sliding contact up the bridge again, say 1 cm. at a time, and note the point at which there is again a reversal of the direction of movement of the mercury. The sliding contact should now be moved 1 mm. at a time, and in this way two points can be found, not more than 1 mm. apart, between which the point of balance must lie. We may now move the sliding contact carefully within this distance of 1 mm. and find the point at which there is no movement in the electrometer; or, with the sliding contact at two points about 1 mm. apart and on either side of the point of balance, we may note the number of divisions on the scale of the microscope over which the mercury meniscus passes, and calculate from these, by proportion, the position of the point of balance.

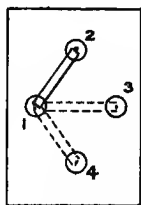

FIG. 77.

On nearing the point of balance, it will generally be found difficult to detect the movement of the mercury meniscus on depressing the tapping key. In this case, keep the key depressed for say 5 seconds, and then release quickly, and note if there is any movement of the meniscus. Several readings should be made in this way with the sliding contact in the neighbourhood of (not more than half a millimetre away from) the point of balance. Having obtained a reading for the standard cell W_1 , alter the two-way key so as to put the cell W_2 in circuit, and find, in the manner described above, the point of balance for W_2 . Then determine the point of balance for W_1 again in order to make sure that the fall of potential along the wire has not altered.

If R_1 and R_2 are the readings for the standardized cell W_1 , and for the cell to be standardized, W_2 , respectively, we have—

$$\frac{\text{e.m.f. of } W_2}{\text{e.m.f. of } W_1} = \frac{R_2}{R_1}$$

$$\text{or, e.m.f. of } W_2 = \frac{R_2}{R_1} \times \text{e.m.f. of } W_1$$

Seat of Electromotive Force of a Cell.—When we have a galvanic cell inserted in a circuit, it is, in general, possible for sudden changes of potential to occur at different points of the circuit. Thus, suppose we have the cell—

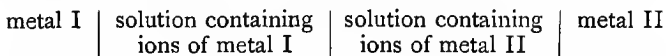

and suppose the two poles to be connected through a length of resistance wire, say of nickelin. Then, sudden differences of potential are possible (1) at the junctions of the nickelin with the poles; (2) at the junction between the metal I and the solution; (3) at the junction between metal II and the solution; (4) at the junction between the two solutions. Under ordinary conditions, when the temperature is constant, the potential

differences under (1) vanish. Not so, however, the potential differences between the two solutions (contact potential). Here an appreciable potential difference may exist, due, as the theory shows, to the difference in the velocities of migration of the ions. In some cases this potential difference can be calculated, but not in all cases; and it is better, where possible, to reduce this contact potential so as to make it negligible. Two chief ways of doing this are, first, to have present in the two solutions a relatively large (and equal) concentration of an indifferent electrolyte (potassium nitrate being frequently useful for this purpose); and, second, to insert between the two solutions a concentrated solution of potassium chloride (three or four times normal). In this way, the chief and, practically, the only differences of potential occur at the junctions of the metals with the solutions; and, therefore, the e.m.f. of the cell will be equal to the algebraic sum of these potentials.

The difference of potential between a metal electrode and a solution of one of its salts may be regarded as due to the passage into solution and ionization of the metal (in which case the electrode becomes negative to the solution), or to the discharge of the metal ions in the solution at the electrode (in which case the electrode becomes positive to the solution).

The potential which is observed will therefore depend on the metal which forms the electrode, and also on the concentration of its ions in the solution surrounding it (see below). When the metal is positive with respect to the solution, it is said to have a positive (+) potential; when it is negative to the solution, it is said to have a negative (-) potential. This convention is, however, not universally employed.

Measurement of Single Electrode Potentials.—In order to measure the potential between an electrode and a solution, it is necessary to have another electrode and solution, the potential difference between which is known. As standard electrode we shall employ what is generally known as the

calomel electrode. This consists of mercury in contact with a solution (normal or deci-normal) of potassium chloride saturated with mercurous chloride.

Preparation of the Calomel Electrode.—As a vessel to contain the mercury and the solution, one may use a small, wide-mouthed bottle or a short glass cylinder with foot; but one of the most convenient forms of vessel is shown in Fig. 78. It

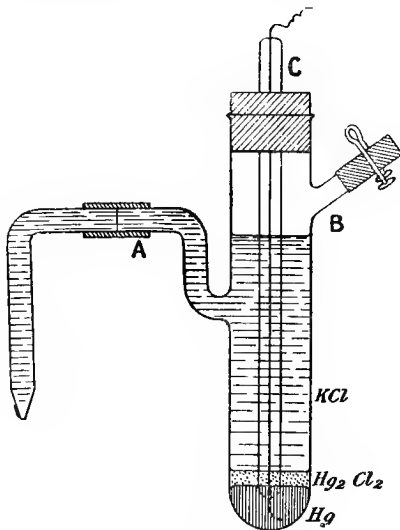

FIG. 78.

consists of a glass tube furnished with a bent side tube A, and a short straight side tube B, near the top. It is most convenient to have the tube A in two portions connected by rubber tubing, so that the free end can be detached and washed out when necessary. Over the end of the side tube B there should be passed a piece of india-rubber tubing which can be closed by a spring or screw-clip. Connection with the mercury electrode

is effected by means of a platinum wire, either sealed into the bottom of the electrode vessel, or sealed into a glass tube and passed through a rubber stopper in the mouth of the tube. In the latter case, electrical connection is made by means of mercury in the tube C, into which an amalgamated copper wire dips; or the copper wire may be fused to the platinum wire before the latter is sealed into the tube.

First prepare the normal solution of potassium chloride, using pure recrystallized potassium chloride (dried) for the purpose. In the bottom of the electrode vessel, previously thoroughly dried or washed out with the solution of potassium chloride, place a small quantity (1-2 c.c.) of pure mercury (p. 218), and over this a layer of calomel paste. This paste is prepared by rubbing together in a mortar calomel and mercury with some of the solution of potassium chloride. It is then washed two or three times with a quantity of the potassium chloride solution, the mixture being allowed each time to stand until the calomel has settled, and the solution then decanted off. Finally, the paste is shaken up with the remaining quantity of the potassium chloride solution (in order to saturate the latter with calomel), which should then be decanted off and kept in a stoppered bottle for future use.

Having placed the mercury and the calomel paste in the tube, insert a rubber stopper or paraffined cork, carrying the glass tube C, with platinum wire, which must dip into the mercury at the bottom of the tube. The vessel is then filled with the solution of potassium chloride saturated with calomel and mercury, by sucking in the solution through the bent side tube A, and then closing the rubber tube on B with a clip. The potential difference between the mercury and the solution is + 0.560 volt at 18°, the mercury being positive to the solution. The potential difference increases by 0.0006 volt per degree.

The vessel may be supported for use, either in the clamp of

a retort stand, or, very simply and conveniently, in a split brass collar on a block of wood or metal (Fig. 79). For making connection between the mercury electrode and the rest of the circuit, it is very convenient to have a double terminal, T, screwed into the base.

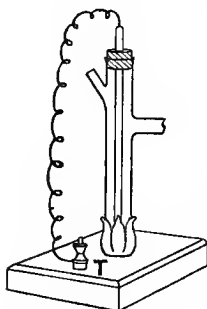
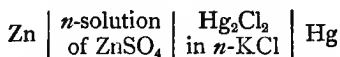

FIG. 79.

Electrode Potentials. — When a metal is placed in a liquid, there is, in general, a potential difference established between the metal and the solution owing to the metal yielding ions to the solution, or the solution yielding ions to the metal. In the former case, the metal will become negatively charged to the solution; in the latter case, positively charged.

Since the total e.m.f. of a cell is (or can in many cases be made practically) equal to the algebraic sum of the potential differences at the two electrodes, it follows that if we know the e.m.f. of a given cell, and the value of the potential difference at one of the electrodes, we can calculate the potential difference at the other electrode. For this purpose, use is made of the standard calomel electrode, which is combined with the electrode and solution between which one wishes to determine the potential difference.

In the case of any particular combination, such as the following—



the positive pole of the cell can always be ascertained by the way in which the cell must be inserted in the side circuit (Fig. 73, p. 222), in order to obtain a point of balance on the bridge wire. In order to obtain a point of balance, the cell must be opposed to the working cell; and therefore, if the positive pole

of the latter is connected with the end *a* of the bridge wire, it follows that the positive pole of the cell in the side circuit must also be connected with *a*.

On measuring the e.m.f. of the above cell, we shall find it to be about 1·07 volts, and from the way in which the cell has to be connected to the bridge wire, we find that the mercury is the positive pole; hence, the current must flow *in the cell* from zinc to mercury. We therefore draw an arrow under the diagram of the cell showing the direction of the current, and place beside it the value of the e.m.f., thus—

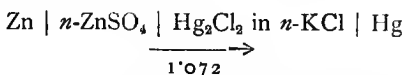

We further know that the mercury is positive to the solution of calomel, so that the potential here tends to produce a current from the solution to the mercury. This is represented by another arrow, alongside of which is placed the potential difference between the electrode and the solution, thus—

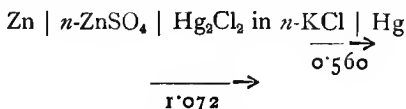

Since the total e.m.f. of the cell is 1·072 volts, and since the potential difference between the calomel and the mercury is 0·560 volt, it follows that the potential difference between the zinc and the solution of zinc sulphate must be 0·512 volt, and this also must assist the potential difference at the mercury electrode. Thus we have—

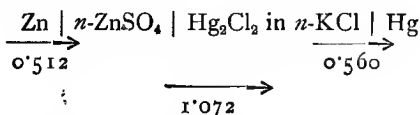

From the diagram we see that there is a tendency for

positive electricity to pass from the zinc to the solution, *i.e.* the zinc gives positive ions to the solution, and must, therefore, become itself negatively charged relatively to the solution. We therefore say that the potential difference between zinc and the normal solution of zinc sulphate is -0.512 volt. By adopting the above method, errors both in the sign and in the value of the potential difference can be readily avoided.

Preparation of Electrodes.—The copper and zinc electrodes to be used in the following experiment are prepared as follows: Pieces of pure zinc and copper rod, about 3 cm. in length, are soldered to fairly thin, insulated copper wire, and then cemented into glass tubes by means of sealing-wax, care being taken that the soldered junction is completely protected by the wax. Before use, the zinc electrodes are amalgamated by placing them in dilute sulphuric acid and rubbing mercury over them with a mop of cotton-wool; after which they are well washed with distilled water. The copper electrodes, on the other hand, should first be cleaned by rubbing them with emery-paper or by dipping them in dilute nitric acid, and then, after being washed, coated electrolytically with copper. For this purpose, the solution of copper sulphate used in the voltameter, p. 209, may be employed, a strip of copper being used as anode. In order to obtain a fine, adherent deposit, a small current density (not exceeding 0.5 amp. per 100 sq. cm. at the cathode) should be used. At least two electrodes should be prepared in the above manner from each metal; and before use, the uniformity of each set of electrodes must be tested by determining whether they give any e.m.f. when immersed in the same solution of copper sulphate (in the case of the copper electrodes) or of zinc sulphate (in the case of the zinc electrodes).

Testing the Uniformity of the Electrodes.—Fix the electrodes into tubes like the one used for the standard electrode (p. 230, cf. Fig. 78), and fill the tubes with a solution of copper

sulphate (in the case of the copper electrodes) and with a solution of zinc sulphate (in the case of the zinc electrodes). Decinormal solutions of the salts may be used for this purpose. Liquid connection between the electrodes is made by means of an intermediate solution of copper sulphate or of zinc sulphate (Fig. 80).

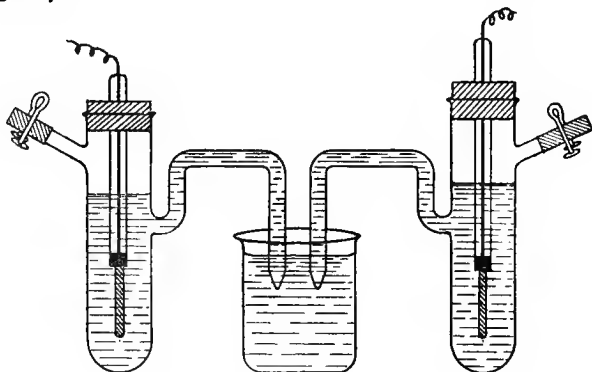

FIG. 80.

Fit up the apparatus as shown in Fig. 75, p. 224, replacing the cell W_2 by the cell $\text{Cu} \mid \text{solution of } \text{CuSO}_4 \mid \text{Cu}$ or the cell $\text{Zn} \mid \text{solution of } \text{ZnSO}_4 \mid \text{Zn}$ connected in series with the standard cell W_1 . By means of the two-way key, the point of balance on the bridge wire is determined, with the cell W_1 alone in the circuit, and then for the cell W_1 together with one of the above cells. If the two copper (or zinc) electrodes are uniform, the point of balance should be the same in the two cases, *i.e.* the cells $\text{Cu} \mid \text{solution of } \text{CuSO}_4 \mid \text{Cu}$ and $\text{Zn} \mid \text{solution of } \text{ZnSO}_4 \mid \text{Zn}$ should exhibit no e.m.f. If, however, an e.m.f. of more than 1 millivolt should be found (for method of calculation, see p. 226), then the two copper (or zinc) electrodes should be placed in a solution of copper sulphate (or zinc sulphate) and short-circuited for several hours or a

day, until they no longer give an e.m.f. when placed in the same solution. Only when this is the case should the electrodes be used for the following experiment:—

EXPERIMENT.—*Determine the Potential Difference between Zinc and a Solution of Zinc Sulphate, and between Copper and a Solution of Copper Sulphate.*

Having prepared uniform zinc and copper electrodes as described above, fix them into the electrode vessels as before, and fill the latter with deci-normal solutions of zinc sulphate and copper sulphate respectively. In order to determine the potential difference between the metal and the solution, each electrode is combined separately with a standard calomel electrode (p. 228) by means of an intermediate solution of potassium chloride (3-norm.) to form a galvanic cell in the manner shown in the diagram, Fig. 80, p. 233.

The apparatus is fitted up as shown in Fig. 75, p. 224, the Weston cell W_2 being replaced by the cell

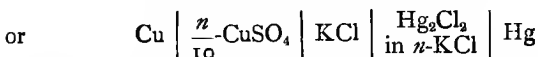

As it will, in general, be unknown which is the positive and which the negative electrode of the above combinations, it will be more convenient to replace the two-way key (K_2 in Fig. 75) by a set of four mercury cups (K'_2 in Fig. 81; cf. Fig. 77, p. 225) so that the connections can be readily altered. Thus we obtain the following arrangement (Fig. 81): Assuming that the positive pole of the working cell is connected with the end a of bridge wire, then the wire from the Morse tapping key M will remain permanently in the mercury cup 4, the positive (mercury) pole of the Weston cell will be permanently connected with cup 2, and the negative pole with cup 1. With this cup also the sliding contact C will be connected.

By means of a piece of thick copper wire with bent ends (amalgamated) make connection between the cups 4 and 2,

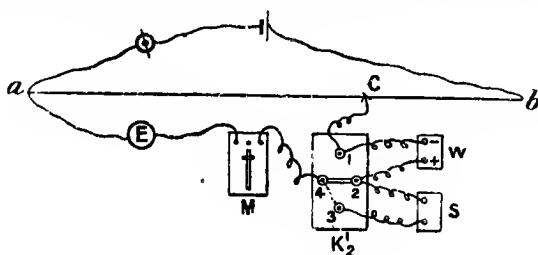

FIG. 81.

thus putting the Weston cell in the circuit. Determine the point of balance on the bridge wire. Then connect the electrodes of the combination cell (S) with the cups 1 and 3, and place the connecting bridge between the cups 4 and 3, thus putting the cell S in circuit. If no point of balance can be obtained, *i.e.* if the mercury in the electrometer moves in one direction only, no matter where the sliding contact is placed, this shows that the wrong pole (the + pole) of the cell S has been connected with the sliding contact. Interchange, therefore, the two wires from S, putting that which was previously in the cup 1 into the cup 3. It should now be possible to obtain a point of balance on the bridge wire. This also indicates which is the positive and which the negative pole of the cell S. If the e.m.f. of S is small, the point of balance will be near the end *a* of the bridge wire, and in this case the error in reading will be comparatively great. In this case, therefore, it is better to connect the cell S in series with the Weston, which is done by connecting the negative pole of the cell S with the cup 2, while the positive pole is of course connected with the cup 3. The reading now obtained on the bridge wire corresponds with the sum of the e.m.f.'s of the Weston and the cell S.

Take several readings, alternately, of the point of balance for the Weston alone and for the Weston plus the cell S. The e.m.f. of S is then obtained from the equation (cf. p. 226)—

$$\frac{\text{e.m.f. of } W + S}{\text{e.m.f. of } W} = \frac{R_2}{R_1}$$

where R_2 and R_1 are the readings for the Weston plus S, and for the Weston alone, respectively. Putting the value of the e.m.f. of the Weston equal to 1.019 volts, we obtain—

$$\text{e.m.f. of } S = \left(\frac{R_2}{R_1} \times 1.019 \right) - 1.019 \text{ volts}$$

From this, knowing the potential of the calomel electrode (p. 229), the potential between the copper and copper sulphate or zinc and zinc sulphate can be calculated (see p. 231).

Further Measurements.—Having determined in the above manner, the electrode potentials—

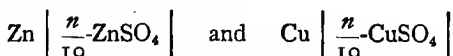

determine, in the same way, the electrode potentials—

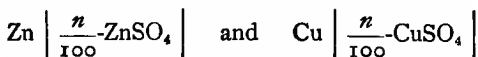

Further, determine the e.m.f. of two or more of the combinations—



and compare the values of the e.m.f. found with the sum of the electrode potentials as determined above.

Influence of Concentration.—It has already been remarked that the potential difference between a metal and a solution of one of its salts depends on the concentration of the metal ions in the solution ; and this difference will have already become evident from the experiments just described.

If we are dealing with completely ionized binary electrolytes, then, according to the theory, the change in the electrode potential with concentration is given by the expression—

$$e = e_0 + 2.3026 \frac{RT}{nF} \log_{10} \frac{C}{C_0}$$

where e is the potential difference for the ionic concentration C ; e_0 that for the concentration C_0 ; R is the gas constant ($= 8.32 \times 10^7$ absolute units) ; T the absolute temperature at which the measurement is made ; n the valency of the ion furnished by the electrode ; F signifies 1 faraday (96,580 coulombs). e must be taken with its proper sign ; and we see, therefore, that if the electrode potential is positive, it will be diminished by dilution, while if it is negative, it will increase with dilution, *i.e.* will become more negative.

The numerical values of $2.3026 \frac{RT}{F}$ at 0° , 18° , and 25° Centigrade are as follows :—

T	$2.3026 \frac{RT}{F}$
273°	0.0542
$273 + 18^\circ$	0.0577
$273 + 25^\circ$	0.0591

At the ordinary temperatures (15° – 20°) we can take the value as being 0.058 volts. Hence it follows that if the metal-

ion is monovalent, a ten-fold increase or diminution in the concentration of the metal ions will produce a change in the potential difference between the metal and the solution of 0.058 volts. If the metal ion is n -valent, the corresponding change in the potential difference will be $\frac{0.058}{n}$ volts.

The electrode potential of zinc in deci-normal and centi-normal solutions of zinc sulphate, and of copper in corresponding solutions of copper sulphate, has already been measured. The values obtained should be compared with those required by the above theory. Since the ionic concentrations are not the same as the total concentrations, we should put $C = \alpha c$, and $C_0 = \alpha_0 c_0$, where α and α_0 are the degree of ionization at the concentrations (total concentrations of salt) c and c_0 .

The values of α for the different zinc and copper sulphate solutions may be taken as follows:—

$$\frac{n}{10}\text{-ZnSO}_4 : \alpha = 0.39$$

$$\frac{n}{100}\text{-ZnSO}_4 : \alpha = 0.63$$

$$\frac{n}{10}\text{-CuSO}_4 : \alpha = 0.37$$

$$\frac{n}{100}\text{-CuSO}_4 : \alpha = 0.60$$

EXPERIMENT.—*Determine the Influence of Concentration on the Potential Difference between Silver and Solutions of Silver Nitrate.*

Prepare two silver electrodes from stout silver wire, cementing them into tubes as in the case of zinc and copper electrodes (p. 232). The electrodes should be coated with a fresh deposit of silver, and the uniformity of the electrodes must be tested

in the manner given for the zinc and copper electrodes (p. 232).
The e.m.f. of the cells—

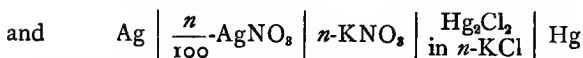
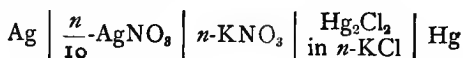

should then be measured as described above. The degree of ionization at 18° of silver nitrate may be taken as 0.81 in the case of the deci-normal solution, and 0.93 in the case of the centi-normal solution.

An error of 2 millivolts may be allowed. Consider, therefore, the accuracy with which the solutions must be prepared.

Concentration Cells.— Since the potential difference between a metal and its solution depends on the concentration of the latter, and since the e.m.f. of a cell depends on the differences of potential at its poles (electrodes), it follows that if we have two electrodes of the same metal dipping in solutions of a salt of the metal of different concentrations, such a combination will possess an e.m.f. and can give rise to a current. A cell of this description, the e.m.f. of which is due to a difference in the concentration of the same electrolyte around the two electrodes, is known as a *concentration cell*.¹

In such cases the e.m.f. is not merely equal to the sum of the electrode potentials as measured against a calomel electrode, but is given by the expression—

$$e = \frac{v}{u + v} \cdot \frac{2 \times 0.058}{u} \log_{10} \frac{C_1}{C_2}$$

when we are dealing with a completely ionized binary electrolyte. In the above equation, $\frac{v}{u + v}$ represents the transport number of the anion, and u the valency of the metal ion; while

¹ Strictly, a "concentration cell with migration."

C_1 and C_2 are the *ionic* concentrations of the metal ions in the two solutions.

EXPERIMENT.—*Determine the Concentration of Silver Ions in a given Solution.*

In order to determine the concentration of silver ions in a given solution, it is only necessary to measure the e.m.f. of a cell of the type—

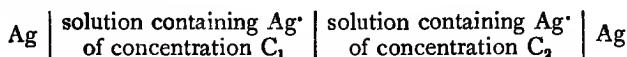

For the purpose of our experiment we may take a $\frac{n}{100}$ -solution of silver nitrate as the solution in which the concentration of silver ions is to be determined. Prepare, therefore, the following cell—



after the pattern of the cell shown in Fig. 80, p. 233. The silver electrodes should be prepared as described on p. 232, their uniformity being ascertained before they are employed for the measurements. The e.m.f. is then determined as in the experiment, p. 238. Putting the transport number of the anion equal to 0.53, the concentration of the silver ions in the $\frac{n}{100}$ -solution is given by the equation—

$$e = 0.53 \times 2 \times 0.058 \log_{10} \frac{0.1a}{x}$$

where a is the degree of ionization of silver nitrate in $\frac{n}{10}$ -solution (0.81). Since the degree of ionization of silver nitrate in $\frac{n}{100}$ -solution is 0.93 at 18°, the value of x should be 0.0093. In this experiment an error of 5–10 per cent. in the value of x

is allowable. This large error is permissible here partly on account of the errors in the determination of the e.m.f., and partly on account of the deviations of the solutions of the above concentration from the simple gas laws and dilution laws.

Solubility Measurements.—An important application of the measurements of the e.m.f. of concentration cells consists in the determination of the solubility of sparingly soluble salts. To illustrate this, the following experiment should be made:—

EXPERIMENT.—*Determine the Solubility of Silver Chloride in Water.*

For this purpose the following cell is fitted up—

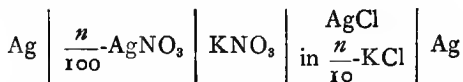

The silver electrodes are prepared as in the previous experiment. To the solution of $\frac{n}{10}$ -KCl, surrounding one electrode, one or two drops of a silver nitrate solution are added, in order to give a precipitate of silver chloride. A saturated solution of silver chloride in $\frac{n}{10}$ -KCl is thus obtained. Determine the e.m.f. of the cell in the manner described above. Representing the e.m.f. by e , we have—

$$e = 0.53 \times 2 \times 0.058 \log_{10} \frac{0.01}{x}$$

where x is the concentration of the silver ions in the $\frac{n}{10}$ -solution of potassium chloride. Further, the concentration of the chloride ions is known, since it is equal to the concentration of Cl' in $\frac{n}{10}$ -KCl solution. That is, it is approximately equal to 1×10^{-4} .

For a saturated solution we have—

conc. of Ag^+ \times conc. of Cl^- = solubility product = K

The value of K is then found by multiplying the concentration of Ag^+ as given by the value of the e.m.f. of the above cell by 1×10^{-1} (or, more correctly, by this number multiplied by the degree of ionization of potassium chloride in deci-normal solution). Since in pure aqueous solution the concentration of the silver ions is equal to the concentration of the chloride ions, it follows that the concentration of either is equal to \sqrt{K} . Further, if we assume, as we may, that the silver chloride at this dilution is completely ionized, then \sqrt{K} also gives the concentration of silver chloride in the solution, *i.e.* the solubility.

In this way, the solubility of silver chloride in aqueous solution was found to be 1.2×10^{-6} gm. equivalents per litre at 25° .

As in the above experiment, the measurements were carried out at room temperature, and as the calculation has been carried out with approximate concentrations of the ions, deviations from the above value of the solubility to the extent of 5–10 per cent. may be allowed.

Gas Cells.—In the case of the cells already discussed, we have been dealing with reversible soluble electrodes. But by the use of insoluble electrodes, *e.g.* platinum, reversible electrodes can also be prepared whereby we are enabled to measure the e.m.f. of other reactions in which metal ions are not involved, *e.g.* combination of hydrogen and oxygen. Thus, for example, a platinum electrode surrounded by hydrogen or oxygen gas and partly immersed in an electrolytic solution containing H^+ and O'' (or OH'),¹ acts as a reversible hydrogen or oxygen electrode, the potential of which depends on the concentration of the H^+ or O'' (or OH') in the solution, as well as on the pressure of the gas around the electrode. Cells of this nature, the e.m.f. of

¹ The oxygen ions, O'' , are derived from a dissociation of the OH' according to the equation $4 \text{OH}' \rightleftharpoons 2 \text{O}'' + 2 \text{H}_2\text{O}$,

which is due to interaction between gases, are known as gas cells. Although, as already stated, the theory of these cells is the same as for the cells already described, several experiments should nevertheless be performed with the gas cells on account of the importance of their applications. For this purpose we shall employ hydrogen electrodes.

If we have a cell of the type—

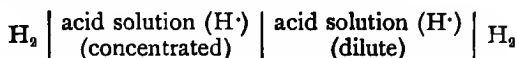

then the e.m.f. will be given by the equation (p. 239)—

$$e = \frac{v}{u + v} \times 2 \times 0.058 \log_{10} \frac{c_1}{c_2}$$

for temperatures between 15° and 20°. Whereas, in the cases previously studied, the value of $\frac{v}{u + v}$ was but little different from 0.5 (cf. the silver ion concentration cell), the value of this ratio in the case of acid solutions approximates more nearly to 0.2, on account of the fact that the mobility of H⁺ is very much greater than that of any anion.

Calculating the value of the e.m.f. of the cell—

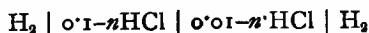

we obtain, for temperatures between 15° and 20°—

$$\begin{aligned} e &= 0.17 \times 2 \times 0.058 \log_{10} \frac{a_1 c_1}{a_2 c_2} \\ &= 0.17 \times 2 \times 0.058 \log_{10} 9.49 \\ &= 0.0193 \text{ volt.} \end{aligned}$$

EXPERIMENT.—*Determine the E.M.F. of a Hydrogen Concentration Cell.*

Preparation of the Electrodes.—As electrodes, oblong strips of platinum foil may be used. The foil is welded to a piece of platinum wire, which is then sealed into a glass tube; and

electrical connection with the outside circuit is made with the help of a small quantity of mercury. In order to obtain constant values of potential between electrode and solution, it is necessary or, at least, advisable, to coat the electrode with platinum black. This is best done electrolytically in the manner described on p. 171. Further, since the amount of hydrogen absorbed will depend on the thickness of the coating, care should be taken that the deposits on the two electrodes to be used in the concentration cell are as nearly as possible the same. The current used in platinizing the electrodes should therefore pass for equal times in each direction.

Before the electrodes are platinized, they should be cleaned by treatment for 5 minutes with a warm solution of potassium bichromate acidified with sulphuric acid, and then well washed with distilled water. After being platinized, the electrodes may

be freed from occluded chlorine by immersion for quarter of an hour in a mixed solution of ferrous and ferric salts acidified with sulphuric acid. They are then thoroughly washed with distilled water, and kept in distilled water till required for use.

When platinum foil is used for the electrodes, many hours may be required for the equilibrium between the gas and the solution, and therefore for a constant electrical potential, to be established. It is better therefore to employ thin films of platinum¹ on glass. These electrodes can be prepared in the following manner:—

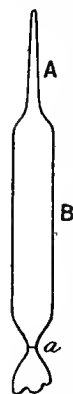

FIG. 82.

A piece of glass tubing (preferably of Jena glass), of length and diameter adapted to the electrode vessel to be employed, is drawn out as shown in Fig. 82; the end of the narrow portion A being sealed, while the other end of the tube is left open. By means of a small brush, coat

¹ Iridium is still better. The iridium electrode can be prepared in a similar manner to the platinum one.

the surface of the tube down to *a* with "liquid platinum," and warm the tube carefully in the hot air above a non-luminous Bunsen flame, meanwhile slowly rotating the tube so that the coating becomes uniform. The liquid should then be slowly dried off, by passing the tube fairly rapidly through the lower portion of the flame, care being taken that the heating is not so great as to cause the film to blister. As the drying proceeds, the film becomes darker in colour, and at last appears almost black; but care should still be exercised in the heating until white metallic platinum begins to make its appearance. The tube should now be heated more strongly; and when all the organic matter has been burned away, the whole tube should be raised to a bright red heat in the blow-pipe flame. Do not, however, heat so strongly that the glass softens and the tube becomes deformed. If the coating has not been sufficiently burned on the tube it will probably peel off when used as an electrode. The proper amount of heating can only be learned by experience.

If the deposit of platinum is too thin, another may be put in the same manner, after allowing the tube to cool. When a satisfactory coating has been obtained, seal off the tube at *a*.

The electrode is now cemented by means of sealing-wax or Chatterton compound into a narrower glass tube widened out at the end so as to fit down on the shoulder of the electrode; and the end of *A* must pass up through the cement to enable electrical contact to be made with a copper wire by means of a little mercury (Fig. 83). Before use, the electrode must be platinized as described above; and when not in use, should be kept in distilled water.

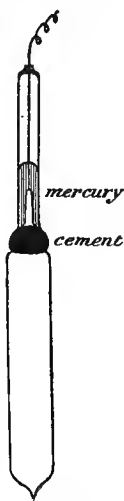

FIG. 83.

The Electrode Vessel.—For the purpose of the following

experiments, the most convenient form of electrode vessel is that shown in Fig. 84. It consists of a fairly wide glass tube, A, into the bottom of which a bent glass tube, B, through which the gas can be passed, is sealed. The electrode E is fixed in the tube by means of a rubber stopper, and connection between the electrolytes is established by means of the bent tube C, which is furnished with a stop-cock. There is another side tube, D, to which a small vessel, F, containing mercury to act as an air-trap, can be attached.

The electrode vessel can be most conveniently supported in a small brass clamp screwed into a block of wood (Fig. 85).

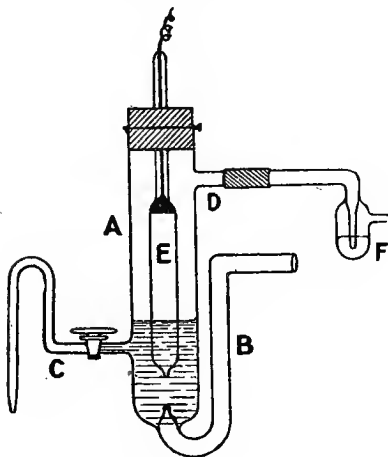

FIG. 84.

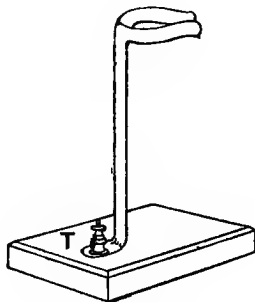

FIG. 85.

This block of wood also carries a double terminal, T, to which the thin copper wire from the electrode, and also the wire making connection with the rest of the circuit, can be attached.

Carrying out the Measurement.—Prepare two solutions of

hydrochloric acid, one deci-normal, the other centi-normal. Fill two electrode vessels with deci-normal HCl, and fix them in position in their holders. With the stop-cocks on C open, and the exit tubes of F closed, pass hydrogen slowly into the electrode vessels through B, thereby forcing acid out through C. Before entering the electrode vessels, the hydrogen should be made to pass through a solution of potassium permanganate, then through a saturated solution of mercuric chloride, and lastly through a solution of hydrochloric acid of the same strength as is contained in the electrode vessel. When the level of the acid in the latter has fallen to just above the level of the side tubes C, the stop-cocks are closed and the gas now allowed to escape through F. Continue the passage of the gas for about 30 minutes. In this way, the greater portion of the electrodes is surrounded by hydrogen gas, while the lower end, about 1 cm. in length, dips into the acid. The supply of hydrogen is now cut off, and the electrodes allowed to remain surrounded by gas for some time, when it will probably be found that hydrogen is absorbed by the electrodes, as shown by the movement of the mercury in the trap-tubes F. If this is so, be careful not to allow air to enter the apparatus, and pass hydrogen again through the apparatus for 15-30 minutes, until the gas is no longer absorbed in appreciable amount by the electrodes.

The ends of the side tubes C are now placed in a deci-normal solution of hydrochloric acid, the glass stop-cocks are opened, and a measurement made to determine whether or not the cell possesses an e.m.f. due to difference in the nature of the electrodes. If any e.m.f. is exhibited, the passage of hydrogen through the cell must be renewed, until no e.m.f. is shown. When this is the case, we may consider that the two electrodes are voltaically the same, and may then proceed to the measurement of the e.m.f. of a concentration cell.

In one of the electrode vessels, the deci-normal hydrochloric

acid is replaced by centi-normal acid, and hydrogen passed in as before, and the e.m.f. of the cell—

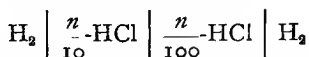

determined. While the measurement is being made, hydrogen may be passed in a slow stream through both electrode vessels, in which case the stop-cocks on C must remain closed;¹ or the passage of the gas may be interrupted and the stop-cocks opened. The intermediate conducting solution may be either deci- or centi-normal HCl.

As the e.m.f. of this cell is small (see p. 243), it will be necessary to combine it either in series with or in opposition to the standard cell. Measurements of the e.m.f. should be made from time to time, say every quarter of an hour, until the e.m.f. is constant. The passage of hydrogen through the cell should be continued meanwhile.

The value of the e.m.f. thus found should be compared with the theoretical value; and, further, from the value obtained, the concentration of H⁺ in the centi-normal solution should be calculated. For the degree of ionization of HCl we may take the following values:—

In deci-normal solution = 0.91.

In centi-normal solution = 0.96.

Ionization of Water.—Another hydrogen concentration cell may be studied, not only on account of the importance of the result, but also because it will afford us an opportunity of calculating the contact potential between two binary electrolytes. This cell has the following construction:—

¹ If no vaseline is used on the stop-cocks and the latter are wetted by the acid solutions, the latter is generally sufficient to ensure electrolytic connection and to allow of the passage of the current. When this is not so, the passage of the gas through the electrode vessels must be discontinued, and the stop-cocks opened.

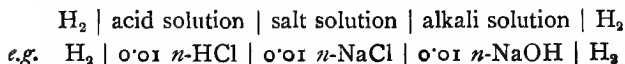

the salt solution being inserted between the acid and alkali to prevent alteration in the concentration by the interaction of the latter.

In accordance with the law of mass action—

$$\text{conc. of } H^{\cdot} \times \text{conc. of } OH' = k. \text{ conc. of } H_2O$$

and as the concentration of the unionized water is large compared with the concentration of the ions, we can write $k. \text{ conc. of } H_2O = K$. Hence, $\text{conc. of } H^{\cdot} \times \text{conc. of } OH' = K$. Now, no matter how much the concentration of OH' is increased, the aqueous solution must still contain a finite concentration of H^{\cdot} ; and, consequently, in the above cell we have a hydrogen concentration cell, in which the concentration of H^{\cdot} on one side (alkali) is very small.

In the case of the above cell, the e.m.f. which is measured is not equal merely to the sum of the electrode potentials, but includes also the contact potentials between the solutions of acid and salt, and alkali and salt. These potentials, unlike those between most simple salts (such as those previously studied), are by no means negligible, on account of the great difference in the mobilities of the hydrogen and hydroxyl ions as compared with those of sodium and chloride ions. These contact potentials, can, however, be calculated as follows, assuming complete ionization of the electrolytes, and also equivalent concentration throughout—conditions which are very approximately satisfied in the case of the above solutions.

For the contact potential between two completely ionized binary electrolytes, giving only monovalent ions, we have—

$$e = \frac{RT}{F} \cdot \log_e \frac{u' + v''}{v' + u''} \text{ volt}$$

For a mean temperature of 18° , this may be taken as equal to (cf. p. 237)—

$$e = 0.058 \log_{10} \frac{u' + v''}{v' + u''} \text{ volt}$$

In these formulæ, u' and u'' represent the mobilities of the cations, v' and v'' those of the anions.

The mobilities of the ions with which we are concerned here, may be taken as—

$$\begin{aligned} \text{H}^{\cdot} &= 318 \\ \text{Na}^{\cdot} &= 44.4 \\ \text{Cl}' &= 65.9 \\ \text{OH}' &= 174 \end{aligned}$$

From these numbers we obtain the following values of the contact potentials :—

$$\begin{aligned} \text{HCl} - \text{NaCl} &= 0.0314 \text{ volt} \\ \text{NaCl} - \text{NaOH} &= 0.0172 \text{ ,,} \end{aligned}$$

As these potentials both act in opposition to the electrode potentials, the e.m.f. of the above cell will be less than the sum of the electrode potentials by 0.0486 volt (say 0.049 volt), and this number must therefore be added to the measured e.m.f. in order to obtain the e.m.f. of the concentration cell freed from the contact potentials between the liquids.

For the determination of the concentration of H^{\cdot} in the alkali solution, therefore, we obtain—

$$e + 0.049 = 0.058 \log_{10} \frac{c_1}{c_2}$$

where e is the e.m.f. measured.

From the determination of the e.m.f. of the above cell, then, we obtain the concentration of H^{\cdot} in the alkali; from the known concentration of the alkali (0.01 normal) we obtain the concentration of OH' , by multiplying by the degree of ionization (0.92). Hence, we can calculate the value of the product

$C_{H^+} \times C_{OH^-} = K$. Since in pure water $C_{H^+} = C_{OH^-}$, it follows that $C_{H^+} = C_{OH^-} = \sqrt{K}$, which gives us the degree of ionization of water. At 18° , $C_{H^+} = C_{OH^-} = (\text{approximately}) 1 \times 10^{-7}$.

EXPERIMENT.—*Determine the E.M.F. of the Cell—*

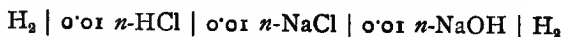

and calculate therefrom the degree of ionization of water. The measurement is carried out in exactly the same manner as described for the simple hydrogen concentration cell (p. 246) Use sodium hydroxide free from carbonate (p. 197).

By means of similar cells one can also measure the degree of hydrolysis of salts. Thus from determinations of the E.M.F. of the cells—

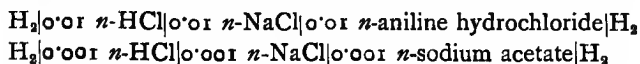

one can calculate the concentration of hydrion and hydroxidion in the solutions of aniline hydrochloride and sodium acetate respectively, and therefrom the degree of hydrolysis of the salts.

Decomposition Potential of Salts.—When a dilute solution of zinc sulphate is electrolyzed between platinum electrodes, zinc is deposited on the cathode and oxygen is liberated at the anode. We thus obtain a cell of the type $Zn | \text{solution} | O_2$, and this cell exhibits a certain E.M.F. due to the tendency of the zinc and oxygen to pass back into the ionic state. The E.M.F. of the cell acts in the opposite direction to that of the electrolyzing current. In order, therefore, that continuous electrolysis may take place, an E.M.F. must be applied to the electrodes sufficient to overcome the back E.M.F. of the products of electrolysis, and the potential which is just sufficient to produce continuous electrolysis is called the *decomposition potential* of the salt. It will obviously be equal to the sum of the electrode potentials plus the bath

potential, or the potential fall between the electrodes, which is given by the expression $I.R.$ where I is the current passing, and R the resistance of the electrolyte between the electrodes.

Since the electrode potential, as we have already seen, depends on the concentration of the ions in the solution, so also the decomposition potential will depend on the concentration.

The decomposition potential of a salt can be most simply determined by measuring the current which passes when an

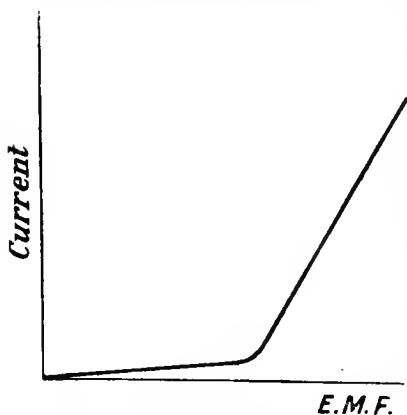

FIG. 86.

E.M.F. of gradually increasing strength is applied to the electrodes.

At first, an almost constant and very small current, the *residual current*, is obtained, but after the applied E.M.F. reaches a certain value, the current begins rapidly to increase with increase in the applied E.M.F. The point where this rapid increase in the electrolyzing current

commences, is the *decomposition potential* of the particular solution. If one plots the current strength against the applied E.M.F. a curve such as is shown in Fig. 86 is obtained. When the break in the curve is not sharp, the value of the decomposition potential is obtained by producing the almost horizontal branch to cut the production of the almost vertical branch.

It is frequently also desired to obtain the value of the discharge potential of the anion and cation separately. This can readily be effected with the help of an auxiliary electrode, as described below.

EXPERIMENT.—*Determine the Decomposition Potential of a Solution of Zinc Sulphate.*

The apparatus is fitted up as shown diagrammatically in Fig. 87. Two lead accumulators are closed through the resistance R furnished with a sliding contact. A is a milliammeter, furnished with a shunt enabling readings to be taken up to 0.2 or 0.3 ampere. C is the electrolytic cell (a beaker) in which two platinum electrodes are placed. V is a high resistance voltmeter. A solution of $\frac{n}{10}$ zinc sulphate may be employed.

The sliding contact is first placed near the end a of the

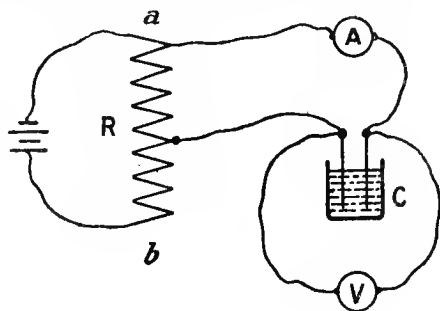

FIG. 87.

resistance so that only a small E.M.F. is applied to the electrodes of the electrolytic cell, and the current passing is read on the milliammeter. The applied E.M.F. is read on the voltmeter V . The sliding contact is then moved in steps towards the end b of the resistance, and at each point the current passing is read on A , and the applied E.M.F. on V . These corresponding values are plotted as shown in Fig. 87, and the value of the decomposition potential read from the curve.

The correction for the fall of potential in the cell may also be applied.

FURTHER EXPERIMENTS.—*Determine the Decomposition Potential of Copper Sulphate (in Deci-normal Solution), of Silver Nitrate (Deci-normal), and of Potassium Silver Cyanide (Silver Nitrate with Excess of Potassium Cyanide).*

EXPERIMENT.—*Determine the Discharge Potential of Zincion and Sulphanion in a Solution of Zinc Sulphate.*

The apparatus is fitted up as shown in Fig. 88. The

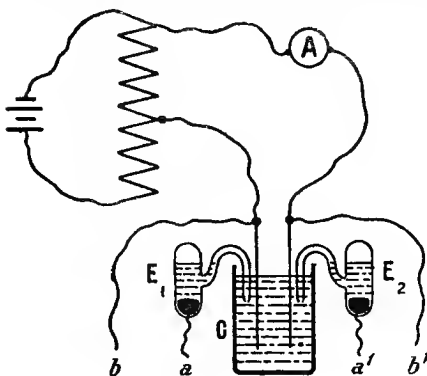
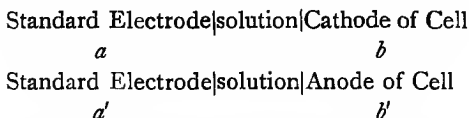

FIG. 88.

circuit with resistance and ammeter is as in the previous experiment. E_1 and E_2 are two standard electrodes, $\text{Hg}|\text{Hg}_2\text{SO}_4$ in $n\text{-H}_2\text{SO}_4$, the side-tubes of which are placed in the solution of zinc sulphate, quite close to the cathode and anode.

By means of the sliding contact, different potentials are applied to the electrodes of the cell C, and the current is read on the ammeter A. At the same time one determines the E.M.F. of the combinations—



by means of the ordinary Compensation method (p. 214).

By subtracting from the values so found, the potential of the standard electrode, one obtains the potential of the

cathode and anode respectively. The values so obtained for different values of applied E.M.F. are plotted against the current, and one obtains two curves, one for the cathode and one for the anode, similar to that shown in Fig. 86. The break in the curve corresponds to the discharge potential of the cation and anion, and by adding these values the decomposition potential of the salt is obtained

The potential of the standard mercurous sulphate electrode used above is + 0.956 volt, the mercury being positive to the solution.

References.—For solubility determinations: Goodwin, *Zeitschr. physikal. Chem.*, 1894, **18**, 577; Abegg and Cox, *ibid.* 1903, **48**, 1. For stability of complex ions: Bodländer and Fittig, *Zeitschr. physikal. Chem.*, 1902, **30**, 597. For determinations of hydrolysis of salts: Denham, *Trans. Chem. Soc.*, 1908, **93**, 41. For decomposition potentials: Bennowitz, *Zeitschr. physikal. Chem.*, 1910, **72**, 202.

CHAPTER XII

VELOCITY OF CHEMICAL REACTION IN HOMOGENEOUS SYSTEMS

THE fact that all chemical reactions require time for their accomplishment gives rise to the problems: What are the laws governing the velocity of a chemical reaction, and how can the rate of change be measured?

As regards the laws by which the velocity of a chemical reaction is governed, the basis of these is to be found in Guldberg and Waage's law of mass action. According to this law, the velocity with which a reaction occurs is, at any moment, proportional to the existing concentrations of the reacting substances. If we neglect here the cases where the reaction is reversible to an appreciable extent, and consider only those in which the reaction takes place with practical completeness in one direction, we can express the velocity of a reaction by the equation—

$$\frac{dx}{dt} = k(a - x)(b - x)(c - x) \dots$$

where x represents the amount, in gram molecules, of the substances changed in time t , $\frac{dx}{dt}$ the velocity of the reaction at any given moment, and $a, b, c \dots$ represent the initial concentrations (in gram molecules per litre) of the interacting substances.

In the cases where only one molecular species undergoes change (monomolecular reaction or reaction of the first order), the velocity of the reaction will be represented by the equation $\frac{dx}{dt} = k(a - x)$; from which, on integration, we obtain the expression—

$$k = \frac{1}{t} \cdot \log_e \frac{a}{a-x} = 2.302 \times \frac{\log_{10} a - \log_{10} (a-x)}{t}$$

When two molecular species undergo change in concentration during the reaction (bimolecular reaction or reaction of the second order) the velocity of the reaction will be expressed by the equation $\frac{dx}{dt} = k(a-x)(b-x)$, which, on integration, yields the expression—

$$k = \frac{1}{(a-b)t} \cdot \log_e \frac{(a-x)b}{(b-x)a} = \frac{2.302}{(a-b)t} \cdot \log_{10} \frac{(a-x)b}{(b-x)a}$$

When the initial concentrations, a and b , are the same, the corresponding equations are $\frac{dx}{dt} = k(a-x)^2$ and $k = \frac{1}{t} \cdot \frac{x}{a(a-x)}$

The expressions for the velocity of reactions of a higher order, in which the concentration of three or more molecular species undergoes change, can be obtained in a similar manner. We shall not deal, however, with these here.

As regards the methods by which the progress of a chemical reaction can be followed, use can be made of the ordinary methods of chemical analysis; or physical methods may be employed in those cases where the reaction is accompanied by a sufficiently definite or great change in the physical properties of the system. The actual method employed in any given case, will depend, of course, on the reaction which is being studied, and one will naturally choose that method which can be carried out most conveniently and quickly, and at the same time with

sufficient accuracy. In general, one would employ a physical method, where possible, on account of the fact that there is less danger, or no danger, of disturbing the condition of the reacting system; a danger which is by no means absent when a chemical method, depending as it must on the addition of other substances to the reacting system, is employed.

Of the physical methods which have received application for this purpose, we may mention: measurement of the change in volume of the system, and the change of the rotary power, in the case of optically active substances. To these may be added, determination of the volume of gas evolved or absorbed during the reaction.

Of the chemical methods, one may employ those either of volumetric or of gravimetric analysis; the former being employed, where possible, on account of the convenience and rapidity with which they can be carried out. In the case of reactions which proceed with considerable velocity, it may be necessary, when chemical methods of analysis are employed, to adopt means for stopping the reaction at a particular moment, or for so greatly reducing the velocity that practically no change occurs during the time necessary for carrying out the analysis.

A.—REACTIONS OF THE FIRST ORDER

Hydrolysis of an Ester in presence of an Acid.—

When an ester, such as methyl acetate, is acted on by water, it is partially converted into alcohol and acid, according to the equation—

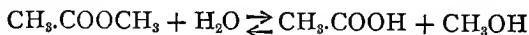

and when the amount of water is relatively large, the reaction takes place practically completely, as represented, from left to right. This decomposition or hydrolysis of an ester, which

takes place more or less rapidly even with pure water, is accelerated by the presence of acids; and the acceleration is, in dilute solutions, proportional to the concentration of the hydrion. It is evident, therefore, that determinations of the velocity of hydrolysis of esters under the influence of acids, may be used for the purpose of determining the concentration of the hydrion in a solution, or for determining the strength of an acid.

The following experiments will illustrate this:—

EXPERIMENT.—*Determine the Relative Strengths of Hydrochloric and Sulphuric Acids.*

A standard solution of baryta, approximately $\frac{n}{20}$, should be prepared (p. 162), and its titre determined by means of pure succinic acid, using phenolphthalein as indicator. By means of this baryta solution, prepare also semi-normal solutions of hydrochloric acid and sulphuric acid, the solutions being in all cases made up with CO_2 -free water (p. 161). Procure also two small Erlenmeyer flasks of about 40–50 c.c. capacity, preferably made of Jena glass. These should be washed clean, and then subjected to the action of steam for 10–15 minutes (p. 170), and thereafter dried; and they should also be fitted with corks, previously soaked in melted paraffin, and be weighted by means of leaden plates. The latter may be attached to the flasks either by turning up the edges of the lead round the flask, or by means of thin copper wire passing through the corners of the lead plate and twisted round the

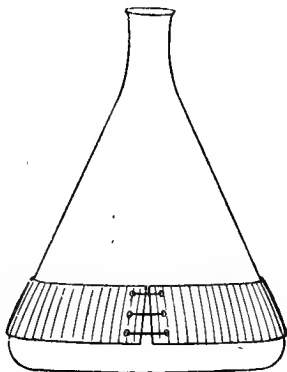

FIG. 89.

neck of the flask; or a band of lead may be made to encircle the lower portion of the flask (Fig. 89).

Procure, further, one or two Erlenmeyer flasks of 50-100 c.c. capacity, fitted with corks, in which to carry out the titrations; two pipettes, the one made to deliver 1 c.c., the other to deliver 2 c.c.; and a small stoppered bottle with pure methyl acetate.

Into the two small Erlenmeyer flasks, prepared as described above, pipette 20 c.c. of the $\frac{n}{2}$ -HCl and $\frac{n}{2}$ -H₂SO₄ respectively, and place them in a thermostat, the temperature of which has been adjusted to 25.0° (p. 71). The flasks may be either suspended from the side of the thermostat or placed on a tray of strong wire-netting or perforated zinc plate, which should be placed at such a depth that the flasks are immersed up to the neck in the water of the thermostat. The bottle containing the methyl acetate should also be placed in the thermostat.

After, say, ten minutes, when the liquids will have assumed the temperature of the bath, pipette 1 c.c. of the methyl acetate into one of the flasks of acid, shake well, and immediately withdraw 2 c.c. of the solution. This is allowed to run into 20-30 c.c. of CO₂-free water¹ (contained in one of the larger Erlenmeyer flasks), in order to arrest the reaction, and the acid titrated as soon as possible by means of the baryta solution. Note the moment, to the nearest second, at which the solution is run into the water; this is taken as the starting-point of the reaction.

Having thus determined the initial titre of the one acid solution, 1 c.c. of the methyl acetate is pipetted into the second acid, and the initial titre determined as in the previous case.

¹ In order to arrest the reaction still more effectually, the water may be cooled by placing the flask in a basin of ice. This is, however, not absolutely necessary unless the titration with baryta is delayed unduly.

About 10–15 minutes after the first titration, again withdraw 2 c.c. of the mixture from each of the flasks, and determine the titre as before, noting, in each case, the moment at which the reaction is arrested. Further titrations are made from time to time in the same manner after successive intervals of, say, 20, 30, 40, 60, 120 minutes. The remainder of the reaction-mixtures should then be left in the thermostat for 48 hours, when the final titration may be made.

The value of the velocity constant in the two cases can then be calculated in accordance with the formula for a monomolecular reaction (p. 257). Since the initial concentration a is proportional to $T_{\infty} - T_0$, where T_{∞} is the final titration, and T_0 the initial titration in cubic centimetres of the baryta solution; and since $a - x$, the concentration at time t_n (counted in minutes from the commencement of the reaction) is proportional to $T_{\infty} - T_n$, where T_n is the titration at time t_n , we can write—

$$k = \frac{2.30}{t_n} [\log_{10} (T_{\infty} - T_0) - \log_{10} (T_{\infty} - T_n)]$$

Instead of counting the time and the change of concentration from the beginning of the reaction, one can also reckon them from titration to titration. If T_x and T_y are the titrations at the times t_x and t_y , the velocity constant is given by the expression—

$$k = \frac{2.30}{t_y - t_x} [\log_{10} (T_{\infty} - T_x) - \log_{10} (T_{\infty} - T_y)]$$

The values of the “constant” in any given series should not differ from the mean of all the values by more than 3–4 per cent. The first value of the “constant,” however, generally shows greater deviations, and may be excluded. The results should be tabulated under the headings, *time, titration, k*; the numbers in the first column giving the time in minutes from

the commencement of the reaction at which the particular titration was made.

The value of the velocity constant in the case of the mixture 20 c.c. $\frac{n}{2}$ -HCl + 1 c.c. methyl acetate at 25° is 0.0032. From the known values of the degree of ionization of the acids (for $\frac{n}{2}$ -HCl, $\alpha = 0.85$; for $\frac{n}{2}$ -H₂SO₄, $\alpha = 0.53$), determine in how far your measurements indicate proportionality between the value of the velocity constant and the concentration of hydrion in the solutions; and conversely, assuming direct proportionality to exist, calculate from your values of the velocity constants the degree of ionization of hydrochloric and sulphuric acids in semi-normal solution.

It will also be found very instructive (see p. 273) to carry out another measurement with the same amount of, say, hydrochloric acid as used above, but with double the quantity (2 c.c.) of methyl acetate. This experiment should, indeed, be carried out alongside of those just described.

EXERCISE.—From the measurements made above, plot the values of x (the amount of reacting substance changed), against the corresponding values of the time, in rectangular co-ordinates. Draw a smooth curve through the points so obtained, and from the portion of the curve at which concordance with the observed values is best, calculate the value of the velocity constant. From the form of the curve, also, determine the influence of titration and time errors at different stages of the reaction.

Velocity of Inversion of Cane Sugar.—Another reaction of the first order is the inversion of cane sugar, the velocity of which is also accelerated by acids to a degree which is approximately proportional to the concentration of the hydrion. Consequently, this reaction can also be employed for the determination of the concentration of hydrion in a solution.

In order to follow the course of the reaction, use is made of the property of the solution of rotating the plane of polarized light. Whereas cane sugar is dextro-rotary, invert sugar (mixture of glucose and fructose) is lævo-rotary, so that, as the result of the inversion, the sign of rotation changes from right to left.

If A_0 represents the initial angle, and A_∞ the final angle of rotation, after complete inversion has occurred, the initial amount of cane sugar will be proportional to the total change in rotation, *i.e.* to $A_0 - A_\infty$. Similarly, at time t_n , if the angle of rotation is A_n , the amount of cane-sugar present will be represented by $A_n - A_\infty$. Hence, in accordance with the formula for a monomolecular reaction, we obtain the expression—

$$k = \frac{2.30}{t_n} [\log_{10} (A_0 - A_\infty) - \log_{10} (A_n - A_\infty)]$$

or, if the constant is calculated from reading to reading—

$$k = \frac{2.30}{t_y - t_x} [\log_{10} (A_x - A_\infty) - \log_{10} (A_y - A_\infty)]$$

In carrying out the calculation, the values of the angles must be given their proper sign, rotations to the right being reckoned +, and those to the left —.

EXPERIMENT.—*Determine the Velocity Constant of Inversion of Cane Sugar by Semi-normal Hydrochloric Acid.*

Before commencing this experiment, read through the section on polarimetric measurements, p. 112.

Prepare a solution of cane sugar by dissolving 20 gms. of pure cane sugar in water and making the volume up to 100 c.c.; and, if necessary, filter the solution so that it is quite clear. Add a crystal of mercuric iodide or of camphor as preservative. Prepare, also, a normal solution of hydrochloric acid. Place about 25 c.c. of the sugar solution and

an equal volume of the acid in separate flasks which have previously been steamed out and dried (p. 170), and stand the latter in a thermostat at 25° .

After having set up the polarimeter and determined the zero,¹ place a jacketed observation tube in the polarimeter, and cause water (at 25°) to circulate through the mantle of the observation tube (p. 79). The circulation of water through the tube must be so regulated that the temperature remains constant to within 0.1° during the whole of the experiment. This should first be tested with the observation tube full of water, in which the bulb of a thermometer is immersed.

The circulation of water having been satisfactorily regulated, the observation tube is dried and replaced in the polarimeter. When the temperature has again become constant, mix the acid and sugar solutions, and, as soon as possible, pour the mixture into the observation tube. Determine the angle of rotation, and note the time at which the reading is made.

As the angle of rotation alters rather quickly during the first few minutes, a series of five or six readings should be made, one after the other, and the time noted at which the first and last readings are made. The mean value of the angles read, and the middle point of the time period between the first and last readings, should be taken as the initial value of the rotation (A_0) and the starting-point of the reaction, respectively. Further readings, up to the number of eight or ten, of the angle of rotation should be made after periods gradually lengthening from ten minutes to two hours, as in the previous experiment. The final reading should again not be taken until after at least forty-eight hours, the tube being kept during this time at 25° by placing it in the thermostat.

¹ It will not be necessary to introduce the zero correction, because we are here dealing with differences of angles; but the zero point should, nevertheless, be determined before and after the experiment in order to make sure that it does not change during the progress of the experiment.

The value of the velocity constant should be calculated according to one or other of the expressions given on p. 263, and the results tabulated under the headings *time, rotation, k*.

The "constant" for a 20-per-cent. sugar solution, when mixed with an equal volume of normal hydrochloric acid at 25°, is 0.00472.

Similar measurements should be carried out with corresponding solutions of other acids, and the values of the constants so obtained compared.

Application.—As the experiments just described will have shown, the measurement of the velocity of hydrolysis of an ester, or of the inversion of cane sugar in presence of acids, gives us a means of determining the concentration of hydron in a solution; and as an illustration of the application of such measurements for this purpose, we may determine the degree of hydrolysis of a salt of a weak base and strong acid (cf. p. 158).

When such a salt as carbamide hydrochloride is dissolved in water, partial hydrolysis takes place with formation of free (practically unionized) carbamide and hydrochloric acid. If we consider the hydrochloric acid as being completely ionized, then it will be clear that the degree of hydrolysis of the salt will be measured by the amount of free hydron produced in the solution. The reactions which we have just studied afford us a means of determining this, all that is necessary being to determine, first of all, the velocity of hydrolysis of methyl acetate or the inversion of cane-sugar in solutions containing a known concentration of hydron, and then in a solution of the salt of known concentration.

EXPERIMENT.—*Determine the Degree of Hydrolysis of Carbamide Hydrochloride.*

Determine, in the manner described on p. 259, the velocity constant of hydrolysis of methyl acetate first of all in a semi-normal solution of hydrochloric acid, and then in a solution of semi-normal hydrochloric acid in which an amount of

carbamide exactly equivalent to the amount of hydrogen chloride present in the solution, has been dissolved; the amount of methyl acetate added and the temperature of the experiment being the same in both cases. It is best, indeed, to carry on the two experiments side by side.

The degree of hydrolysis is given by the ratio of the concentration of free acid present in the solution to that which would be present if the salt were completely hydrolyzed. The latter is, of course, measured by the velocity constant (k_1) in the pure acid solution, and the former by the velocity constant obtained after the addition of an equivalent amount of carbamide (k_2). Hence we obtain $x = \frac{k_2}{k_1}$, where x is the degree of hydrolysis.

With the solutions given above, $k_1 = 0.0032$, and $k_2 = 0.00208$. Hence, in semi-normal solution at 25° , the degree of hydrolysis of carbamide hydrochloride is 0.65; that is to say, 65 per cent. of the salt is hydrolyzed.

More Accurate Method.—We have assumed above that the velocity constant of hydrolysis of methyl acetate is proportional to the free acid present, but this is only approximately true. The concentration of hydrion will not be equal to the total concentration of acid, owing to the presence of a salt of the acid; and, further, the velocity will also be affected by the presence of the neutral salt. These two factors can be corrected for in the following manner. A determination of the approximate degree of hydrolysis is carried out as described above, by which the degree of hydrolysis is found to be apparently 65 per cent. A solution of hydrochloric acid and sodium chloride is then prepared so that it is semi-normal with respect to total chloride, but contains only 65 per cent. of this as free acid. The velocity constant obtained with this solution is then compared with the constant obtained with the solution of carbamide hydrochloride.

The degree of hydrolysis can also be obtained by studying the velocity of inversion of cane sugar. The procedure to be adopted in this case will be quite clear from what has just been said, and from the description of the experiment on p. 263.

These two methods of determining the degree of hydrolysis can be used in the case of other salts formed from a weak base and a strong acid, provided the base is very weak. In the case of salts of bases of the strength, say, of aniline, the method is not suitable (cf. p. 158).

Decomposition of Diazonium Salts.—In illustration of another method of following the course of a reaction, we may study the decomposition of diazonium salts, e.g. benzene diazonium chloride. When this salt is warmed with water, it undergoes decomposition according to the equation—

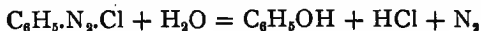

and we can follow the course of the decomposition by measuring the volume of nitrogen evolved from time to time.

Since the concentration of benzene diazonium chloride in the solution is proportional to the total volume of nitrogen which the solution is capable of yielding, we can calculate the velocity constant of the decomposition by means of the formula—

$$k = \frac{2.30}{t_n} [\log_{10} V_\infty - \log_{10} (V_\infty - V_n)]$$

where V_∞ is the total volume of gas obtained, and V_n the volume of gas collected up to time t_n .

EXPERIMENT.—*Determine the Velocity of Decomposition of Benzene Diazonium Chloride.*

Prepare a solution of benzene diazonium chloride as follows: Dissolve 6.64 gms. of aniline in 21.4 c.c. of hydrochloric acid (sp. gr. = 1.16); cool in ice-water, and add gradually from a dropping-funnel a cold solution of 4.9 gms. of sodium nitrite

in 75 c.c. of water. After the addition of the sodium nitrite, make the solution up to 1 litre. Place 30–35 c.c. of this solution in a tube of about 3 cms. in diameter, into which a side tube, B, of about 1 mm. bore is sealed (Fig. 90). The tube, which should be well cleaned and dried before use, should

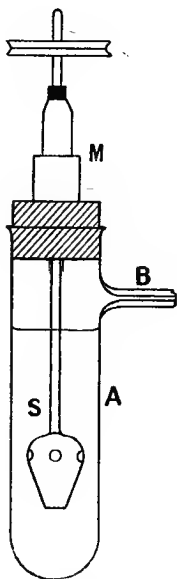

FIG. 90.

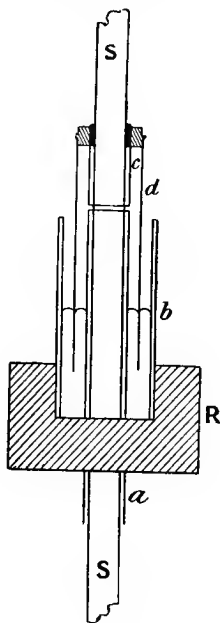

FIG. 91.

be chosen of such a length that the air-space above the solution is small. The capillary side tube B is connected with a Hempel gas burette, or ordinary burette, exactly as shown in Fig. 11, p. 50. The mouth of the tube A is closed by a rubber stopper through which a stirrer, S, passes, and the latter is furnished with a mercury seal, M, to prevent the escape of gas.

The construction of such a mercury seal, which is of great value in physico-chemical work, will be readily understood from Fig. 91. Through the rubber stopper, R, there passes a tube, a , which is slightly wider than the stem of the stirrer S. Passing about halfway through the rubber stopper is the moderately wide tube b , which forms a cup round the tube a . Attached by corks or rubber stoppers (rubber tubing) to the upper portion of the stem of the stirrer, are two tubes, c and d , the former of which is of the same diameter as a , while the latter has a width intermediate between that of a and b . It should be long enough to reach down nearly to the bottom of the mercury cup formed by b . Mercury is poured into the tube b so as to rise to about 1 cm. above the lower end of d . In this way a joint is obtained which, while allowing the stirrer to be rotated, prevents escape of gas from the inside of the tube.¹ The upper end of the tube a and the lower end of c should be cut straight, and the ends rounded in a flame. To reduce the friction, the stem of the stirrer where it passes through the tube a should be well coated with vaseline.

The solution of benzene diazonium chloride having been placed in the tube A (Fig. 90), the stirrer is inserted, and the apparatus then fitted together, the side tube B being connected with a gas burette, as shown in Fig. 11. The tube with the diazo-solution is immersed up to the level of the cork in a thermostat, the temperature of which is regulated at about 30°, and the stirrer is set in fairly rapid motion by means of an electric motor or engine. During this time the tube with the solution should be in open communication with the air, and the gas evolved allowed to escape. After 5-7 minutes, communication with the gas burette is effected while that with the outside air is stopped, and the time at which this is done is noted.

¹ Provided, of course, the pressure is not allowed to become so great as to force air out through the mercury. Attention should be paid to this.

This is taken as the starting-point of the reaction. Gas will now collect in the burette, and its volume should be read off at intervals of about 30 minutes. The temperature of the gas and the height of the barometer should also be noted.

The end point of the reaction is determined by repeatedly immersing the tube with the reaction mixture in a large beaker of hot water, until, on cooling again to the temperature of the experiment, there is no further increase in the volume of gas evolved.

The velocity constant of the decomposition is then calculated by means of the equation given on p. 267, the results being tabulated under the headings, *time; volume of N₂ in c.c.; temperature; barometer; corrected volume of N₂ in c.c.; k.*

B.—REACTIONS OF THE SECOND ORDER

Saponification of Esters by Alkalis.—In aqueous solution in presence of alkali, esters undergo hydrolysis, or *saponification*; and the velocity of saponification is approximately proportional to the concentration of OH'. The reaction is represented by the equation—

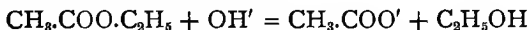

This reaction differs, as will be seen, from the hydrolysis of esters in presence of acid, by the fact that the concentration of the catalyst (OH') does not remain constant during the reaction, but gradually diminishes.

EXPERIMENT.—*Determine the Velocity of Saponification of Ethyl Acetate with Sodium Hydroxide.*

The measurement of the velocity of this reaction is carried out in a manner very similar to that used with methyl acetate and acid. As, however, hydrolysis takes place with very much greater velocity in presence of alkalis than in the presence of acids, the measurement is more difficult.

Place 50 c.c. of $\frac{n}{60}$ -solution of ethyl acetate in an Erlenmeyer flask (capable of holding about 100 c.c.), which has previously been steamed out and dried. The flask is fitted with a paraffined cork and placed in a thermostat at 25°. Into another flask, similarly prepared, are introduced 50 c.c. of $\frac{n}{30}$ - or $\frac{n}{40}$ -NaOH (free from carbonate, see p. 197). When these two solutions have acquired the temperature of the bath, the alkali is poured as rapidly as possible into the ester solution, and the mixture well shaken. The mean point of the time-interval required to add the alkali to the ester solution is taken as the initial point of the reaction; and the alkali titre of the mixture corresponding with this moment is calculated from the known strength of the alkali solution, after subtracting the amount of alkali left in the flask. The latter should be determined by titration.

At intervals of 3, 5, and 10 minutes, and then after increasingly greater intervals, 10 c.c. of the reaction mixture are withdrawn and allowed to run into a known volume of standard HCl (say $\frac{n}{20}$), contained in a small flask (or in several small flasks) fitted with a paraffined cork. The mean point of the interval required for the pipette to deliver is taken as the time of stopping the reaction. The excess of acid is titrated with baryta solution. After six or seven titrations have been made, the remainder of the reaction mixture is allowed to stand in the thermostat for twenty-four hours, and the final titration then made.

The velocity constant of saponification is then calculated by means of the formula for a bimolecular reaction (p. 257), viz.—

$$k = \frac{2.30}{T_{\infty} t} [\log_{10} T_t + \log_{10} (T_0 - T_{\infty}) - \log_{10} T_0 - \log_{10} (T_t - T_{\infty})]$$

where T_0 , T_t , T_{∞} are the number of cubic centimetres of acid

solution required to neutralize the alkali in the reaction mixture, at the beginning of the reaction, at the time t minutes, and at the end of the reaction respectively. In order to reduce the values of the constant so obtained to that which would be obtained with normal solutions (containing 1 gm.-equivalent per litre), the above expression must be multiplied by $\frac{v}{N}$, where v is the number of cubic centimetres of the reaction mixture withdrawn each time for titration (in the above case 10 c.c.), and N is the normality (concentration in gram-equivalents per litre) of the hydrochloric acid (in the above case $\frac{1}{20}$).

The results should be tabulated under the headings *time* (in minutes); *number of c.c. of HCl* ($N = \frac{1}{x}$); k .

For ethyl acetate and caustic soda at 25° , $k = 6.94$. Deviations of 5 per cent. from the mean are allowable.

Order of a Reaction.—In employing measurements of reaction velocity for the purpose of determining the mechanism of a chemical reaction, the first point which has to be settled is the order of the reaction. This is not always given by the number of reacting molecules as expressed in the ordinary chemical equation; indeed, it is very seldom so given except in the case of the simplest reactions.

For the purpose of deciding this important point, various methods may be employed. One of the most important consists in making several measurements of the velocity of the reaction, starting with different concentrations of the reacting substances, and determining, in each case, the time required for a certain fraction (say, one-half) of the total change to occur. For a monomolecular reaction, the times are independent of the initial concentration; for a bimolecular reaction they are inversely proportional to the initial concentrations; and, generally, for a reaction of the n th order, they are inversely proportional to the $(n-1)$ power of the initial concentrations.

EXPERIMENT.—*Determine the Order of Reaction in the Case of the Hydrolysis of an Ester in Presence of Acid.*

For this purpose, two experiments should be carried out with methyl acetate and hydrochloric acid (see p. 262), using the same amount of acid in each case, but twice as much methyl acetate in one case as in the other. The results should then be plotted in rectangular co-ordinates, the times of titration (in minutes) being plotted as ordinates, and the corresponding values of $a - x$ (or $T_{\infty} - T_n$), as abscissæ. From the curves obtained, the time should be read off corresponding to the abscissa $a - x = \frac{1}{2}a$ (or $T_{\infty} - T_n = \frac{1}{2}(T_{\infty} - T_0)$). The time so found should be the same in the two cases.

EXPERIMENT.—*Determine the Order of the Reaction* $6\text{HI} + \text{HBrO}_3 = \text{HBr} + 3\text{H}_2\text{O} + 3\text{I}_2$.

Prepare deci-normal solutions of potassium iodide, potassium bromate, and hydrochloric acid; also a centi-normal solution of sodium thiosulphate.

(1) In a clean Erlenmeyer flask of about 300 c.c. capacity, prepared as described previously (p. 259), place 25 c.c. of the solution of potassium iodide, and 100 c.c. of the hydrochloric acid; add 100 c.c. of water. In another flask place 25 c.c. of the solution of potassium bromate, and stand the two solutions in a thermostat at 25°.

Have ready, also, one or two Erlenmeyer flasks containing 40–50 c.c. of ice-cold water.

When the solutions of iodide and bromate have acquired the temperature of the bath, pour the solution of bromate rapidly into the solution of iodide and note the time of mixing. At intervals of two or three, and later of five to ten minutes, 25 c.c. of the reaction mixture is withdrawn and run into the ice-cold water, the mean point of the time-interval required for the pipette to deliver being taken as the point at which the reaction is stopped. The amount of iodine is determined by titration with thiosulphate.

(2) After the first few titrations in the above series have been made, another series is commenced with solutions containing only half the concentration of bromate; that is to say, 50 c.c. of potassium iodide, 200 c.c. of hydrochloric acid, 225 c.c. of water, 25 c.c. of potassium bromate.

From the titrations with thiosulphate, calculate in each case the number of gram-equivalents of HI oxidized at the time of each titration; plot these amounts against the time in minutes, and determine for each series, the time required for one-third or one-half of the HI to be oxidized.

Since the concentrations in the two cases are—

(1) 0.01 gm. equivalents of HI	(2) 0.01 gm. equivalents of KI
0.01 " " KBrO ₃	0.005 " " KBrO ₃
0.04 " " HCl	0.04 " " HCl

it is evident that the product of concentration of the reacting substances (HI and HBrO₃) is twice as great in the first case as in the second. As the reaction is found to be of the second order, the time required for the same fractional amount of transformation to take place, should be approximately twice as great in the second as in the first case.

Additional Exercises.—Other suitable bimolecular reactions which may be studied are the following: Reaction between ethyl bromacetate and sodium thiosulphate (*Trans. Chem. Soc.*, 1905, 87, 481); reaction between hydrogen peroxide and hydriodic acid in the presence of various catalysts (*Zeitscher. physikal. Chem.*, 1901, 37, 257); reaction between potassium persulphate and hydriodic acid (*Zeitschr. physikal. Chem.*, 1898, 27, 477); velocity of esterification of acids by alcohols (*Zeitschr. physikal. Chem.*, 1907, 60, 728; *Trans. Chem. Soc.*, 1910, 97, 19).

CHAPTER XIII

THERMO-CHEMISTRY

WHEN a chemical reaction occurs, it is, in general, accompanied by a measurable heat effect—absorption or evolution of heat—and the amount of heat absorbed or evolved depends (1) on the nature of the reaction; (2) on the condition (temperature and physical state) of the reacting substances; (3) on the amounts of the substances. When, therefore, the last two factors remain the same, the heat effect accompanying a chemical reaction is a constant for that reaction.

In the case of the measurements which we are to consider in this chapter, the effect of temperature will not make itself felt. The physical state of the reacting substances, however, must be specified in each case, unless it is sufficiently obvious from the conditions of the experiment; and the quantity of reacting substance must likewise be stated. As a rule, the heat effect of a reaction is referred to 1 gram-equivalent or to 1 gram-molecule of the reacting substances, or of the substance produced.

The general method by which the heat of a reaction is measured, is to determine the elevation or depression of temperature produced in a known mass of a substance, generally water, of known specific heat. The heat of reaction is thus obtained as a product of specific heat, mass, and change of temperature.

Apparatus.—The essential part of the apparatus is the

calorimeter, in which the reaction, the heat of which is to be measured, takes place. This is generally cylindrical in shape, and is usually made of silver, gilt internally; or of nickel, copper, or aluminium. It should have a capacity of upwards of 500 c.c., in order to contain a sufficiently large amount of the reaction mixture and so help to minimize errors due to radiation. To diminish the actual loss or gain of heat by radiation, the outer surface of the calorimeter is polished, and is surrounded by several other cylindrical and polished metal vessels, and by a doubled-walled vessel filled with water. The different vessels are insulated from one another by wooden blocks (Fig. 92, A).

The change of temperature produced in the water or other liquid contained in the calorimeter is measured by means of a thermometer graduated in hundredths of a degree, and the temperature throughout the liquid is kept uniform by means of a metal stirrer. The calorimeter and surrounding cylinders should also be covered by non-conducting lids, in order to prevent air-currents and evaporation of the liquid in the calorimeter. The lids are suitably cut to allow of the passage of the thermometer and stirrer.

Units.—Various units are employed in which to express the amount of heat. One of the oldest units is the amount of heat required to raise the temperature of 1 gram of water from 15° – 16° C. This quantity of heat is called the *calorie* (or *gram-calorie*), and is represented by cal. Since this unit is rather small, and since the expression of heats of reaction in this unit would lead to the use of very large numbers, the *centuple calorie*, represented by K, is frequently employed. This is the amount of heat required to raise the temperature of 1 gram of water from 0° to 100° . It is practically equal to 100 cal. A still larger unit is now frequently used, viz. the *large calorie* (abbreviated Cal.) which is equal to 1000 small or gram calories.

In many cases, especially where calculations of transformation

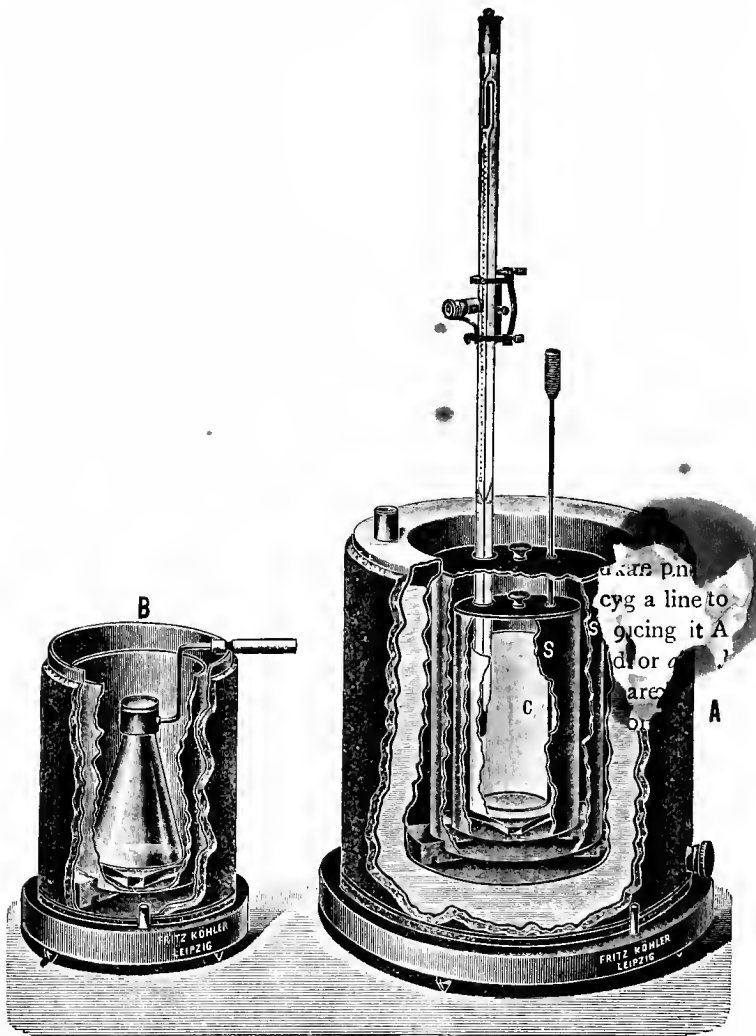

FIG. 92.

of energy are involved, it is better to employ absolute units. In this system, the unit of energy is called an *erg*, and the value of 1 cal. is 4.183×10^7 ergs. Since 1 joule is equal to 1×10^7 ergs, it follows that 1 cal. is equal to 4.183 joules; or 1 Cal. = 4.183 kilojoules (*kJ*), or $1 \text{ kJ} = 0.2391 \text{ Cal.}$

A.—HEAT OF NEUTRALIZATION OF ACIDS AND BASES IN DILUTE SOLUTION

According to the theory of electrolytic dissociation, the molecules of acids, bases, and salts in aqueous solution, are regarded as undergoing ionization to a greater or less extent. If this ionization were complete, then the process of neutralization, say of hydrochloric acid by caustic soda, could be represented by the equation, $\text{H}^+ + \text{Cl}^- + \text{Na}^+ + \text{OH}^- = \text{Na}^+ + \text{Cl}^- + \text{H}_2\text{O}$. That is to say, the process would consist merely in the combination of hydrion and hydroxidion to form (practically) water. This may be regarded as sufficiently near to the case of strong acids and bases in fairly dilute solution, and consequently, in such cases, the heat of neutralization will be the same for all acids and bases, viz. 13.7 Cal. In the case of weak acids or weak bases, however, ionization may be far from complete, so that, on neutralization, the heat effect will involve not only the heat of combination of hydrion and hydroxidion, but also the heat of ionization of the weak acid or base. The heat of neutralization in such cases will, therefore, be either greater or less than 13.7 Cal., according as ionization of the base or acid is accompanied by an evolution or absorption of heat.

In illustration of what has been said, the following experiments should be performed.

EXPERIMENT.—*Determine the Heat of Neutralization of Hydrochloric Acid by Sodium Hydroxide.*

Prepare approximately fourth-normal solutions of hydrochloric acid and of sodium hydroxide, free from carbonate (see p. 197), and determine their strength by titration.

Fit together the calorimeter and its protecting vessels (all well polished), as shown in Fig. 92, the outer vessel having been filled with water some hours previously in order that it may acquire, as nearly as possible, the temperature of the room. A Beckmann thermometer, previously set (p. 130) so that the mercury stands at the lower end of the scale at the temperature of the room, is passed through the holes in the covers of the calorimeter and supported so that the bulb passes about two-thirds down the calorimeter. The calorimeter is also furnished either with a simple ring stirrer to be worked by the hand, or, preferably, with a rotating screw stirrer to be worked by a small hot-air engine or electric motor. In the latter case the rotation should be as uniform as possible, and not too rapid.

In the calorimeter are placed 250 c.c. of the solution of caustic soda, while 250 c.c. of the hydrochloric acid are placed in a flask surrounded by several polished metal cylinders to minimize changes of temperature by radiation (Fig. 93). A Beckmann thermometer is also supported in the acid solution.¹ The readings on this thermometer must be compared with those on the thermometer placed in the alkali, in order that it may be known whether the temperature of the acid and alkali is the same at the time of mixing; or, if not, what the difference of temperature is.

¹ When the acid is afterwards poured into the alkali, a certain amount of it will, of course, remain adhering to the walls of the flask and to the thermometer. This amount can be determined by titration; but the necessity for this can be avoided by first wetting the flask and thermometer with the acid solution, and then pouring in 250 c.c. of the acid solution. In this way practically the same amount of acid will be introduced into the flask at the beginning as is left after the acid has been poured into the alkali.

Since either before or after the addition of the acid to the alkali the temperature of the liquid in the calorimeter must be different from atmospheric temperature, it follows that there will be an interchange of heat between the calorimeter and the outside. As this can introduce a not inconsiderable error into the measurement, allowance for the heat lost or gained by radiation must be made. One way in which the error can be minimized is to arrange that the acid and alkali, before mixing, are at a temperature as much below that of the room as the mixture will be above room temperature. The amount of heat gained from the outside will then be approximately the same as that lost by radiation from the calorimeter.

A better method, however, is the following: The temperatures registered by the thermometers immersed in the acid and alkali should be read, say every minute, for at least five minutes before the mixing of the solutions takes place. During this time the solutions should be stirred quietly. Then, at a particular moment, which must be noted, the acid is poured as rapidly as possible into the alkali, the two solutions mixed well, and the temperature of the mixture read every half-minute every minute for five or ten minutes after mixing took place, until it is found that the fall of temperature becomes uniform. At first the temperature rises rapidly, then more slowly, and then begins to fall. Since, as the temperature rises above that of the room, radiation from the calorimeter is taking place, it follows that the highest temperature read will be lower than if no loss of heat by the calorimeter occurred. In order, therefore, to get the true elevation of temperature produced by the heat of neutralization, the temperatures read on the thermometer before and after mixing should be plotted on squared paper, the thermometer readings being represented as ordinates and the time as abscissæ. In this way two figures similar to those shown in Fig. 93 will be obtained.

In this figure the temperature of acid and alkali is represented

as rising slowly previous to mixing: but the reverse may, of course, also be found. If the time of mixing was, say, at the

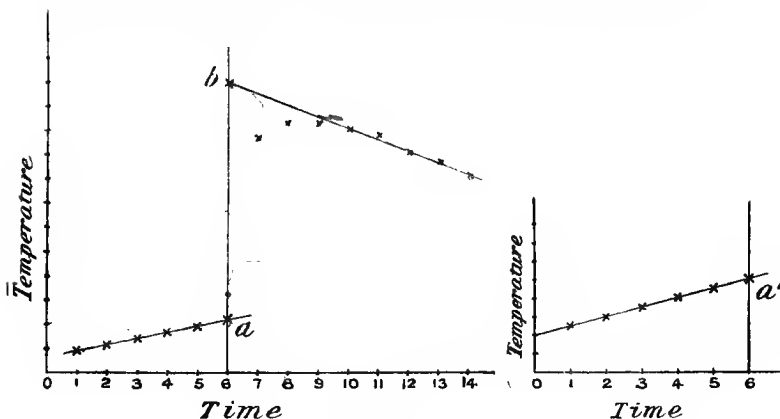

FIG. 93.

sixth minute, the temperature (t_1 or t_1') which the alkali and acid would have at that moment is obtained by drawing a line through the different temperature readings and producing it to cut the perpendicular at the sixth minute (point a or a'); and the highest temperature (t_2) which would have been reached in the absence of radiation is obtained by drawing a straight line through the last readings (when the fall of temperature has become uniform), and producing this line back so as to cut the perpendicular at the sixth minute. This gives the point b . The distance ab then gives the elevation of temperature required ($t_2 - t_1$).

Calculation of the Heat of Neutralization.—As is shown in text-books on Physics, the heat produced in the reaction must be equal to the heat required to raise the solution, the calorimeter, the thermometer, and the stirrer through the range of temperature $t_2 - t_1$ degrees. This, however, is equal

to the sum of the masses of the different parts multiplied by their specific heat. We therefore obtain for the heat evolved on mixing the acid and alkali—

$$\text{heat evolved} = (m_1s_1 + m_2s_2 + m_3s_3 + m_4s_4)(t_2 - t_1)$$

where m_1, m_2, m_3, m_4 are the masses of the solution, calorimeter, thermometer, and stirrer respectively, and s_1, s_2, s_3, s_4 their specific heats. The following table gives the specific heat of the usual metals employed for calorimeter or stirrer :—

Platinum	0·032
Silver	0·056
Brass	0·092
Nickel	0·109

As regards the specific heat of the solution, this will vary more or less from that of pure water according to the concentration of the dissolved salt. With solutions of the strength used above, it will be sufficiently accurate for our present purpose to take the water-equivalent of the solution (*i.e.* its mass multiplied by its specific heat), as being equal to that of the *water* contained in it.

In the case of the thermometer, which consists of glass and mercury, the weight of which cannot be determined separately, the water-equivalent is obtained by making use of the fact that the specific heat of equal *volumes* of glass and mercury is practically the same and equal to 0·47 per cubic centimetre. To obtain the volume, a beaker of water is counterpoised on the balance, and the thermometer then supported on a stand so that the bulb is immersed in the water. The weight which has now to be added in order to obtain equipoise gives the volume of the bulb. In the case of the Beckmann thermometer, the stem above the bulb is not solid, so that the external volume does not represent the volume of the glass and mercury. The external volume of

the stem, so far as it was immersed in the solution during the experiment, should be determined separately from that of the bulb, and about one-fifth of the volume so obtained taken as the volume of the glass and mercury.

Considering that the acid and alkali are not completely ionized, and that the specific heat of the solution is only approximately estimated, the result of the measurement carried out in the manner described, may deviate from the value 13.7 Cal. by about 0.2 Cal.

Further Experiments.—In the manner described above, one should also determine the heat of neutralization of a weak base (ammonium hydroxide) with a strong acid (hydrochloric acid), and of a strong base (sodium hydroxide) with a weak acid (acetic acid). Determine also the heat of neutralization of phosphoric acid using 1, 2, and 3 moles of sodium hydroxide per mole of phosphoric acid.

PROBLEMS

1. From the heat of neutralization of ammonium hydroxide by hydrochloric acid, and of sodium hydroxide by acetic acid, combined with the value obtained for the heat of neutralization of sodium hydroxide by hydrochloric acid, calculate the heat of ionization of ammonium hydroxide and of acetic acid. It may be assumed that in the dilutions employed, these substances were completely unionized.

2. Find what percentage error will be introduced into the result of the preceding calculation, if there was an error of ± 1 per cent. in the determination of the heats of neutralization.

B.—HEAT OF SOLUTION

The heat of solution of a solid or liquid substance can be determined in practically the same manner as that employed

for the determination of the heat of neutralization, and the same apparatus can be employed. Since the heat which is evolved or absorbed on dissolving a substance depends on the amount of water or other solvent employed, the statement of the heat of solution has a definite meaning only when the concentration of the solution formed is given. If the dilution is so great that further dilution is unaccompanied by any heat effect, then the heat measured per gram molecule of solute is known as the heat of solution at infinite dilution. Usually, however, it will not be possible to determine this heat of solution directly, and one must therefore state the number of moles of water in which one mole of solute is dissolved.

EXPERIMENT.—*Determine the Heat of Solution of Potassium Nitrate.*

A quantity of the salt, about 15 grms., is finely powdered and placed in a test-tube. The latter is weighed, and then placed in a beaker of water surrounded by the protecting cylinders (Fig. 92, B), and the temperature of the water noted. In the calorimeter are placed about 500 gms. of distilled water, and the apparatus then fitted together with thermometer and stirrer as described on p. 279. The same precautions as before as regards temperature readings are taken.

When the salt has taken the temperature of the water (say after 10 to 15 minutes), the tube is removed, roughly dried, and the contents emptied into the water in the calorimeter. Since the accuracy of the determination depends to a considerable extent on the rapidity with which the solid dissolves, it is of importance that the salt should have been finely powdered, and that the stirring should be fairly vigorous. In this case a motor-driven stirrer is preferable to a hand-stirrer. The weight of salt taken is determined by weighing the tube before and after the addition of salt to the water.

In the above method, it may of course happen that the salt has not the same temperature as the water, so that a

knowledge of the specific heat would be necessary. When this is known, then the heat given to or taken from the solvent by the salt, owing to the difference of temperature, can be easily calculated; but even where the specific heat of the solid is not known, no great error will, in most cases, be made, unless the temperature difference between the solid and the solvent is considerable. By alteration of the temperature of the water in which the tube of salt is immersed, it will not be difficult to arrange that the difference of temperature between the solid and the solvent is very small.

In determining the heat of solution of salts, attention must be paid to whether they are anhydrous or hydrated; and in the latter case, to the degree of hydration. Different values for the heat of solution will be obtained according to the state of the solid as regards these factors.

For the sake of comparison, the heat of solution of some of the commoner salts is given in the following table:—

Salt.	Number of moles of water to 1 mole of salt.	Heat of solution, Cal.
KCl	200	- 4.4
KNO ₃	200	- 8.5
ZnSO ₄	400	+ 18.5
ZnSO ₄ .7H ₂ O	400	- 4.24
CuSO ₄	300	+ 15.8
CuSO ₄ .5H ₂ O	300	- 2.7

C.—HEAT OF COMBUSTION

By the heat of combustion of a substance is meant the amount of heat evolved in the combustion of 1 gram-molecule of the substance. If m be the mass of substance burned, the molecular weight of which is M ; and if W and w represent the weight of water and the water-equivalent of the apparatus

respectively; and if $(T' - T)$ represents the rise of temperature produced by the combustion; then the heat of combustion is given by—

$$Q = \frac{M}{m}(W + w)(T' - T) \text{ calories}$$

The heat of combustion is best determined by the method due to Berthelot, which consists in burning the substance in an atmosphere of compressed oxygen. The original design of the autoclave in which the combustion takes place (the Berthelot bomb) has been modified in various ways; and the form to be described here is the modification due to Mahler and to Kroeker.

The Bomb.—The bomb consists of a steel vessel, the

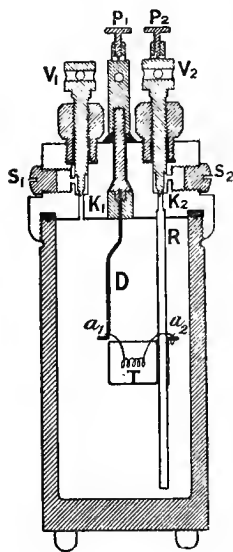

FIG. 94.

interior of which is enamelled, and is fitted with a lid lined on the under surface with platinum foil (Fig. 94). To ensure an air-tight junction, the lid is screwed firmly down on a lead washer. The lid is pierced by two channels— K_2 , through which the bomb is filled with oxygen, and K_1 , through which the gaseous products of combustion can be allowed to escape. Both these channels can be closed by means of the screw spindles V_2 and V_1 . The continuation of the channel K_2 is formed by the platinum tube R , to which a platinum crucible, T , is attached for receiving the substance to be burned. The ignition of the substance is effected by means of a piece of iron wire, which is caused to burn by means of an electric current. This wire is attached to

the small pin a_2 on the tube R , and to the wire D . The

current is led from a battery to these two poles, by wires clamped in the terminals P_1 and P_2 . The screws S_1 and S_2

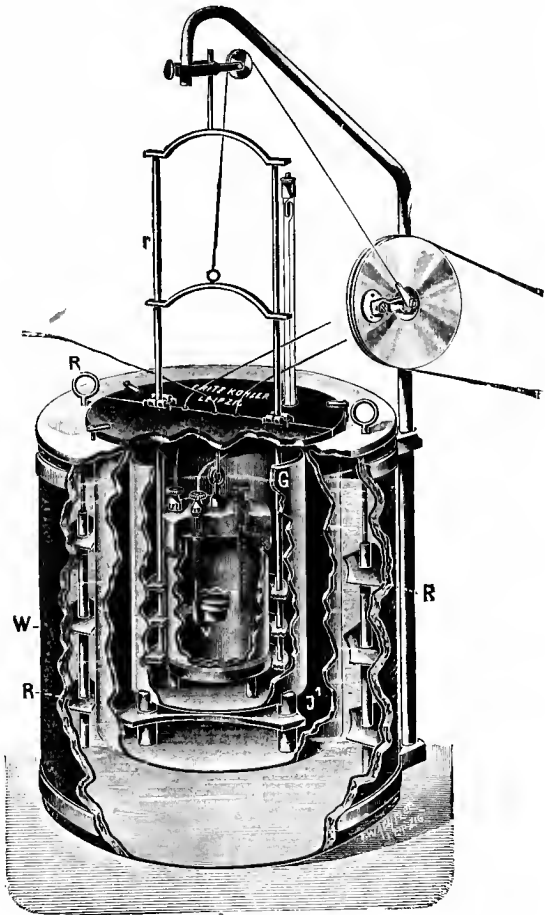

FIG. 95.

serve merely to close the lateral channels while the bomb is immersed in the water of the calorimeter.

The Calorimeter.—The heat of combustion is measured by the elevation of temperature produced in a given weight of water in a calorimeter. The calorimeter used for this purpose is essentially the same as that previously described (p. 276). It consists (Fig. 95) of a large nickel-plated metal vessel, G, containing the water in which the bomb is immersed, and of a water-mantle, W. The water in the jacket can be stirred by means of the stirrers R R, and the water of the calorimeter by the stirrer *r*, which can be worked by hand, or driven by a motor or hot-air engine. The stroke of the stirrer should be so arranged that at its lowest point it almost touches the bottom of the calorimeter, and at its highest point rises almost to, but not above, the surface of the water.

The rise of temperature is determined by means of a Beckmann thermometer, graduated in hundredths of a degree. As it would be a matter of great inconvenience to determine the water-equivalent of the thermometer, stirrer, etc., separately, it is best to determine the water-equivalent of the whole apparatus subject to change of temperature, by finding the elevation of temperature produced on burning a weighed quantity of a substance the heat of combustion of which is known. For this purpose one of the following substances may be used:—

Substance.	Approximate amount to be taken.	Heat of combustion per 1 gm.
Benzoic acid	0.8–1.0 gm.	6322 cal.
Camphor	0.5–0.7 „	9292 „
Naphthalene	0.5–0.7 „	9693 „
Hippuric acid	0.8–1.0 „	5668 „

Making a Determination.—The substance to be burned is first compressed into a tabloid by means of a press (p. 132),

and, after being weighed, is placed in the platinum crucible T. A piece of fine iron wire, about one-tenth of a millimetre in diameter and 6-7 cm. in length, is weighed, and its ends twisted round the wire D and the pin a_2 . The middle portion of the wire should be formed into a narrow spiral by twisting it round a pin. When the wire is attached, raise the crucible until the middle portion of the iron ignition wire touches the rod of compressed substance. After having coated the lead washer and the screw on the bomb with vaseline, the cover is tightly screwed down with the help of a large spanner, the bomb being meanwhile fixed in its holder. Be very careful that no grit gets either on the lead washer or in the screw of the bomb. The latter is now ready to be filled with oxygen.

Connect a cylinder of compressed oxygen with a manometer, and the latter, after removing the screw S_2 , with the lateral channel of the bomb leading to the valve K_2 . Open the valves V_2 and V_1 and allow oxygen to stream through the bomb for a short time. Then close the valve V_1 and continue passing oxygen into the bomb until the pressure registered on the manometer is 20-25 atmospheres. Now close the valve K_2 , disconnect the tube from the manometer, and replace S_2 . If there is any leakage of gas, it will generally make itself known by a slight hissing sound.

The calorimeter may now be got ready. The water-mantle having been filled with water (preferably some hours previously), a thermometer is hung in the air-space inside. After it has taken the temperature of the enclosure, the temperature is read. A Beckmann thermometer is now set (p. 130) so that the lower end of the scale represents a temperature of about 1.5-2 degrees *below* that found in the enclosure of the water-mantle.

The calorimeter vessel is then tared, a quantity of water placed in it, and the weight of the water determined on a balance accurate to about 1 gm. The amount of water used should be such that when the bomb is immersed, the water

rises up to the level of the screws S_1, S_2 . This must have been determined beforehand.

In order to reduce the error due to radiation, the temperature of the water in the calorimeter should be such that, before the combustion in the bomb occurs, it is about as much below the surrounding temperature (temperature of the air-space) as it will be above it, after the combustion has taken place. As the rise of temperature should be about 2.5° to 3° , the temperature of the water should be made about 1.5° lower than that of its surroundings.

The charged bomb is now lowered into the water of the calorimeter, with the help of a stout cord passed through the hole in the middle pillar on the cover of the bomb. The wires from a battery ¹ are then connected with the screws P_1, P_2 , and the lid of the calorimeter placed in position. Insert the Beckmann thermometer through the cover of the calorimeter and set the stirrer in motion, at such a rate that it rises and falls about once per second. After the bomb has been in the water about five minutes, commence reading the temperature on the Beckmann thermometer, readings being made every minute for about ten minutes. At the tenth minute close the electric circuit by means of a switch key. The iron wire will thereby be caused to burn and will ignite the substance in the crucible. The temperature of the water in the calorimeter will now begin to rise rapidly. Again take readings of the temperature, minute by minute (it will probably be impossible to make a reading at the first minute after ignition), until the highest temperature is reached, a point which must be carefully noted. The temperature will now begin to fall slowly, and readings at intervals of a minute must again be made for about ten minutes.

¹ The potential employed must be such as to cause the iron wire to take fire in the course of one or two seconds. This must be ascertained by a separate experiment.

This completes the series of observations. The bomb is removed from the calorimeter and carefully dried. Screw S_1 is removed, and the valve K_1 slowly opened so as to allow the gases to escape from the bomb. When the pressure has fallen again to that of the atmosphere, the cover is removed and the interior of the bomb cleaned and dried. Any of the iron wire which has not been oxidized should be detached and weighed, and the weight subtracted from that originally taken.

The water-equivalent of the bomb, stirrer, thermometer, and calorimeter can now be calculated, as shown in the following example:—

Weight of benzoic acid taken	= 0·8523 gm.	
Weight of iron wire	= 0·0252 „	
Heat evolved by the combustion of the benzoic acid	} = 0·8523 × 6322 = 5388·2 cal.	
Heat evolved by the combustion of the iron wire	} = 0·0252 × 1600 = 40·3 „	
Total heat evolved	= <u>5428·5</u> „	
Rise of temperature produced	= 2·3425°	
Weight of water which would have been raised by 5428·5 cal.	} = 2317·4 gm.	
Weight of water taken	= <u>2000·0</u> „	
Water equivalent of bomb, etc.	= <u>317·4</u> „	

Correction of Temperature for Radiation.—The difference of temperature between that at the moment of ignition and the highest temperature observed must be corrected for radiation. For this purpose fairly accurate results can be obtained by the graphical method described on p. 280. Another method is the following. The average rate of change of temperature (ΔT) during the period preceding the combustion is determined, and likewise during the period after the highest temperature has been read ($\Delta T'$). If n is the number of minutes which have elapsed from the moment of ignition

to the time at which the highest temperature is read, then the correction to be applied to the approximate elevation of temperature is given by—

$$C = n \cdot \Delta T' + \frac{\Delta T + \Delta T'}{2}$$

In the above expression ΔT or $\Delta T'$ is taken with + sign when the temperature is falling, and with - sign when the temperature is rising. All temperature readings are supposed to be made at intervals of one minute. For example—

I.

Number of minutes from first reading.	Temperature.	ΔT
0	1·577°	—
1	1·581°	- 0·004
2	1·583°	0·002
3	1·586°	0·003
4	1·589°	0·003
5	1·591°	0·002
6	1·594°	0·003
7	1·597°	0·003
8 (contact made)	1·599°	0·002
Mean . .		- 0·0027

II.

Number of minutes from first reading.	Temperature.
8 (contact made)	1·599°
9	—
10	3·70°
11	3·810°
12	3·925°
13	3·930°
14	3·935°

III.

Number of minutes from first reading.	Temperature.	$\Delta T'$
14	3'935°	—
15	3'935°	+ 0'000
16	3'936°	0'001
17	3'935°	0'001
18	3'935°	0'000
19	3'934°	0'001
20	3'933°	0'001
21	3'930°	0'002
22	3'928°	0'002
23	3'925°	0'003
Mean . . .		+ 0'0012

Approximate elevation of temperature } = 3'935 - 1'599 = 2'336°

$$C = 6 \times 0'0012 + \left(\frac{-0'0027 + 0'0012}{2} \right)$$

$$= 0'0072 - 0'0007 = +0'0065$$

True rise of temperature = 2'336 + 0'0065 = 2'3425°

Having determined the water-equivalent of the apparatus, the heat of combustion of a substance (say, camphor or naphthalene) can be determined. The determination is carried out exactly in the manner described above.

References.—Richards, *J. Amer. Chem. Soc.*, 1910, 32, 431; Benedict and Higgins, *ibid.*, 1910, 32, 461.

CHAPTER XIV

DETERMINATION OF SOLUBILITY

THE property of forming solutions or homogeneous mixtures of varying composition, is a very important one, and is met with in all three physical states of matter, gaseous, liquid, solid. Of the different possible kinds of solutions, the most important are those formed by the solution of a gas in a liquid, of a liquid in a liquid, and of a solid in a liquid.

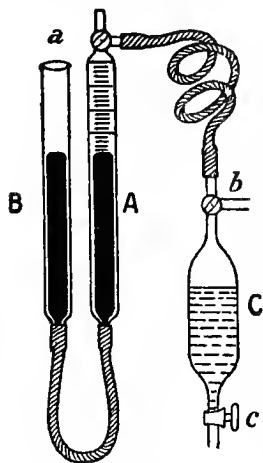

FIG. 96.

SOLUBILITY OF A GAS IN A LIQUID

The solubility of a gas in a liquid can readily be determined by means of the apparatus shown in Fig. 96, except in those cases where the gas is very soluble (ammonia, hydrogen chloride, etc). In its essential parts, the apparatus consists of a gas measuring burette A, connected with a levelling tube B. The burette is furnished with a three-way tap *a* which connects, on the one side, with the gas supply, and on the other, with a tube leading to the "absorption pipette" C, also furnished with the three-way tap *b* and an ordinary

tap *c*. Care should be taken in selecting these taps to see

that they fit closely. The gas burette and absorption pipette are connected by a length of lead or, preferably, of copper tubing of narrow bore (about 1 mm.). This tubing is best wound into a spiral, so as to give flexibility to the apparatus, and allow of the absorption pipette being shaken.

For the purpose of joining the glass and metal tubes, the following device can be employed. To the metal tube is soldered a piece of brass tubing about 2 inches long, and sufficiently wide to take the glass tube (Fig. 97). A quantity of sealing wax or hard pitch is melted inside the brass tube and the glass tube then inserted, so that the end of the metal capillary passes inside the glass tube. If necessary, the joint can be further strengthened by an external coating of sealing wax.

Before carrying out a determination, the volume of the absorption pipette between the two taps must first be determined by means of water or mercury. For the solubility of gases such as carbon dioxide, the pipette may suitably have a volume of about 100 c.c. For less soluble gases, the volume should be greater.

The solvent to be used for the absorption of the gas must first be rendered air-free. This is best done by boiling the liquid for some time in a flask with reflux condenser attached. The flask is best fitted up as shown in Fig. 98. The side tube, *a*, of the round-bottomed distilling flask is connected with a condenser by means of a piece of rubber tubing having a screw clip, *c*. Through a rubber stopper in the neck of the flask passes a glass tube, *b*, which reaches nearly to the bottom of the flask. The other end of the tube is closed by rubber tubing and a clip.

While the liquid is being boiled, the clip on the tube *b* is



FIG. 97.

closed, while there is free connection with the condenser. After the liquid has been boiled sufficiently long (10-15 mins.) the clip *c* is closed and the flame at the same time removed. After the liquid has cooled down to the ordinary temperature the flask is inverted and connected, by means of the side tube, with the lower outlet tube of the absorption pipette. The absorption pipette is exhausted by means of a pump attached to the tube *b* of the absorption pipette and the taps then closed. The clip on the tube *b* of the distillation flask is now

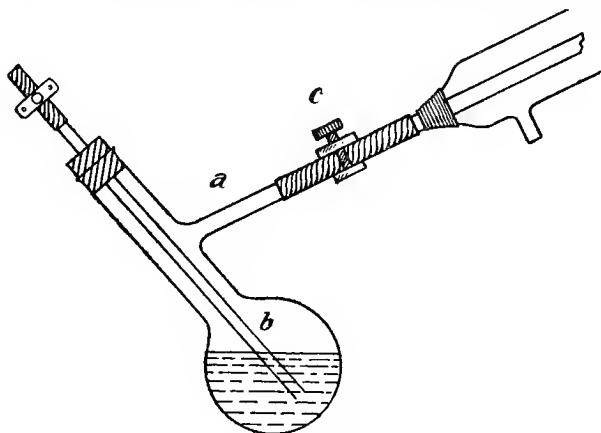

FIG. 98.

opened in order to bring the interior of the flask to atmospheric pressure, and then, *as soon as possible*, the clip *c* is opened and also the lower tap of the absorption pipette. The solvent is then drawn into the pipette from the bottom of the liquid in the boiling flask, to which the air admitted into the flask will not have had time to diffuse.

EXPERIMENT.—*Determine the Solubility of Carbon Dioxide in Water at 25°.*

The apparatus having been fitted together, the absorption pipette, filled with air-free water, is placed in a thermostat at 25°. The mercury in the measuring burette is raised until it completely fills the burette, and a current of moist carbon dioxide from a Kipp apparatus is allowed to pass through the metal connecting tube and to escape into the air through the three-way tap on the absorption pipette. When all the air has been swept out, the tap *a* is turned and the burette filled with carbon dioxide. After adjusting the levels of the mercury, the volume is read off. A slight increase of pressure is now established in the burette and the tap *a* turned so as to make connection between the burette and the pipette. The tap *c* of the pipette is opened and then the tap *b*, and a certain amount (say 20–30 c.c.) of water allowed to run out into a flask. The weight of water run out is then determined. The volume of the water in the pipette and also the air-space, can thus be calculated, since the total volume of the pipette is known.

The pipette is replaced in the thermostat and is shaken carefully from time to time, the gas in the burette being always in communication with the pipette. As absorption of the gas proceeds, the levelling tube of the burette is raised so as always to maintain the gas at atmospheric pressure. When the absorption of gas ceases, the volume left in the burette is read off.

If we define the solubility of a gas in a liquid by the ratio of the volume of gas absorbed to that of the absorbing liquid, we obtain—

$$S = \frac{v_1 \left(\frac{P_1 - p_1}{P_2 - p_2} \cdot \frac{T_3}{T_1} \right) - v_2 \left(\frac{P_2 - p_1}{P_2 - p_2} \cdot \frac{T_3}{T_2} \right) - V_1}{V_2}$$

where v_1 is the initial and v_2 the final volume of gas in the burette; P_1 is the initial and P_2 the final barometric pressure;

p_1 is the partial pressure of the water vapour at the initial absolute temperature of the burette and p_2 the partial pressure at the temperature of the thermostat; T_1 is the initial and T_2 the final absolute temperature of the burette, and T_3 the absolute temperature of the thermostat; V_1 is the volume of the gas space and V_2 the volume of the liquid in the pipette.

Instead of filling the burette with moist gas, it is better first to dry the gas by means of phosphorus pentoxide. When dry gas is employed in the burette, a short tube of phosphorus pentoxide should be inserted between the metal connecting tube and the absorption pipette. Also, the three-way tap of the absorption pipette should be kept closed except just when it is necessary to allow gas to pass from the burette to the pipette. Under these conditions, the solubility is given by the expression

$$S = \frac{\left[(v_1 - v_2) \frac{P}{P - p_2} \cdot \frac{T_3}{T_1} \right] - V_1}{V_2}$$

The barometric pressure is supposed not to change during the experiment.

The solubility of carbon dioxide in water at 25° is equal to 0.82.

SOLUBILITY OF A LIQUID IN A LIQUID

When ether is shaken with water, a certain definite amount of the ether dissolves in the water, and similarly a definite amount of water dissolves in the ether. One thus obtains two liquid solutions the composition of which depends on the temperature. At each temperature, therefore, we shall have two solubility values, one representing the solubility of ether in water, and the other the solubility of water in ether.

When the liquids are such that the amount of one of them

can conveniently be determined by analysis, the mutual solubility curve is easily determined. For this purpose the two liquids are shaken together in a stoppered bottle immersed in a thermostat. The bottle is then allowed to remain undisturbed until the two liquid layers have separated. A quantity of each layer is then pipetted out, weighed, and the amount of one of the components determined by analysis. Such a method, for example, can be employed in the case of aniline and water, the aniline being titrated by means of a solution of potassium bromate and bromide of known concentration. Similarly, also, with phenol and water.

In most cases, however, the analytical method is not applicable,¹ and it is therefore necessary to employ the synthetic method. To carry out this method, weighed amounts of the two components are placed in a small glass tube, and the end of the tube then drawn out and sealed off. So long as two liquid layers are present, a turbid liquid is formed on shaking the tube, but at the temperature at which one of the layers just disappears, this turbidity also disappears, and a single homogeneous solution is now obtained which represents a saturated solution of one of the liquids in the other. Knowing the composition of the solution (from the initial amounts taken) and the temperature at which the turbidity disappears, we obtain a point on the mutual solubility curve of the two liquids. By varying the initial amounts of the two liquids, the complete solubility curve can be obtained.

EXPERIMENT.—*Determine the Mutual Solubility Curve of Phenol and Water.*

A number of tubes are prepared about 10 cms. long and 1 cm. wide, and with a construction near the open end, as shown in Fig. 99, A. Or, in place of these, one may obtain

¹ In some cases the composition of the solution may be determined by vapour density measurements (p. 66).

tubes fitted with a stopper, which can be held in place by means of two springs, as in Fig. 99, B.

Into these tubes are introduced, by means of narrow-stemmed pipettes or funnels, different relative amounts of

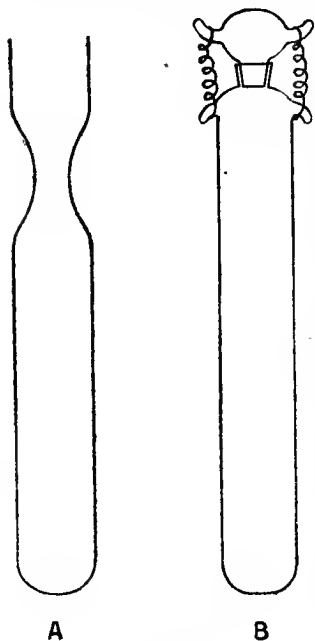

FIG. 99.

phenol and water, the weights of which are determined. The tubes are now placed in holders, formed, for example, of stout copper wire, and are immersed successively in a large beaker full of water, in which also is a thermometer graduated in tenths of a degree. The temperature of the water is caused to rise, and during this time, the tube with the two liquids is shaken at frequent intervals. At first the temperature may be allowed to rise rapidly until the turbidity shows signs of disappearing; after which the temperature must be raised only slowly, and the tube be frequently shaken. At the moment when the turbidity disappears on shaking, the temperature is read. The temperature of the

bath is now allowed to fall very slowly, and the point is noted at which the turbidity just begins to appear once more. The experiment is repeated once or twice, and the mean of the temperatures at which the turbidity disappears on heating and reappears on cooling, is taken as the temperature at which phenol and water, in the particular proportions taken, become completely miscible. In a similar manner the temperatures

are obtained for other mixtures of phenol and water. The results are then plotted with percentage amount of one component as abscissæ against temperatures at which homogeneity occurs, as ordinates, and a smooth curve is drawn through these points. The maximum temperature point on the curve is known as the *critical solution temperature*.

This critical solution temperature is very greatly influenced by the presence of impurities, and this behaviour may be employed for the purpose of detecting the presence of impurities, or, in other words, as a criterion of purity.

EXPERIMENT.—*Determine the Effect of Impurity on the Critical Solution Temperature of Phenol and Water.*

Having determined, as above, the mutual solubility curve and the critical solution temperature of pure phenol and water, similar experiments should be carried out using water and phenol to which about 0.5 to 1 per cent. of sodium chloride has been added; or the sodium chloride may be dissolved in the water. The experiments may be confined to mixtures containing from about 20–50 per cent. of phenol.

Additional Experiments may be carried out with the following pairs of liquids: iso-butyric acid and water, hexane and methyl alcohol, carbon disulphide and methyl alcohol, acetylacetone and water.

SOLUBILITY OF SOLIDS IN LIQUIDS

When a solid is brought into contact with a liquid in which it can dissolve, a certain amount of it passes into solution; and the process continues until the concentration of the solute in the solution reaches a definite value independent of the amount of solid present. A condition of equilibrium is thus established between the solid and the solution; the solution is *saturated*.

The condition of saturation, therefore, depends not only on

the solvent, but also on the solute, or the solid phase in equilibrium with the solution; so that in all determinations of the solubility it is necessary, not only to determine the amount of dissolved substance in the solution, but also to ascertain the character of the solid phase which is in equilibrium with the solution. The importance of this must ever be borne in mind.

The amount of substance dissolved depends, not only on the substance, but also on the temperature; and the solubility of a substance, or the number of grams of substance dissolved by a given weight of the solvent, may either increase or decrease with rise of temperature. In all cases, however, whatever be its particular form, the solubility curve of any substance is continuous, so long as the solid phase, or solid substance in contact with the solution, remains unchanged. If, however, a change in the solid phase occurs, the solubility curve will show a "break" or discontinuous change in direction.

For the production of the equilibrium between a solid and a liquid, *i.e.* for the production of a saturated solution, time is necessary; and the length of time required not only varies with the state of subdivision of the solid, and the efficiency of the shaking or stirring, but is also dependent on the nature of the substance. In all cases, therefore, care must be taken that sufficient time is allowed for equilibrium to be established; more especially when changes in the solid phase may occur.

Determination of the Solubility.—The production of a saturated solution is most simply carried out in the apparatus shown in Fig. 100. It consists of a tube, *a*, in which the solid and solvent are placed, and vigorously stirred by means of the glass screw stirrer shown at *b*. The stem of the latter passes through a glass tube, inserted in the rubber stopper by which the solubility tube is closed. The tube should be chosen of such a size that the stem of the stirrer just passes through, the bearing being well lubricated by means of vaseline.

The progress of solution towards saturation can be tested

by withdrawing some of the solution from time to time, and determining the amount of dissolved substance. This requires only to be done once, the solution in other experiments being then well stirred for a period somewhat longer than that required for complete saturation.

When saturation has been effected, the solution must be analyzed. The stirrer is removed from the tube, and the latter closed with an unbored cork, the solubility tube being meanwhile kept in the thermostat. After the solid has subsided, a quantity of the solution is transferred to a tared weighing bottle by means of a pipette, to the end of which is attached, by rubber tubing, a short glass tube filled with cotton-wool to act as a filter; and the solution is then weighed. The amount of solid in solution is determined in an appropriate manner, most simply (if allowable) by evaporation on the water-bath, and drying, if necessary, at a slightly higher temperature.

When the temperature of experiment is fairly high, it may be necessary to warm the pipette first before withdrawing the solution; otherwise solid may separate out in the pipette.

Instead of an ordinary pipette, one may also use a graduated pipette like that shown in Fig. 101. This has the advantage that it allows of the determination of the density of the solutions at the same time. The volume of the tube, up to different marks on the scale, is first determined by filling with

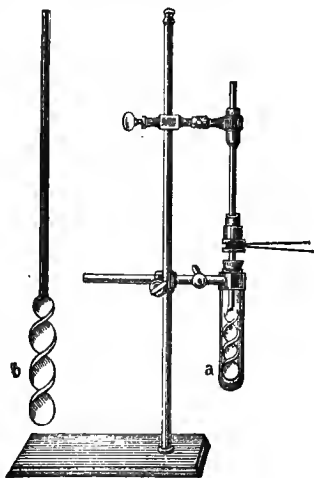

FIG. 100.

water at a known temperature, and weighing; the lower end of the pipette, below the stop-cock *d*, being dried by means of filter-paper. When used for withdrawing solution, the pipette is furnished with the filter tube *e*, filled with cotton-wool. The tube with stop-cock *f* is attached at the upper end of the pipette, solution is sucked up until the meniscus is on the scale; stop-cock *f* is then closed, the level of liquid read off, and the stop-cock *d* then closed. The tube *e* is detached, and the end of the pipette cleaned and dried. The cap *c* is placed in position, and the weight of the solution determined. The solution is then transferred to a vessel for analysis, the pipette being washed out with water. If solid has separated out in the pipette, fill the lower end of the pipette with water, stand the pipette in water, and open the stop-cock *d*, the cap *c* being kept on. The heavier solution will pass downwards, while water will pass up into the pipette and dissolve the solid.

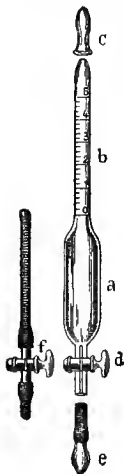

FIG. 101.

EXPERIMENT.—*Determine the Solubility of Potassium Chloride from 10° up to 50°.*

Fit up a thermostat, furnished with a Foote regulator (p. 75), and regulate the temperature so as to be at about 5°–8°, the variations of temperature being not greater than 0.1°. In the solubility tube (Fig. 100) place a quantity of *finely powdered* potassium chloride and water, and after fitting it with a stirrer, place it in the thermostat so that it is immersed up to the level of the cork. The solid and solution should now be stirred for 2–3 hours, and a quantity of the solution removed as described above, weighed, and evaporated to dryness. To the solution in the tube add a further quantity of *finely powdered* potassium chloride, and allow the stirring to continue for another period of 1–2 hours. Again determine the composition of the

solution. If this agrees with the former determination, it shows that the saturation was complete in the first period of 2-3 hours; but if the amount of dissolved solid is greater in the second case, the stirring must be continued for some time longer, with addition, if necessary, of more potassium chloride, until the concentration of the solution becomes constant. This gives the solubility at the particular temperature of the experiment, and should be controlled by a second, independent determination. Express the solubility as grams of salt to 100 grams of water.

Having determined the solubility at a temperature between 5° and 8° , raise the temperature of the thermostat by 5° or 10° , and make another determination of the solubility at this higher temperature. Make further determinations at intervals of not more than 10° , up to 50° - 55° . At the higher temperatures, the Foote regulator must be replaced by a gas thermo-regulator (p. 72). Instead of making two determinations at each temperature, as mentioned above, the first series of determinations can be controlled by approaching saturation from the side of super-saturation, *i.e.* by allowing the solution to cool down from a higher temperature *while in contact with the solid*. The solid phase must be present.

The results are then plotted in rectangular co-ordinates, the temperatures being plotted as abscissæ, and the solubility (grams of salt to 100 grams of water) as ordinates. Draw a smooth curve through the points so obtained, and from the curve read off the solubility at every five degrees.

In the case of potassium chloride, we are dealing with a substance which remains unchanged throughout the course of the experiments. We shall now take a case where the solid phase undergoes change.

EXPERIMENT.—*Determine the Solubility of Sodium Sulphate from 10° to 50° .*

The determinations of the solubility are carried out exactly

as described above. Between 28° and 35° , determinations should be made at every two degrees. The results are then plotted graphically as before, the solubility being calculated in grams of *anhydrous* salt to 100 grams of water.

At the temperature of 30° , and also at the temperature of about 35° , the excess of solid in contact with the solution should be rapidly separated by filtration with the aid of a water-pump, using for the filtration merely a loose plug of cotton-wool in the stem of the funnel. The solid is then rapidly pressed between filter-paper, and the amount of water of crystallization determined in the ordinary way.

The solubility curves obtained from the above determinations should be produced so as to cut each other. The point of intersection gives the *transition point* of

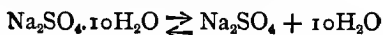

References.—For solubility of gases: Geffcken, *Zeitschr. physikal. Chem.*, 1904, **49**, 298; Findlay and Creighton, *Trans. Chem. Soc.*, 1910, **97**, 536. For solubility of liquids: Rothmund, *Zeitschr. physikal. Chem.*, 1898, **26**, 475; Timmermans, *ibid.*, 1907, **58**, 129.

CHAPTER XV

DETERMINATION OF TRANSITION POINTS

It is a well-known fact that there are many substances which are capable of existing in more than one crystalline form, one of the best-known examples of this being sulphur. In general, these different polymorphous forms, as they are called, are not equally stable at a given temperature. Thus, at the ordinary temperatures, rhombic sulphur is the most stable form, and monoclinic sulphur, if kept sufficiently long, will change spontaneously into the rhombic. If, however, we raise the temperature to, say, 100° – 110° , it is found that the monoclinic crystals can be kept indefinitely without undergoing change, while the rhombic crystals pass into monoclinic. At this temperature, therefore, the monoclinic is the most stable form. At a temperature of about 96° , however, it is found that both forms are equally stable, and that neither form changes into the other on keeping. This temperature is known as the *transition temperature*, or transition point. This point gives the temperature at which the relative stability of the polymorphous forms changes:

Not only do we find such transition points in the case of polymorphous substances, but we find them, in general, also in the case of salt hydrates. When a salt combines with water to form one or more different hydrates, it is found that under given conditions of temperature, etc., only one of the hydrates, or it may be the anhydrous salt, is stable. Thus, on heating sodium sulphate decahydrate to above 33° , it is found that decomposition occurs into anhydrous sodium sulphate, and a

•

saturated solution of this salt. On the other hand, on allowing a saturated solution of sodium sulphate to cool down in presence of anhydrous sodium sulphate, it is found that when the solution is cooled below about 33° , the anhydrous salt takes up water and forms crystals of the decahydrate. The temperature of (approximately) 33° , therefore constitutes a transition point or inversion point for the change $\text{Na}_2\text{SO}_4 \cdot 10\text{H}_2\text{O} \rightleftharpoons \text{Na}_2\text{SO}_4 + 10\text{H}_2\text{O}$. Similar relationships are, in general, found in the case of other salt hydrates.

Determination of the Transition Point.—For the determination of the transition point of a polymorphous solid or of a salt hydrate, various methods have been employed. The different methods, however, are not equally suitable in every case; nor is the value obtained by the different methods always identical. It is well, therefore, to determine the transition point by different methods. The more important of these are: solubility, thermometric, dilatometric, and tensimetric methods.

1. *Solubility Method.*—This has already been studied in the preceding chapter.

2. *Thermometric Method.*—The thermometric method depends on the fact that change from one system to another on passing through the transition point, is accompanied by a heat effect—absorption or evolution of heat.¹ Thus, when $\text{Na}_2\text{SO}_4 \cdot 10\text{H}_2\text{O}$ breaks up into Na_2SO_4 and solution, heat is absorbed; while the reverse change is accompanied by evolution of heat.

EXPERIMENT.—*Determine the Transition Point of Glauber's Salt by the Thermometric Method.*

A moderately large quantity (30 to 50 grms.) of recrystallized sodium sulphate decahydrate is placed in a thin glass tube, so

¹ This method is not in general suitable for the determination of the transition point of polymorphic forms, on account of the slowness of change and consequent slight evolution of heat in unit of time.

as entirely to surround the bulb of a thermometer, graduated in tenths of a degree. The tube is placed in a large beaker of water, the temperature of which can be very slowly raised by means of a small flame, and be kept uniform by means of a stirrer. The temperature of the bath is raised to about 32° , at which it may be kept for several minutes, and then very gradually raised until the Glauber's salt becomes partially liquid. The temperature of the bath is then kept constant. The partially liquefied mass in the tube is now well stirred by means of a ring stirrer of glass or platinum, as in carrying out a freezing-point determination with the Beckmann apparatus (p. 134), and the temperature of the mass read off from time to time. Meanwhile the temperature of the bath may be allowed to rise very slowly (1° in 5 minutes), and the temperature of the partially liquefied mass should be read off every minute. After the temperature of the bath and of the partially liquefied mass has risen to about 34° , allow the temperature to fall slowly. Meanwhile stir the sodium sulphate and solution well, and read the temperature every minute.

The temperature readings for the mixture in the tube are plotted against the time, and in this way two curves will be obtained, one for rising and the other for falling temperature, each showing an approximately perpendicular portion. Owing to suspended transformation, these two perpendicular portions may not coincide.

Repeat the experiment, but allow the temperature of the bath to rise more slowly between 32° and 33° . Again read the temperature on the thermometer in the tube every minute, and plot the results as before.

Similar determinations may also be carried out with the salts given in Table I. of the Appendix.

3. *Dilatometric Method.*—Since, in the majority of cases, transformation at the transition point is accompanied by an appreciable change of volume, it is only necessary to ascertain

the temperature at which this change of volume occurs in order to determine the transition point. For this purpose the *dilatometer* is employed, an apparatus which consists of a bulb with capillary tube attached, and which constitutes a sort of large thermometer (Fig. 102). Some of the substance to be examined is passed into the bulb A through the tube B, which is then sealed off. The rest of the bulb and a small portion of the capillary tube are then filled with some liquid, which is without chemical action on the substance under investigation. A liquid, however, may be employed which dissolves the substance slightly.

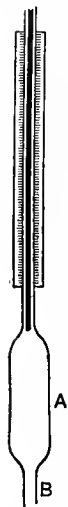

FIG. 102.

In using the dilatometer, two methods of procedure may be followed. According to the first method, the dilatometer containing the form stable at lower temperatures is placed in a thermostat, maintained at a constant temperature, until it has taken the temperature of the bath. The height of the meniscus is then read on a millimetre scale attached to the capillary. The temperature of the thermostat is then slowly raised, and the height of the meniscus at each degree of temperature noted. If no change takes place in the solid, the expansion will be practically uniform, or the rise in the level of the meniscus per degree of temperature will be practically the same at the different temperatures, as represented by the line AB in Fig. 103. On passing through the transition point, however, there will be a more or less sudden increase in the rise of the meniscus per degree of temperature (line BC), if the change in the system is accompanied by increase of volume. Thereafter, the expansion will again become uniform (CD). Similarly, on cooling, contraction will at first be uniform, and then at the transition point there will be a relatively large diminution of volume (DE, EF).

If the transformation occurred immediately the transition point was reached, the sudden expansion and contraction would

take place at the same temperature. There is, however, always a certain lag, so that, with rising temperature, the relatively large expansion does not take place until a temperature somewhat higher than the transition point; and with falling temperature, the contraction occurs at a temperature somewhat below the transition point (*e.g.* BC and EF). The amount of lag will vary from case to case, and will depend on the rapidity with which the temperature is raised

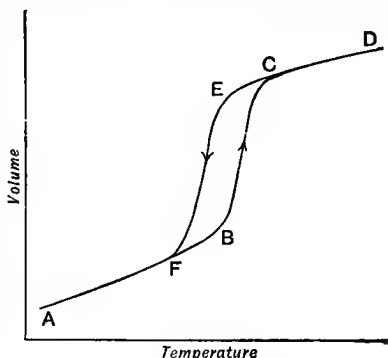

FIG. 103.

and the velocity with which the system changes. After the transition point has been ascertained approximately in this way, the determination is made with greater care, by allowing the temperature in the neighbourhood of the transition point to alter more slowly. In this way the amount of lag is diminished.

Another method of using the dilatometer depends on the fact that while above or below the transition point transformation of one form into the other can take place, at the transition point the two forms undergo no change. The bulb of the dilatometer is charged, therefore, with a mixture of the stable and unstable forms and a suitable measuring liquid, and is then immersed in a bath at constant temperature. After the temperature of the bath has been acquired, readings of the height of the meniscus are made from time to time to ascertain whether expansion or contraction occurs. If expansion is found, the temperature of the thermostat is altered until a point is reached at which a gradual contraction takes place. The transition point must then lie between these two temperatures;

and by repeating the determinations it will be possible to reduce the difference between the temperatures at which expansion and contraction take place, to, say, 1° , and to fix the temperature of the transition point, therefore, to within half a degree.¹

EXPERIMENT.—*Determine the Transition Point for Glauber's Salt and Anhydrous Sodium Sulphate.*

Invert the dilatometer (Fig. 102), and drop into the bulb a small glass bead with stalk, so as to close the end of the capillary tube, and so prevent it being blocked by solid material. Then introduce a quantity of powdered Glauber's salt until the bulb is half or three-quarters full, and seal the end of the tube B. The dilatometer must now be filled with some measuring liquid, *e.g.* petroleum or xylene. This is best done by attaching an adapter to the end of the capillary tube by means of a rubber stopper, as shown in Fig. 104. A quantity of petroleum is introduced into the wider portion of this tube, and the dilatometer then exhausted by means of a water-pump. On now allowing air to enter at *a*, petroleum is driven down into the bulb. The operation is repeated until all the air is withdrawn from the dilatometer and replaced by petroleum. Tap the tube so as to loosen any adhering air-bubbles. The excess of petroleum is then removed from the capillary by means of a long, finely-drawn capillary tube, so that when the dilatometer is placed in the thermostat, the petroleum meniscus may remain on the scale.

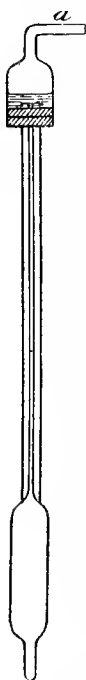

FIG. 104.

Immerse the bulb of the dilatometer completely in the water of a thermostat, the initial temperature of which may be 25° to 26° . After about five or ten minutes, read the level of the petroleum, and then slowly raise the temperature, 1° in five to ten minutes, and at each degree

¹ These experiments generally require a considerable period of time.

again read the level of the meniscus in the capillary. At 32° to 33° , it should be found that the rise of the meniscus per degree of temperature is relatively very large; and that as the temperature is raised above 33° , the rise per degree becomes less again and nearly uniform. This shows that the transition point is between 32° and 33° . Carry out the same series of observations in the reverse order, allowing the temperature to fall from about 35° or 36° to about 28° . Then make a more exact determination by allowing the temperature to alter very slowly from 31° to 34° .

EXPERIMENT.—*Determine the Temperature of Formation of Astracanite from the Simple Salts.*

When a mixture of sodium and magnesium sulphates is warmed to about 21° , partial liquefaction occurs, and astracanite separates out, as represented by the equation—

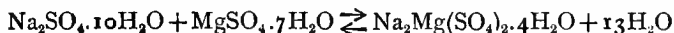

Similarly, on cooling astracanite plus water, formation of $\text{Na}_2\text{SO}_4 \cdot 10\text{H}_2\text{O}$ and $\text{MgSO}_4 \cdot 7\text{H}_2\text{O}$ occurs on passing 21° . This transition point can also be determined by means of the dilatometer.

The experiment is carried out as described under the preceding experiment, the dilatometer being charged with a mixture of Glauber's salt and magnesium sulphate in nearly equimolecular proportions. The initial temperature of the thermostat may be taken at 15° to 16° .

4. *Tensimetric Method.*—When the systems undergoing change at the transition point possess a measurable vapour pressure, measurements of the latter may be used to determine the transition point. This depends on the fact that at the transition point the vapour pressure of the two systems becomes equal.

For the purpose of these measurements, a differential manometer is employed, the usual form being that known as

the Bremer-Frowein tensimeter (Fig. 105). This consists of a U-tube, the limbs of which are bent close together, and placed in front of a millimetre scale. The bend of the tube is filled with some suitable liquid, e.g. bromonaphthalene. The substances the vapour pressures of which are to be compared, are placed in the small flasks *d* and *e*, the necks of which are then sealed off. The apparatus is then placed in an inclined position so as to allow the measuring liquid to flow from the bend of the tube into the bulbs *a* and *b*. The tube *f* is connected with a mercury pump (or Fleuss pump), and the apparatus exhausted. The tube *f* is then sealed off. The apparatus is now placed in a perpendicular position in a thermostat, and kept at constant temperature until equilibrium is established. The difference of level of the liquid in the two limbs of the tube is read off.

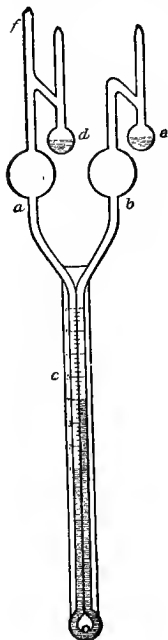

FIG. 105.

EXPERIMENT. — *Determine the Vapour Pressure of Sodium Sulphate Decahydrate (Dissociation Pressure).*

Pure mercury is introduced into the apparatus so as to stand about halfway up each limb of the U-tube. In *d* is placed a quantity of Glauber's salt, *finely powdered and mixed with a small quantity of anhydrous sodium sulphate*. Into *e* introduce a quantity of pure sulphuric acid, and seal off both tubes. Incline the apparatus and exhaust by means of a Fleuss pump. Seal off *f*. Immerse the apparatus completely in the water of a thermostat with transparent sides, and regulate the temperature carefully to about 28° . Read the difference in the level of the liquid in the two limbs of the tensimeter after equilibrium has been established. Then raise the

temperature degree by degree, and at each point determine the difference of level in the two limbs. Continue the determinations up to 35° to 36° . Represent the results graphically.

EXPERIMENT.—*Determine the Transition Point for Glauber's Salt and Anhydrous Sodium Sulphate.*

At the transition point, the vapour pressure of the crystals $\text{Na}_2\text{SO}_4 \cdot 10\text{H}_2\text{O}$ must become equal to that of the solution saturated for the decahydrate and the anhydrous salt. To test this, the bend of the tensimeter is filled with bromonaphthalene, and the bulbs *d* and *e* are charged with dry powdered crystals of $\text{Na}_2\text{SO}_4 \cdot 10\text{H}_2\text{O}$, and with crystals moistened with a little water, so as to give a saturated solution. The apparatus is exhausted and sealed up as before. It is placed in a thermostat at about 25° , and the difference of pressure in the two limbs read off when it has become constant. The temperature is then raised degree by degree, and the difference of level of the liquid in the two tubes read off at each temperature.

References.—Richards and collaborators, *Proc. Amer. Acad.*, Vols. 34, 38, 43 and 47. *Zeitschr. physikal. Chem.*, 1898, 28, 690; 1899, 28, 313; 1903, 43, 465; 1908, 61, 313; *J. Amer. Chem. Soc.*, 1914, 36, 485. Van't Hoff and van Deventer, *Zeitschr. physikal. Chem.*, 1887, 1, 173, 185. Cumming, *Trans. Chem. Soc.*, 1909, 95, 1772.

APPENDIX

INTERNATIONAL ATOMIC WEIGHTS (1914).

		0 = 16.				0 = 16.
Aluminium	Al	27·1		Neodymium	Nd	144·3
Antimony	Sb	120·2		Neon	Ne	20·2
Argon	A	39·88		Nickel	Ni	58·68
Arsenic	As	74·96		Nitrogen	N	14·01
Barium	Ba	137·37		Osmium	Os	190·9
Bismuth	Bi	208·0		Oxygen	O	16·00
Boron	B	11·0		Palladium	Pd	106·7
Bromine	Br	79·92		Phosphorus	P	31·04
Cadmium	Cd	112·40		Platinum	Pt	195·2
Cæsium	Cs	132·81		Potassium	K	39·10
Calcium	Ca	40·07		Praseodymium	Pr	140·6
Carbon	C	12·00		Radium	Ra	226·4
Cerium	Ce	140·25		Rhodium	Rh	102·9
Chlorine	Cl	35·46		Rubidium	Rb	85·45
Chromium	Cr	52·0		Ruthenium	Ru	101·7
Cobalt	Co	58·97		Samarium	Sa	150·4
Copper	Cu	63·57		Scandium	Sc	44·1
Fluorine	F	19·0		Selenium	Se	79·2
Gallium	Ga	69·9		Silicon	Si	28·3
Germanium	Ge	72·5		Silver	Ag	107·88
Glucinum	Gl	9·1		Sodium	Na	23·00
Gold	Au	197·2		Strontium	Sr	87·63
Helium	He	3·99		Sulphur	S	32·07
Hydrogen	H	1·008		Tantalum	Ta	181·5
Indium	In	114·8		Tellurium	Te	127·5
Iodine	I	126·92		Thallium	Tl	204·0
Iridium	Ir	193·1		Thorium	Th	232·4
Iron	Fe	55·84		Tin	Sn	119·0
Krypton	Kr	82·92		Titanium	Ti	48·1
Lanthanum	La	139·0		Tungsten	W	184·0
Lead	Pb	207·10		Uranium	U	238·5
Lithium	Li	6·94		Vanadium	V	51·0
Magnesium	Mg	24·32		Xenon	Xe	130·2
Manganese	Mn	54·93		Zinc	Zn	65·37
Mercury	Hg	200·6		Zirconium	Zr	90·6
Molybdenum	Mo	96·0				

TABLE I.
TRANSITION POINTS OF SALT HYDRATES.

	Temperature on hydrogen scale.	Temperature on mercury thermometer.
$\text{Na}_2\text{CrO}_4, 10\text{H}_2\text{O} \longleftrightarrow \text{Na}_2\text{CrO}_4, 6\text{H}_2\text{O}$	19·63°	19·71°
$\text{Na}_2\text{CO}_3, 10\text{H}_2\text{O} \longleftrightarrow \text{Na}_2\text{CO}_3, 7\text{H}_2\text{O}$	32·02°	32·12°
$\text{Na}_2\text{SO}_4, 10\text{H}_2\text{O} \longleftrightarrow \text{Na}_2\text{SO}_4$	32·38°	32·48°
$\text{NaBr}, 2\text{H}_2\text{O} \longleftrightarrow \text{NaBr}$	50·67°	50·78°
$\text{MnCl}_2, 4\text{H}_2\text{O} \longleftrightarrow \text{MnCl}_2, 2\text{H}_2\text{O}$	58·09°	58·33°

TABLE II.
HEATING LIQUIDS.

	B.-p.		B.-p.
Benzene	80°	Aniline	184°
Water	100°	<i>o</i> -Toluidine	200°
Toluene	110°	Nitrobenzene	209°
Xylene (commercial)	ca. 138°	Naphthalene	218°
<i>m</i> -Xylene	139°	Quinoline	238°

TABLE III.
VISCOSITIES OF LIQUIDS (IN C.G.S. UNITS).

Substance.	0°.	10°.	20°.	30°.	40°.	50°.
Alcohol, methyl	·00813	·00686	·00591	·00515	·00450	·00396
„ ethyl	·0177	·0145	·0119	·00989	·00827	·00697
Benzene	·00902	·00759	·00649	·00562	·00492	·00437
Carbon tetrachloride	·0135	·0113	·00969	·00841	·00738	·00653
Chloroform	·00700	·00626	·00564	·00511	·00465	·00426
Water	·01793	·01311	·01006	·00800	·00657	·00550

TABLE IV.

SURFACE TENSION OF LIQUIDS (IN DYNES PER CM.).

Liquid.	Temperature.	Surface tension.
Alcohol, ethyl . . .	10°	22.50
" " . . .	20°	21.70
" " . . .	40°	20.09
Benzene	11.4°	28.83
"	31.2°	26.68
"	55.1°	23.53
Carbon tetrachloride .	11.8°	26.93
" "	23.8°	25.74
" "	33.0°	24.60
Ethyl acetate	10°	24.50
" "	20°	23.27
" "	30°	22.04
Water	10°	74.30
"	20°	72.69
"	40°	69.33

TABLE V.

IONIC CONDUCTIVITIES AT INFINITE DILUTION.

Cation.	18°.	25°.	Anion.	18°.	25°.
	Ag ⁺	54.5		63.0	Br ⁻
H ⁺	314	347	Cl ⁻	65.5	75.5
K ⁺	64.5	74.0	I ⁻	66.4	76.2
Na ⁺	43.5	51.0	NO ₃ ⁻	62.0	71.0
$\frac{1}{2}$ Ba ⁺⁺	57.3	66.1	OH ⁻	174	196
$\frac{1}{2}$ Ca ⁺⁺	52.0	60.8	$\frac{1}{2}$ C ₂ O ₄ ⁼⁼	63.0	75.8
$\frac{1}{2}$ Pb ⁺⁺	61.5	72.0	$\frac{1}{2}$ SO ₄ ⁼⁼	68.3	79.2

	0	1	2	3	4	5	6	7	8	9	1	2	3	4	5	6	7	8	9
10	0000	0043	0086	0128	0170	0212	0253	0294	0334	0374	4	8	12	17	21	25	29	33	37
11	0414	0453	0492	0531	0569	0607	0645	0682	0719	0755	4	8	11	15	19	23	26	30	34
12	0792	0828	0864	0899	0934	0969	1004	1038	1072	1106	3	7	10	14	17	21	24	28	31
13	1139	1173	1206	1239	1271	1303	1335	1367	1399	1430	3	6	10	13	16	19	23	26	29
14	1461	1492	1523	1553	1584	1614	1644	1673	1703	1732	3	6	9	12	15	18	21	24	27
15	1761	1790	1818	1847	1875	1903	1931	1959	1987	2014	3	6	8	11	14	17	20	22	25
16	2041	2068	2095	2122	2148	2175	2201	2227	2253	2279	3	5	8	11	13	16	18	21	24
17	2304	2330	2355	2380	2405	2430	2455	2480	2504	2529	2	5	7	10	12	15	17	20	22
18	2553	2577	2601	2625	2648	2672	2695	2718	2742	2765	2	5	7	9	12	14	16	19	21
19	2788	2810	2833	2856	2878	2900	2923	2945	2967	2989	2	4	7	9	11	13	16	18	20
20	3010	3032	3054	3075	3096	3118	3139	3160	3181	3201	2	4	6	8	11	13	15	17	19
21	3222	3243	3263	3284	3304	3324	3345	3365	3385	3404	2	4	6	8	10	12	14	16	18
22	3424	3444	3464	3483	3502	3522	3541	3560	3579	3598	2	4	6	8	10	12	14	15	17
23	3617	3636	3655	3674	3692	3711	3729	3747	3766	3784	2	4	6	7	9	11	13	15	17
24	3802	3820	3838	3856	3874	3892	3909	3927	3945	3962	2	4	5	7	9	11	12	14	16
25	3979	3997	4014	4031	4048	4065	4082	4099	4116	4133	2	3	5	7	9	10	12	14	15
26	4150	4166	4183	4200	4216	4232	4249	4265	4281	4298	2	3	5	7	8	10	11	13	15
27	4314	4330	4346	4362	4378	4393	4409	4425	4440	4456	2	3	5	6	8	9	11	13	14
28	4472	4487	4502	4518	4533	4548	4564	4579	4594	4609	2	3	5	6	8	9	11	12	14
29	4624	4639	4654	4669	4683	4698	4713	4728	4742	4757	1	3	4	6	7	9	10	12	13
30	4771	4786	4800	4814	4829	4843	4857	4871	4886	4900	1	3	4	6	7	9	10	11	13
31	4914	4928	4942	4955	4969	4983	4997	5011	5024	5038	1	3	4	6	7	8	10	11	12
32	5051	5065	5079	5092	5105	5119	5132	5145	5159	5172	1	3	4	5	7	8	9	11	12
33	5185	5198	5211	5224	5237	5250	5263	5276	5289	5302	1	3	4	5	6	8	9	10	12
34	5315	5328	5340	5353	5366	5378	5391	5403	5416	5428	1	3	4	5	6	8	9	10	11
35	5441	5453	5465	5478	5490	5502	5514	5527	5539	5551	1	2	4	5	6	7	9	10	11
36	5563	5575	5587	5599	5611	5623	5635	5647	5658	5670	1	2	4	5	6	7	8	10	11
37	5682	5694	5705	5717	5729	5740	5752	5763	5775	5786	1	2	3	5	6	7	8	9	10
38	5798	5809	5821	5832	5843	5855	5866	5877	5888	5899	1	2	3	5	6	7	8	9	10
39	5911	5922	5933	5944	5955	5966	5977	5988	5999	6010	1	2	3	4	5	7	8	9	10
40	6021	6031	6042	6053	6064	6075	6085	6096	6107	6117	1	2	3	4	5	6	8	9	10
41	6128	6138	6149	6160	6170	6180	6191	6201	6212	6222	1	2	3	4	5	6	7	8	9
42	6232	6243	6253	6263	6274	6284	6294	6304	6314	6325	1	2	3	4	5	6	7	8	9
43	6335	6345	6355	6365	6375	6385	6395	6405	6415	6425	1	2	3	4	5	6	7	8	9
44	6435	6444	6454	6464	6474	6484	6493	6503	6513	6522	1	2	3	4	5	6	7	8	9
45	6532	6542	6551	6561	6571	6580	6590	6599	6609	6618	1	2	3	4	5	6	7	8	9
46	6628	6637	6646	6656	6665	6675	6684	6693	6702	6712	1	2	3	4	5	6	7	7	8
47	6721	6730	6739	6749	6758	6767	6776	6785	6794	6803	1	2	3	4	5	5	6	7	8
48	6812	6821	6830	6839	6848	6857	6866	6875	6884	6893	1	2	3	4	4	5	6	7	8
49	6902	6911	6920	6928	6937	6946	6955	6964	6972	6981	1	2	3	4	4	5	6	7	8
50	6990	6998	7007	7016	7024	7033	7042	7050	7059	7067	1	2	3	3	4	5	6	7	8
51	7076	7084	7093	7101	7110	7118	7126	7135	7143	7152	1	2	3	3	4	5	6	7	8
52	7160	7168	7177	7185	7193	7202	7210	7218	7226	7235	1	2	2	3	4	5	6	7	7
53	7243	7251	7259	7267	7275	7284	7292	7300	7308	7316	1	2	2	3	4	5	6	6	7
54	7324	7332	7340	7348	7356	7364	7372	7380	7388	7396	1	2	2	3	4	5	6	6	7

* The following Tables of Logarithms are reprinted from Castle's "Mathematical Tables for Ready Reference," by permission of Messrs. Macmillan & Co., Ltd.

	0	1	2	3	4	5	6	7	8	9	1	2	3	4	5	6	7	8	9
55	7404	7412	7419	7427	7435	7443	7451	7459	7466	7474	I	2	2	3	4	5	5	6	7
56	7482	7490	7497	7505	7513	7520	7528	7536	7543	7551	I	2	2	3	4	5	5	6	7
57	7559	7566	7574	7582	7589	7597	7604	7612	7619	7627	I	2	2	3	4	5	5	6	7
58	7634	7642	7649	7657	7664	7672	7679	7686	7694	7701	I	1	2	3	4	4	5	6	7
59	7709	7716	7723	7731	7738	7745	7752	7760	7767	7774	I	1	2	3	4	4	5	6	7
60	7782	7789	7796	7803	7810	7818	7825	7832	7839	7846	I	1	2	3	4	4	5	6	6
61	7853	7860	7868	7875	7882	7889	7896	7903	7910	7917	I	1	2	3	4	4	5	6	6
62	7924	7931	7938	7945	7952	7959	7966	7973	7980	7987	I	1	2	3	3	4	5	6	6
63	7993	8000	8007	8014	8021	8028	8035	8041	8048	8055	I	1	2	3	3	4	5	5	6
64	8062	8069	8075	8082	8089	8096	8102	8109	8116	8122	I	1	2	3	3	4	5	5	6
65	8129	8136	8142	8149	8156	8162	8169	8176	8182	8189	I	1	2	3	3	4	5	5	6
66	8195	8202	8209	8215	8222	8228	8235	8241	8248	8254	I	1	2	3	3	4	5	5	6
67	8261	8267	8274	8280	8287	8293	8299	8306	8312	8319	I	1	2	3	3	4	5	5	6
68	8325	8331	8338	8344	8351	8357	8363	8370	8376	8382	I	1	2	3	3	4	5	5	6
69	8388	8395	8401	8407	8414	8420	8426	8432	8439	8445	I	1	2	2	3	4	4	5	6
70	8451	8457	8463	8470	8476	8482	8488	8494	8500	8506	I	1	2	2	3	4	4	5	6
71	8513	8519	8525	8531	8537	8543	8549	8555	8561	8567	I	1	2	2	3	4	4	5	5
72	8573	8579	8585	8591	8597	8603	8609	8615	8621	8627	I	1	2	2	3	4	4	5	5
73	8633	8639	8645	8651	8657	8663	8669	8675	8681	8686	I	1	2	2	3	4	4	5	5
74	8692	8698	8704	8710	8716	8722	8727	8733	8739	8745	I	1	2	2	3	4	4	5	5
75	8751	8756	8762	8768	8774	8779	8785	8791	8797	8802	I	1	2	2	3	3	4	5	5
76	8808	8814	8820	8825	8831	8837	8842	8848	8854	8859	I	1	2	2	3	3	4	5	5
77	8865	8871	8876	8882	8887	8893	8899	8904	8910	8915	I	1	2	2	3	3	4	4	5
78	8921	8927	8932	8938	8943	8949	8954	8960	8965	8971	I	1	2	2	3	3	4	4	5
79	8976	8982	8987	8993	8998	9004	9009	9015	9020	9025	I	1	2	2	3	3	4	4	5
80	9031	9036	9042	9047	9053	9058	9063	9069	9074	9079	I	1	2	2	3	3	4	4	5
81	9085	9090	9096	9101	9106	9112	9117	9122	9128	9133	I	1	2	2	3	3	4	4	5
82	9138	9143	9149	9154	9159	9165	9170	9175	9180	9186	I	1	2	2	3	3	4	4	5
83	9191	9196	9201	9206	9212	9217	9222	9227	9232	9238	I	1	2	2	3	3	4	4	5
84	9243	9248	9253	9258	9263	9269	9274	9279	9284	9289	I	1	2	2	3	3	4	4	5
85	9294	9299	9304	9309	9315	9320	9325	9330	9335	9340	I	1	2	2	3	3	4	4	5
86	9345	9350	9355	9360	9365	9370	9375	9380	9385	9390	I	1	2	2	3	3	4	4	5
87	9395	9400	9405	9410	9415	9420	9425	9430	9435	9440	O	1	2	2	3	3	4	4	
88	9445	9450	9455	9460	9465	9469	9474	9479	9484	9489	O	1	2	2	3	3	4	4	
89	9494	9499	9504	9509	9513	9518	9523	9528	9533	9538	O	1	2	2	3	3	4	4	
90	9542	9547	9552	9557	9562	9566	9571	9576	9581	9586	O	1	2	2	3	3	4	4	
91	9590	9595	9600	9605	9609	9614	9619	9624	9628	9633	O	1	2	2	3	3	4	4	
92	9638	9643	9647	9652	9657	9661	9666	9671	9675	9680	O	1	2	2	3	3	4	4	
93	9685	9689	9694	9699	9703	9708	9713	9717	9722	9727	O	1	2	2	3	3	4	4	
94	9731	9736	9741	9745	9750	9754	9759	9763	9768	9773	O	1	2	2	3	3	4	4	
95	9777	9782	9786	9791	9795	9800	9805	9809	9814	9818	O	1	2	2	3	3	4	4	
96	9823	9827	9832	9836	9841	9845	9850	9854	9859	9863	O	1	2	2	3	3	4	4	
97	9868	9872	9877	9881	9886	9890	9894	9899	9903	9908	O	1	2	2	3	3	4	4	
98	9912	9917	9921	9926	9930	9934	9939	9943	9948	9952	O	1	2	2	3	3	4	4	
99	9956	9961	9965	9969	9974	9978	9983	9987	9991	9996	O	1	2	2	3	3	3	4	

INDEX

A

- Air-free water, 296
- Affinity constant, 188
- Approximate numbers, calculation with, 3
- Association factor for liquids, 90
- Atomic weights, 317

B

- Balance, 19
- , determination of the zero point, 20
- , sensitiveness of a, 22
- Baryta solutions, preparation of, 162
- Basicity of acids, 196
- Boiling-point determinations, 138
- Bomb, calorimetric, 286
- Buoyancy of air, correction for, 27
- Burettes, calibration of, 35

C

- Calculation, methods of, 6
- of results and errors, 1
- Calorie, 276
- , centuple, 276
- , large, 276
- Calorimeter, 276, 288
- Cell constant, 180

- Cells, gas, 242
- Circulating pump, 79
- Circulation of water, 79
- Combustion, heat of, 288
- Commutator, 171
- Concentration cells, 239
- Conductance, specific, 166
- Conductivities, ionic, 319
- Conductivity, equivalent, 166
- , molecular, 166, 188
- of electrolytes, 165, 167
- of solutions of potassium chloride, 181
- vessel, 169
- water, 179
- Constant level apparatus, 70
- Copper voltameter, 208
- Critical solution temperature, 301
- Cryoscopic method of determining molar weights, 125

D

- Decomposition potential, 251
- Density, calculation of the, 43
- of benzene, 92
- of gases and vapours, 45
- of liquids, 39
- of water, 44
- , relative, 39
- Diazonium salts, decomposition of, 267

Dilatometer, 309
 Discharge potential of ions, 252, 254
 Dissociation constant of an acid, 188
 Distribution coefficient, 154
 — of a substance between two non-miscible solvents, 153
 Division, abbreviated, 9

E

Electrode, calomel, 228
 — potentials, 230
 — —, influence of concentration on, 237
 — —, measurement of, 227
 Electrodes, cleaning, 183
 — of platinum on glass, 244
 —, preparation of, 232
 —, testing the uniformity of, 232
 Electrometer, capillary, 220
 Electromotive force, 213
 — —, influence of concentration on, 237
 — —, measurement of, 214
 — — of a cell, seat of, 226
 Error, maximum apparent, 2
 — of observation, determination of, 17
 Errors, 13
 —, accidental, 13
 —, constant, 13
 —, mean, 18
 — of observation, 13
 — — —, influence of, on the final result, 14

F

Flasks, marking of, 32
 Freezing-point apparatus, 126

Freezing-point method of determining molar weights, 125

G

Gas cells, 242
 — —, electrode vessels for, 245
 Geissler tube, 100
 Gravity, specific, 39

H

Heating liquids, 318
 Heat of combustion, 285
 — of neutralization, 278, 281
 — of solution, 283
 Helium, spectrum of, 124
 Hydrogen, spectrum of, 124
 Hydrolysis of esters by acids, 258
 — of salts, measurement of, 158, 203, 265

I

Induction coil, 168
 Interpolation, 14
 Inversion of cane sugar, velocity of, 262
 Ionic conductivities, 319
 Ionization constant, 190
 —, degree of, 190
 — of acetic acid, 191
 — of benzoic acid, 191
 — of mandelic acid, 191
 — of succinic acid, 191

J

Joule, 278

K

- Key, Morse, 221
 — tapping, 221
 —, three-way, 225
 —, two-way, 224
 Kilojoule, 278

L

- Landsberger-Walker apparatus, 143
 Light, monochromatic, 99
 Logarithms, errors of, 12
 Logarithm tables, 320

M

- Mapping spectra, 122
 Measuring bridge, 173
 — —, calibration of, 174
 — flasks, calibration of, 30
 Mercury pipette, 74
 —, purification of, 218
 — seal, 269
 Mixtures, binary, 66
 Molar weight, determination of, by
 boiling-point method, 139
 — —, — —, by distribu-
 tion, 156
 — —, — —, by freezing-
 point method, 125
 — —, — —, by lowering
 of vapour pressure, 149
 — —, — —, by vapour
 density, 45, 48, 53, 58
 — — of substances in solution,
 125
 — —, abnormal, 135
 Multiplication, abbreviated, 6

N

- Neutralization point, determination
 of, by conductivity, 199
 Number of figures to be employed
 in calculation, 1
 Numbers, approximate, calculation
 with, 3

O

- Observation tubes for polarimeter,
 117

P

- Parallax, 38
 Partition, coefficient of, 154
 Pipette, mercury, 74
 Pipettes, calibration of, 32
 Platinizing electrodes, 171
 — solution, 171
 Polarimeter, 114
 —, adjustment of, 118
 Polarimetric measurements, 112
 Pyknometer, 39

R

- Radiation, correction of temperature
 for, 291
 Reaction, order of a, 272
 Reactions of the first order, 258
 — of the second order, 270
 Refractive index, 97
 — — of a liquid, measurement
 of, 97
 Refractivity, atomic, 107
 — of substances in solution, 111
 —, molecular, 98

Refractivity, specific, 98
 Refractometer, Pulfrich's, 101
 Refractometric measurements, 97
 Resistance box, 169
 —, specific, 166
 Rotation, specific, 113

S

Safety tube, 33
 Saponification of esters by alkalis, 270
 Slide rule, 12
 Sodium hydroxide free from carbonate, 197
 Solubility, determination of, 241, 294, 302
 — of a gas in a liquid, 294
 — of a liquid in a liquid, 298
 — of solids in a liquid, 301
 — of sparingly soluble salts, 202, 241
 Spectra, mapping, 122
 Spectrometer, 120
 —, adjustment of, 120
 Spectrometry, 119
 Stalagmometer, 94
 Standard cell, 216
 Steaming vessels, apparatus for, 170
 Stirrers, 76
 Surface energy, molecular, 89
 — —, measurement of, 90
 — — of alcohol, 93
 — — of benzene, 92
 — tension, 88
 — —, by drop method, 93
 — — of liquids, 319

T

Tabloid press, 132

Temperature, regulation of, 71
 Tensimeter, 313
 Thermo-chemical units, 276
 Thermo-chemistry, 275
 Thermometer, Beckmann, 129
 —, —, setting the, 130
 Thermometric method of determining transition points, 308
 Thermo-regulator, 71, 75
 — —, filling and adjusting, 73
 — —, for low temperatures (Foote's), 75
 Thermostats, 68, 69
 —, electrically heated, 80
 Transition points, determination of, 307, 308
 — — of salt hydrates, 318
 Transport numbers, 206

V

Vapour densities, abnormal, 64
 — density, determination of, 49, 54, 59, 62
 — pressure of water, 54
 Velocity of reactions, 256
 Viscosities of liquids, 318
 Viscosity, 83
 —, coefficient of, 84
 — — of benzene, 88
 —, influence of temperature on, 87
 —, relative, 85
 — tube, 84
 Voltmeter, copper, 208
 Volume corresponding with an apparent weight of 1 gm. of water, 30
 Volume, determination of, 19
 Volumetric apparatus, calibration of, 29

W

- Water, apparent weight of 1 c.c., 30
— blower, 76
—, circulation of, 79
— free from carbonic acid, 161
—, ionization of, 248
- Water, vapour pressure of, 54
Weighing by oscillations, 22
Weight, determination of, 19
Weights, calibration of, 24
Weston cell, 216
— —, e.m.f. of, 218
— —, preparation of, 216

THE END

